



CE Made in Italy
DESIGNED AND MANUFACTURED
AT RAASM - ITALY

FLUIDS AND LUBRICATION EQUIPMENT

Automotive Lubrication



Industrial Hose reels



Industrial Pumps



technology, quality, functionality

Catalogue No 219

1st January 2011



**ADVANCED FLUID
MANAGEMENT SOLUTIONS**

founded in 1975



RAASM

FLUIDS AND LUBRICATION EQUIPMENT





General view of RAASM Area in San Zeno di Cassola - Vicenza



**ADVANCED FLUID
MANAGEMENT SOLUTIONS**



DESIGN IS AN

ART

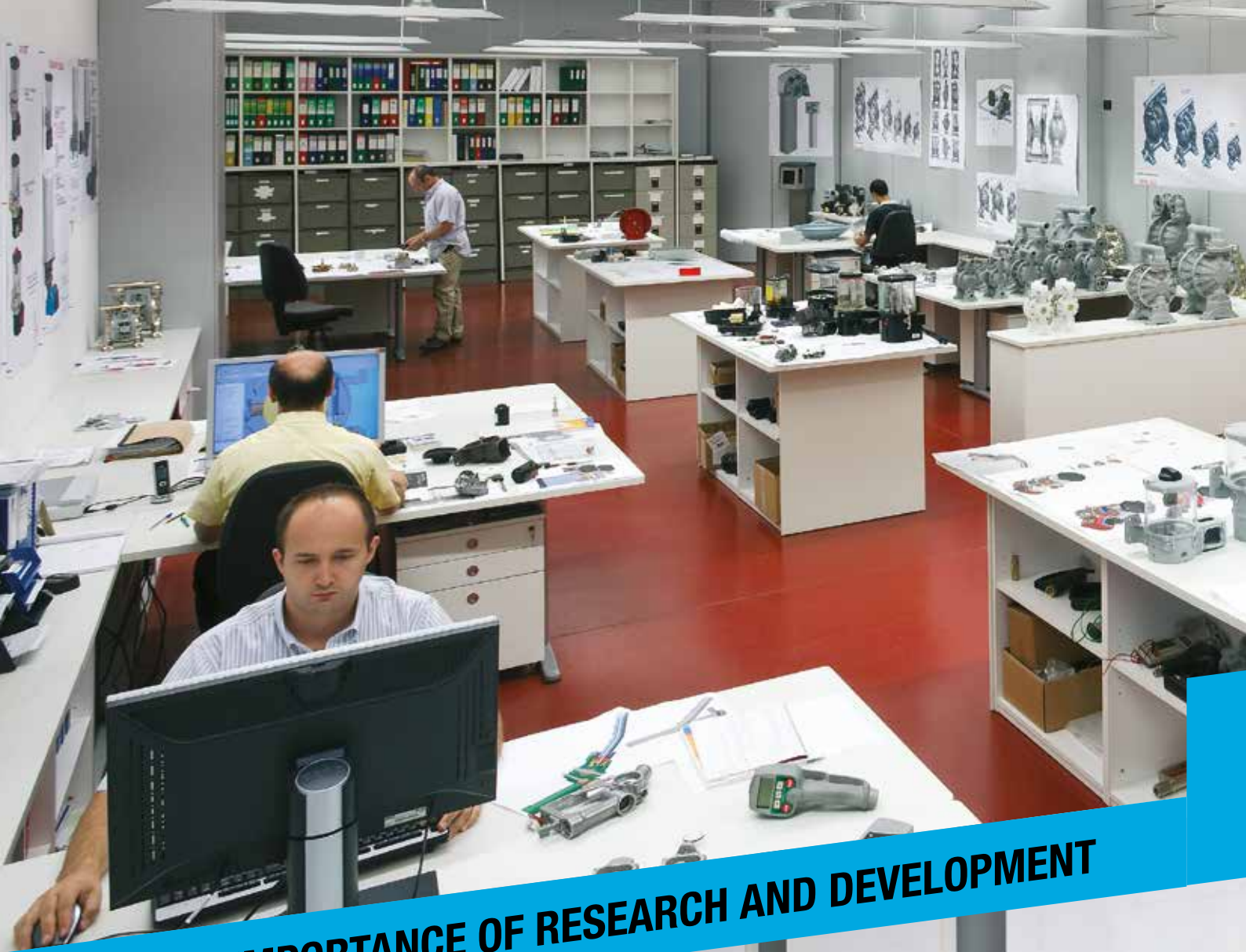

THE IMPORTANCE OF RESEARCH AND DEVELOPMENT





The starting point for the entire production cycle is the research and design of new solutions that will become cutting-edge products.

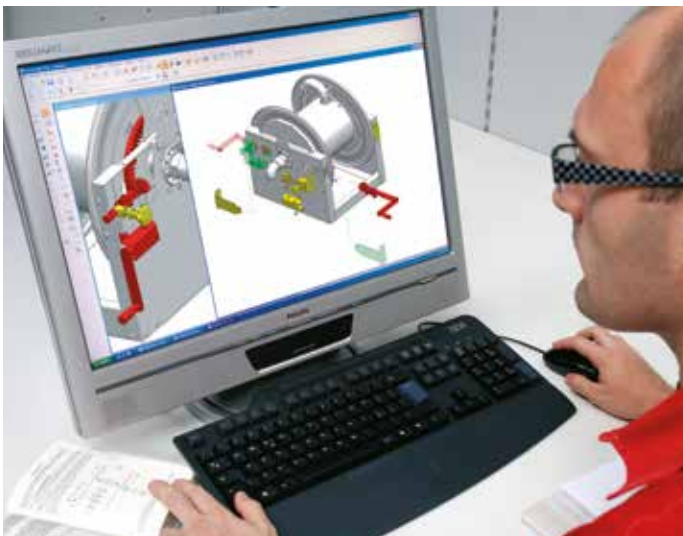



PRODUCTS DEVELOPED AND TESTED IN EVERY SINGLE DETAIL





A sophisticated testing room allows to check carefully the quality of the new products before introduce them in the market.





High precision dies developed in partnership with specialist companies, using cutting edge technology.

FULL ROBOTIZED WELDING





Welding quality is guaranteed by:

- the material used
- a high-tech robot
- an appropriate welding programme



- precise torch positioning
- control of temperature
- testing and a complete visual check of all welds on each product

...FOR THE HIGHEST QUALITY ALSO
IN PAINTING

The painting is guaranteed by innovative systems with lead and heavy metal-free non-toxic polyester resin for exteriors, with average thickness of 80 μ .

The painting is highly resistant to atmospheric agents and impacts.
The painted products undergo "saline mist resistance" corrosion testing according to UNI 9227 standards.



Computerised laser cutting enables the execution of complex work requiring extreme precision.



The excellence of the die-castings is ensured by the consistent quality of the castings obtained by means of computerised control of the presses and castings during the course of production.



Robotised injection moulding of components in thermoplastic material with subsequent structural inspection of the moulded pieces.





Turning, with state of the art machinery, as a result of continuing investment. Allowing the manufacture of complex components.

AN ALWAYS IN THE FOREFRONT REALITY





High precision instruments allow a careful control of the parts produced by evaluating their features: dimensions, hardness, roughness, etc.

CONTROL ROOM FOR BETTER QUALITY





A WAREHOUSE CONSTANTLY WELL-STOCKED
...to grant a fast and efficient spare parts
replacement service

Automated vertical store complete with
travelling lift for storage and handling
of material.

...a static structure for a dynamic system.
Control is carried out by means of company
management software, offering efficiency
and maximum flexibility.



MODULA

MODULA



SYSTEM
LOGISTICS

SYSTEM
LOGISTICS

RAASM

52





Pumps assembling with final control using a special software to verify pump's functionality.

EFFICIENT AND WELL ORGANIZED ASSEMBLY LINES





Careful packaging with special protections to avoid any damage during transport.





A WAREHOUSE CONSTANTLY WELL-STOCKED



Our inventory of finished products allows us to have the most popular items always available and ready to be shipped.



...to provide a fast and efficient order fulfillment

the packaging department prepares the products with packing materials suitable for specific protection requirements. This phase includes a final visual check of each article.



After a careful packaging, products are ready for shipment.



Technical and commercial brochures realized by qualified personnel.

TRAINING COURSE FOR CUSTOMERS AND DISTRIBUTORS

RAASM organizes refresher courses to improve the efficiency of our customer care service.





ONGOING TECHNICAL TRAINING FOR ALL RAASM STAFF



Automotive lubrication

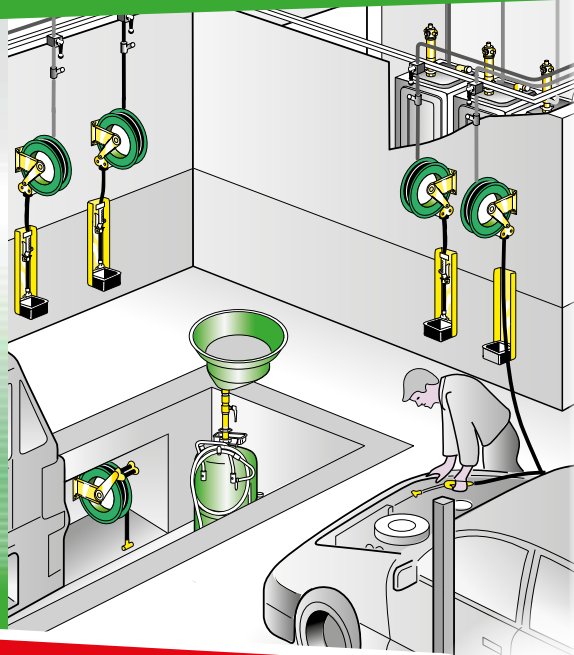

A wide variety of products for lubrication in the automotive, industrial, agricultural, marine and other sectors.

Our products are designed to make work easier and quicker, according to the needs of our customers.

Industrial hose reels

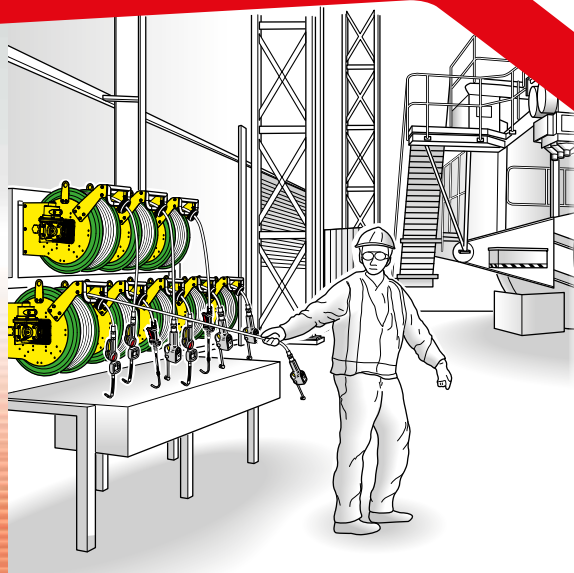

RAASM hose reels enable safe and practical management of any type of hose for use with all types of fluids.

Industrial pumps

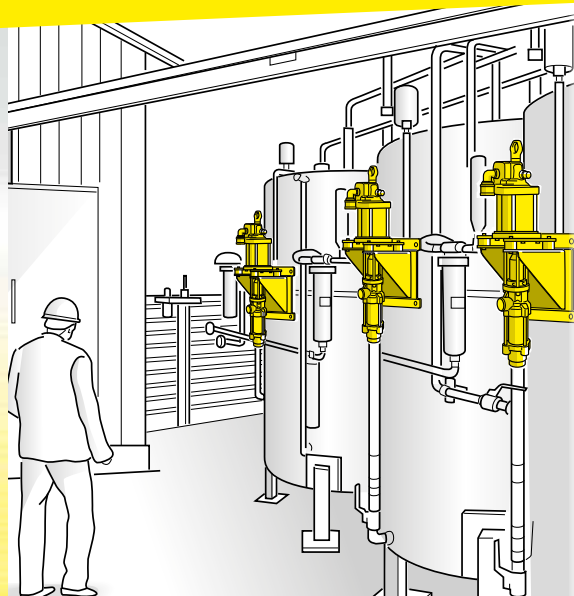

RAASM has created a wide range of industrial pumps to meet the most complex needs in application sectors such as industry, building, mining, shipyards, etc. This large range will certainly have the right pump for your application.

INDEX FAMILIES



1 BRAKE BLEEDING - WASHING - INFLATING page **31**

2 WASTE OIL SUCTION/DRAINERS page **41**



3 MANUAL OIL AND GREASE PUMPS page **59**



4 OIL PUMPS FOR TRANSFERRING AND DISTRIBUTION page **67**



5 GREASE PUMPS AND ACCESSORIES page **115**



6 SERVICE COLUMNS page **133**



7 HOSE REELS AND ACCESSORIES page **143**



8 INDUSTRIAL PUMPS AND ACCESSORIES page **189**



RAASM AUTOMOTIVE
FLUIDS AND LUBRICATION EQUIPMENT



AUTOMOTIVE LUBRICATION





FLUIDS AND LUBRICATION EQUIPMENT



Brake bleeding - washing - inflating



BRAKE - CLUTCH BLEEDING

page 32



PRESSURE SPRAYERS

page 36



WASHING TANK

page 37



TYRE INFLATOR

page 38



Brake-clutch bleeding equipment

with 2 chambers

with 3 chambers

The simplified air-operated two-chamber or three chamber, brake bleeding device is suitable for bleeding the hydraulic brakes and clutches of all motor vehicles. Bleeding can be carried out in a few minutes by just one person. The brake-bleeding device is equipped with an elastic inner membrane which hermetically separates the oil from the air, thus avoiding the risk of emulsion. It is also suitable for systems with braking control and ABS (max. at 1 bar).

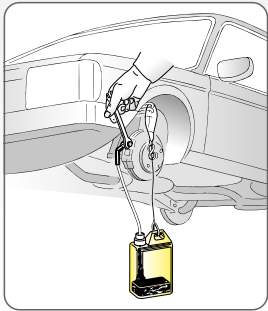

Article		10105	10205	10207	10705	10805	10807
Tank capacity	litres	5	5	5	5	5	5
Set of plugs	Art.	-	11001	11004	-	11001	11004
clutch bleeding tube	Art.	-	10802	10802	-	10802	10802
2 collection containers	Art.	10801	10801	10801	10801	10801	10801
Filler funnel		yes	yes	yes	yes	yes	yes
Max working pressure	bar	2	2	2	2	2	2
Tank max pressure	bar	2	2	2	10	10	10
Delivery hose length	m	3	3	3	3	3	3
Safety valve	bar	3	3	3	10	10	10
Packing	N° - m ³	1 - 0,065	1 - 0,065	1 - 0,065	1 - 0,065	1 - 0,065	1 - 0,065
Weight	kg	8,5	9,5	9,7	10,2	11,2	11,4
Dimensions (A - B - C)	cm	43 - 25 - 65	43 - 25 - 65	43 - 25 - 65	45 - 25 - 65	45 - 25 - 65	45 - 25 - 65

Attention: do not use with mineral oils.

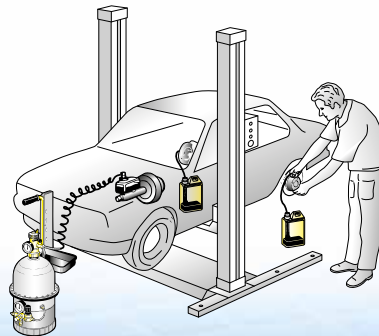

Braking system bleeding phase

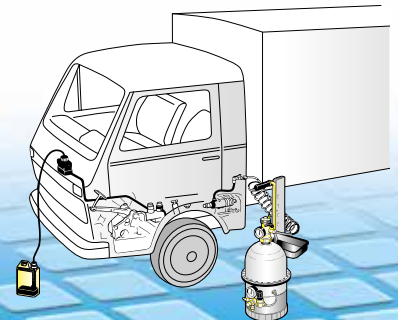

Truck clutch system bleeding phase



Brake bleeder operation

2 chambers operation

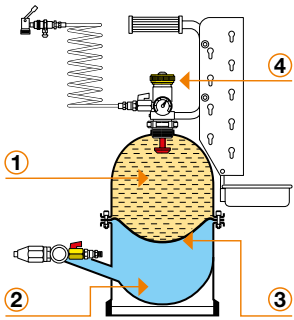

The brake-bleeding device is equipped with an elastic inner membrane (3) which hermetically separates the oil contained in the oil tank (1), from the air contained in the air "expansion" tank (2), thus avoiding the risk of emulsion (working pressure 1 - 2 bar controllable on the upper pressure gauge).

The oil tank (4) filler cap is equipped with a "reserve indicator" that signals when the fluid is finishing, and an air venting valve to be used in the device activation phase.

3 chambers operation

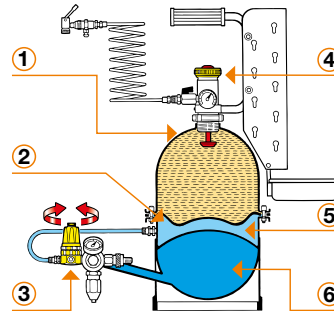

The brake-bleeding device is equipped with an elastic inner membrane (2) which hermetically separates the oil contained in the oil tank (1), from the air contained in the air "expansion" tank (5), thus avoiding the risk of emulsion. It is also equipped with a third air reserve tank (high pressure air 8-10 bar) (6) which, delivered by means of a pressure regulator (3), enables several bleeding operations to be carried out at a constant pressure without having to recharge the device.

The oil tank (4) filler cap is equipped with a "reserve indicator" that signals when the fluid is finishing, and an air venting valve to be used in the device activation phase.

Procedures for applying the connection plugs



Before bleeding it is important to fill the brake fluid reservoir by means of the brake bleeder quick-release connector.

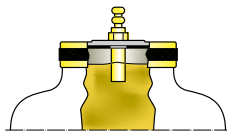

The extended nozzle of the plug must be immersed in the fluid to avoid sprays or air and oil emulsions.



Connect the brake bleeding device to the reservoir by means of the quick-release connector.

11000/ LIST OF SCREW PLUGS FOR CARS

ALFA.....	A-D-L	JEEP.....	W	PEUGEOT.....	D-F-M
AUDI.....	D	KIA.....	D	PORSCHE.....	C-D
AUSTIN MORRIS.....	A-D-T	LAMBORGHINI.....	D-H-W	RENAULT.....	D-G-I-M
AUTOBIANCHI.....	B-H	LADA.....	H	ROVER.....	A-D-W
BMW.....	D-W	LANCIA.....	D-H	SAAB.....	D
CITROËN.....	D-E-I	LAND ROVER.....	T-W	SEAT.....	D-H
CHRYSLER.....	W	LEYLAND.....	A	SUBARU.....	U-W
DAEWOO.....	D-W	MASERATI.....	D-G-L	SUZUKI.....	D-W
FERRARI.....	D-G-H	MITSUBISHI.....	K-U	TALBOT.....	D-F
FIAT.....	A-B-D-H-I	MAZDA.....	D-W	TOYOTA.....	W
FORD.....	A-D-T	MERCEDES.....	D	TRIUMPH.....	T
HYUNDAI.....	W	MG.....	W	VAUXHALL.....	A
INOCENTI.....	A-D-L	NISSAN.....	W	VOLKSWAGEN.....	C-D
JAGUAR.....	L	OPEL.....	D-F	VOLVO.....	D-G-U

11000/ LIST OF SCREW PLUGS FOR TRUCKS

ASTRA.....	H	FIAT.....	A-B-D-F-H-I-P	RENAULT.....	D-F-I-X-Z
BEDFORD.....	A-G-L	FORD.....	D-G	SCANIA.....	D-G
BERLIET.....	D-F-T-X-Z	IVECO.....	D-H-L	VOLVO.....	R
DAF.....	D	MERCEDES.....	D		

11003/ LIST OF PRESSURE PLUGS FOR CARS

HONDA.....	Art. 11003/4, /6	MAZDA.....	Art. 11003/5, /9	SUZUKI.....	Art. 11003/7
KIA.....	Art. 11003/5, /8	OPEL.....	Art. 11003/3	TOYOTA.....	Art. 11003/1, /2
LEXUS.....	Art. 11003/1	ROVER.....	Art. 11003/6		



Screw connection plugs

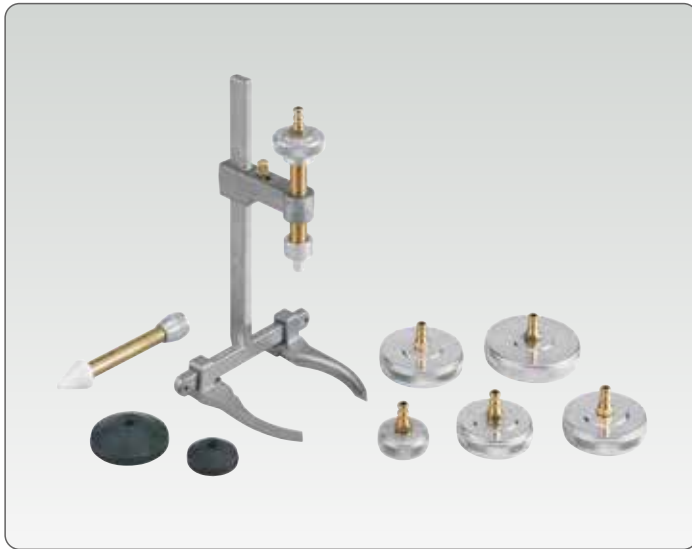

Art. 11001

Series of standard screw connection plugs, supplied with Art. 10205 or Art. 10805 (refer to page 32), consisting of:
 - 5 screw plugs: 11000/A/D/F/I/T
 - 1 universal plug 11000/W

Note: the above plugs can also be supplied individually. The universal plug 11000/W can be used on many types of cars and trucks in addition to those given in the plug list (refer to page 33)

Application examples of universal plug 11000/W

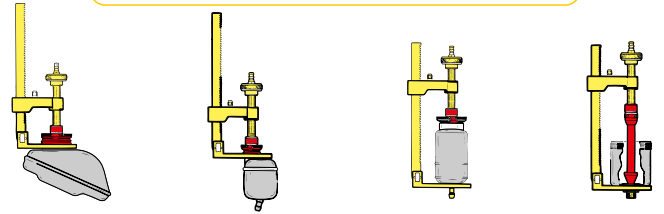









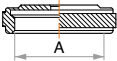
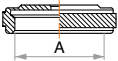













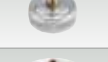

Art. 11002

Series of special screw connection plugs, consisting of:
 11000/B/C/E/G/H/K/L/M/P/R/U/X/Y/Z

Note: the series of special plugs is only supplied by request

List of screw plugs supplyable individually

	Article	Plug series	Diameter (A) mm		Article	Plug series	Diameter (A) mm
	11000/A	type A	25		11000/M	type M	68,5
	11000/B	type B	21,5		11000/P	type P	77
	11000/C	type C	26,5		11000/R	type R	33,5
	11000/D	type D	43		11000/T	type T	44
	11000/E	type E	48		11000/U	type U	76
	11000/F	type F	52,5		11000/X	type X	44,5
	11000/G	type G	64		11000/Y	type Y	34,5
	11000/H	type H	41,5		11000/Z	type Z	58,5
	11000/I	type I	59		11000/W Universal plug W with 3 tapered plugs:	<ul style="list-style-type: none">  1) \varnothing 20 mm  2) \varnothing 28 mm  3) \varnothing 45 mm 	
	11000/K	type K	61,5				
	11000/L	type L	76,5				

Note: to choose the connection plug see the "Brake bleeder plug list" tables (refer to page 33)



Pressure connection plugs

Art. 11004







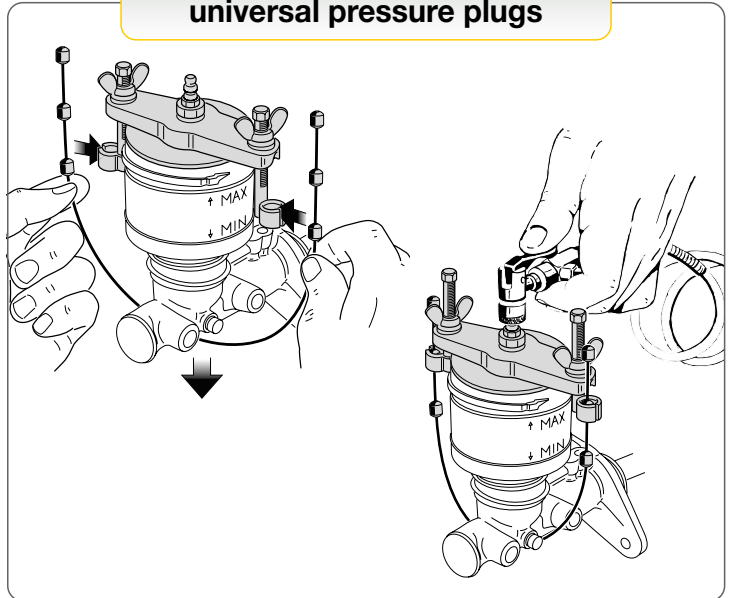



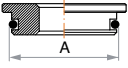

Adjustable universal bracket (Art.11003) with series of pressure plugs 11003/1/2/3/4/5/6/7/8/9



Application examples of universal pressure plugs



List of pressure plugs suppliable individually

	Article	Plug series	Diameter (A) mm	Article	Description
	11003/1	pressure	42,2 42,5		11003 Adjustable universal bracket for pressure plugs.
	11003/2	pressure	42,8		
	11003/3	pressure	53,8 54		
	11003/4	pressure	56		10801 Brake fluid collection containers, complete with transparent tube and 90° flexible attachment for connection to the bleeder valve.
	11003/5	pressure	65,7		
	11003/6	pressure	74,2		
	11003/7	pressure	58,8		10802 Clutch bleeding connection tube, length 600 mm.
	11003/8	pressure	33,7		
	11003/9	pressure	35,8		

Note: to choose the connection plug see the "Brake bleeder plug list" tables (refer to page 33)



Non-toxic pressure sprayers

Painted carbon steel

Stainless steel AISI 304

Devices for the **non-toxic spraying** of low viscosity detergent liquids, such as lubrication oils and similar. Suitable for washing motor vehicles, graphiting, lubricating, delivering dismantling oils, etc. Filled to 3/4 their capacity with the required liquid and pressurised with air at 6 - 8 bar, they work independently without requiring continuous connection to the compressed air line.



Art. 24891
Antisplash funnel



Painted

Polished

Article		22017	22024	23024	23025
Tank capacity	litri	16	24	24	24
Fluids		Oil and similar		Lubricants and detergents	
Delivery hose length	m	5	5	5	5
Max working pressure	bar	10	8	8	8
Gun length	m	0,65	0,65	0,65	0,65
Safety valve	bar	10	8	8	8
Level gauge		si	si	si	si
Spray gun	Art.	24805	24805	24806	24806
Spray nozzle	Art.	24801	24801	24801	24801
Antisplash funnel	Art.	24891	24891	24891	24891
Packing	N° - m ³	1 - 0,080	1 - 0,090	1 - 0,090	1 - 0,090
Weight	kg	9,8	13	12,8	12,8
Dimensions (A - B - C)	cm	25,5 - 22,5 - 95	28 - 33 - 92	28 - 33 - 92	28 - 33 - 92



Attention: Aggressive liquids can be used as long as they are compatible with the materials that are part of the item and after approval by the RAASM technical office.

Attention: Fluids of Group I cannot be used (Directive 2014/68/EU).



Spraying of detergent for washing engines



Spraying antioxidant, oil, diesel oil on mechanical parts



Washing tank

Universal washing tank for quick washing of mechanical parts and components in general.

The low-pressure pneumatic system enables:

- continuous liquid detergent flow with brush for thorough washing
- washing by dipping, with the parts dipped in the liquid detergent in the tank.

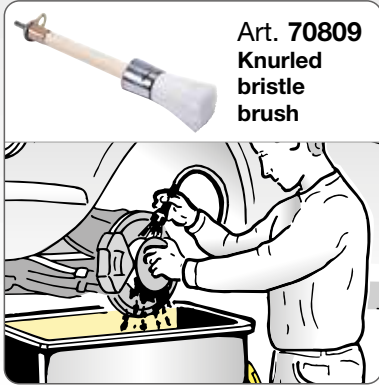

Art. 70809
Knurled
bristle
brush

Important: do not use corrosive liquids with flashpoint below 55°C, that can give off toxic and harmful fumes.

Use specific chemical products for washing mechanical parts, according to the instructions supplied by the manufacturer



removable
cover

Article		70365
Tank capacity	litres	65
Washing tank capacity	litres	50
Max working pressure	bar	0,5
Required quantity of liquid	litres	50
Max blowing gun pressure	bar	12
Knurled bristle brush	Art.	70809
Packing	N° - m ³	2 - 0,290
Weight	kg	47,1
Dimensions (A - B - C)	cm	51 - 67 - 107



Details and advantages

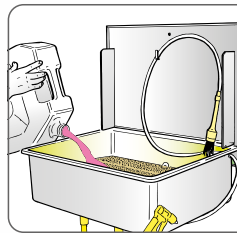

For correct use, add 48 - 52 litres of detergent liquid

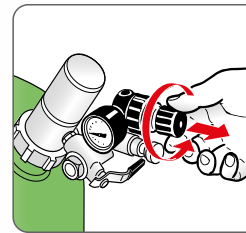

The pneumatic systems works at low pressure **0,5 bar**, consuming very little air

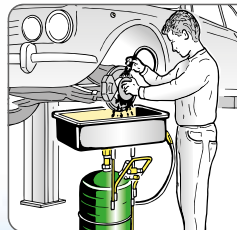

Washing with brush, with continuous liquid flow

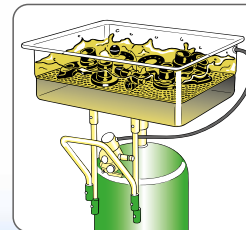

Dip washing, with parts placed in the tank

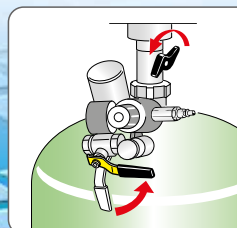

Brush or dip wash management unit

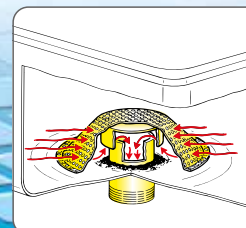

Decanting filter/screen



Portable tyre inflator

automatic charging

standard charging

Type-approved tyre inflator for checking and restoring the pressure of any type of tyre.

13 litres tank is available with standard or automatic charger, whereas **24 litres** tank is available only with standard charger.

Tyre pressure checking and inflation operations are carried out with the gun equipped with pressure gauge \varnothing 60 mm with scale 0 - 10 bar.



Article		52013	52015	53016	52024	53024
Tank capacity	litres	13	13	13	24	24
Max tank pressure	bar	10	10	10	8	8
Calibrated safety valve	bar	10	10	10	8	8
Manometer \varnothing 50 tank pressure	bar	0 - 10	0 - 10	0 - 10	0 - 10	0 - 10
Max working pressure	bar	7	7	7	7	7
Manometer working pressure		0 - 10 bar supplied with the inflating group	0 - 10 bar supplied with the inflating gun	0 - 10 bar supplied with the inflating gun	0 - 10 bar supplied with the inflating gun	0 - 10 bar supplied with the inflating gun
Working temperature	$^{\circ}\text{C}$	-20° +60°	-20° +60°	-20° +60°	-20° +60°	-20° +60°
Inflating hose length	m	1,2	1,2	1,2	1,2	1,2
Inflating gun		with twin air valve	standard	standard	standard	standard
Automatic charger	Art.	52020	-	-	-	-
Packing	N° - m ³	1 - 0,088	1 - 0,088	1 - 0,088	1 - 0,090	1 - 0,090
Weight	kg	8,8	6,5	6,5	10	10
Dimensions (A - B - C)	cm	31 - 31 - 75	31 - 31 - 60	31 - 31 - 60	28 - 33 - 86	28 - 33 - 86

Note: type-approved for public use

Note: not type-approved for public use

Note: not type-approved for public use

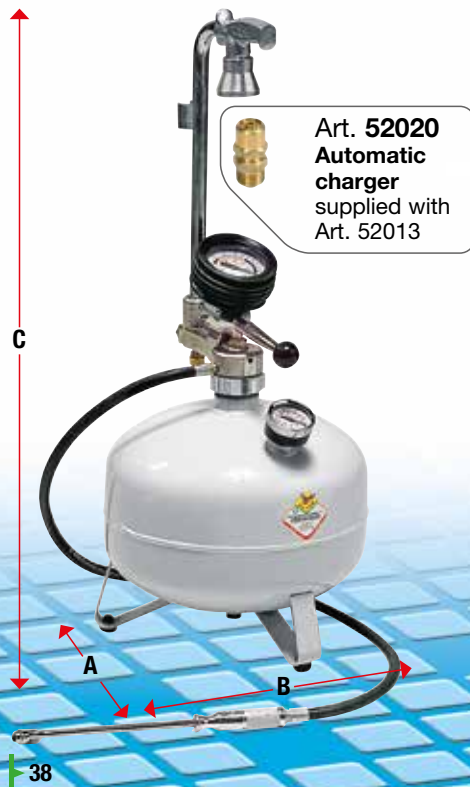

Art. 52020 Automatic charger supplied with Art. 52013

Details and advantages

The tyre inflation and deflating operations are done with single 3-position lever

- ① idle
- ② deflation
- ③ inflation

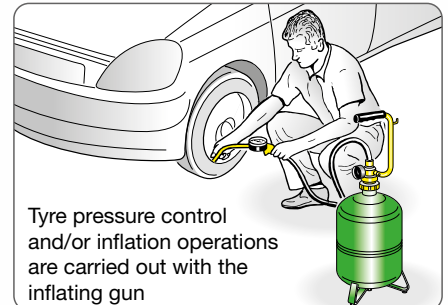
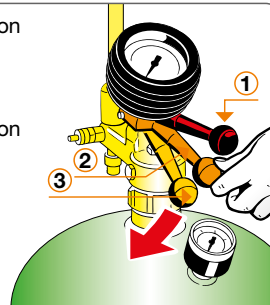

Tyre pressure control and/or inflation operations are carried out with the inflating gun

INSTALLATION MEASURES for Art. 52013

In order to have the tyre inflator always ready for use, just place it on the automatic charger as shown in the illustration

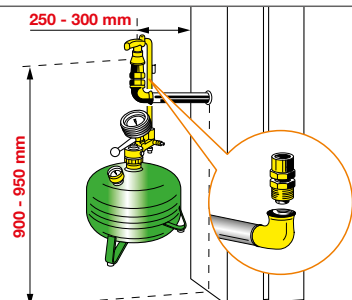



The inflator hose reel

Inflation system with hose reel for checking and restoring the pressure of any type of tyre by means of the inflation gun equipped with pressure gauge \varnothing 60 mm with scale 0 - 10 bar. Constant connection to the compressed air system makes the inflation system always ready for use. The hose reel is equipped with a system for quick hooking to the wall support to facilitate possible moving.

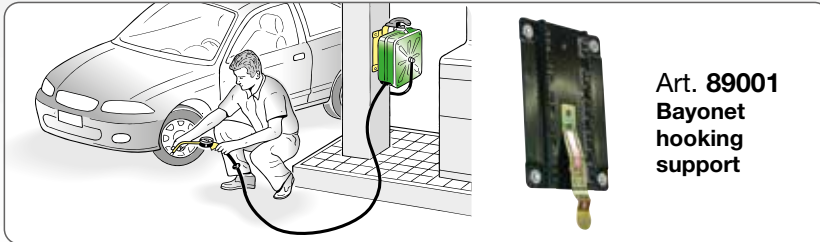

Art. 89001
Bayonet
hooking
support



Article	52010	
Length tube	m	11
Length tube connection	m	1,5
Diameter of tube	mm	8 x 12
Inlet connection thread		M 1/4" G
Max working pressure	bar	10
Manometer \varnothing 60 working pressure	bar	0 - 10
Working temperature	$^{\circ}$ C	-20° +60°
Packing	N° - m ³	1 - 0,019
Weight	kg	6,8
Dimensions (A - B - C)	cm	31 - 11,5 - 39

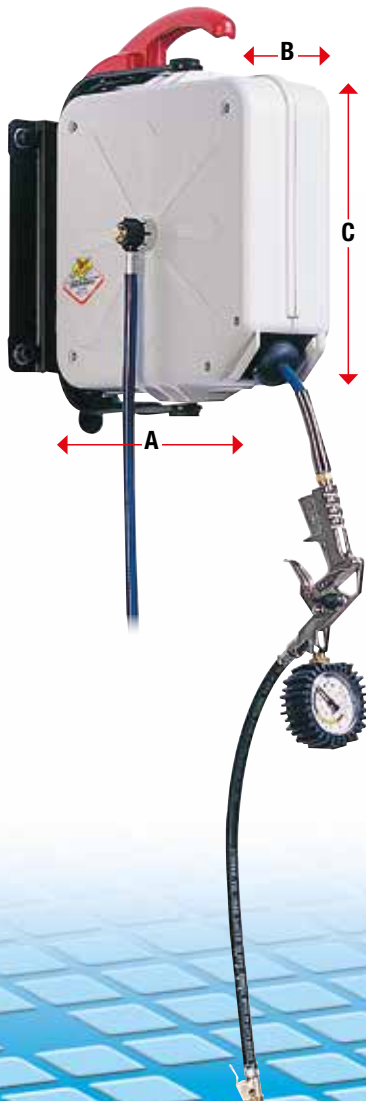

Details and advantages

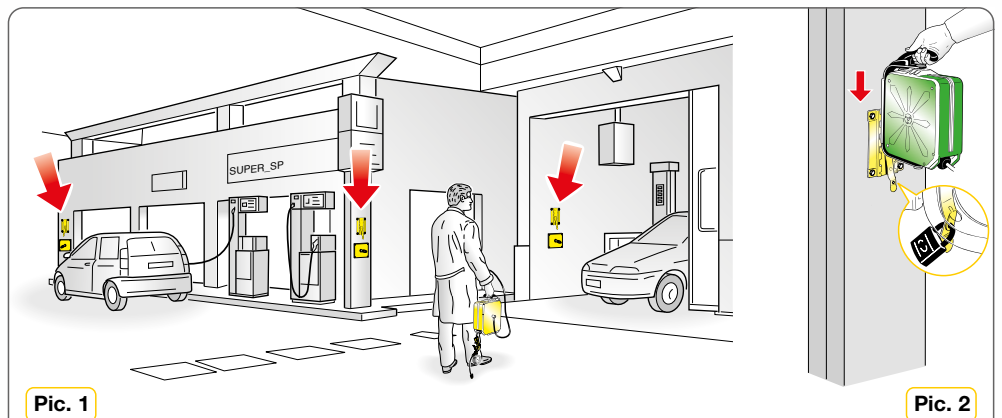

Pic. 1

Pic. 2

Pic. 1 The inflation hose reel is provided with a **wall bracket** with automatic bayonet hooking (Art. 89001) enabling **very quick and easy** installation or shifting.

The ease of this operation enables - also for safety reasons - the hose reel to be put away in a closed place at the end of the working day.

Also, the application of a wall support for every service point, either inside or outside, facilitates quick shifting and application of the hose reel in the workstation required by the operator.

Pic. 2 To prevent removal or theft of the hose reel it can be locked with a bolt or padlock.



FLUIDS AND LUBRICATION EQUIPMENT



Waste oil suction-drainers

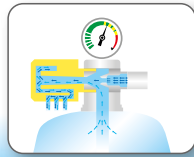

SUCTION POWER

page 42



PROBES AND ACCESSORIES

page 44



WHEEL-MOUNTED - PORTABLE SUCTION-DRAINERS

page 45



SUCTION-DRAINERS

page 46



UNIVERSAL PANTOGRAPH SUCTION-DRAINERS

page 48



GRAVITY DRAINERS

page 51



SUCTION DRAINER-DISPENSERS WITH AIR-OPERATED PUMP page 54



Suction power

To understand the concept of **suction power** it is important to remember the difference between **pressure** and **depression**.

In this way the characteristics and advantages offered by the **oil drainer** will be clearly understood.

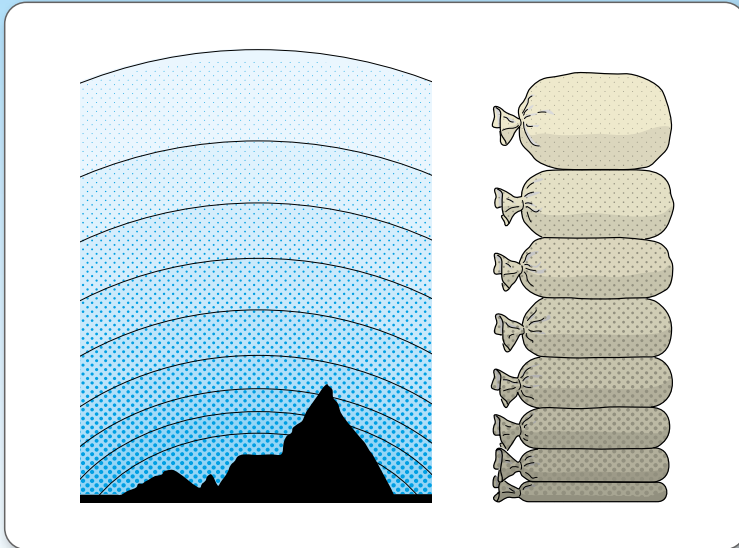

Pic. 1

Therefore, however, it is necessary to refer to the structure of the atmosphere that surrounds us and, above all, its barometric stratification and **compressibility**. Its lower layers, i.e. those nearest the ground, are more densely compressed than those higher up, precisely like what **happens with a pile of bags of compressible material**. (see Pic. 1).

The atmospheric pressure decreases as the altitude increases: at sea level it is 1 atm, at 2.000 metres a.s.l. it is approx. 0,8 atm, at 10.000 metres it falls to approx. 0,3 atm (see Pic. 2).

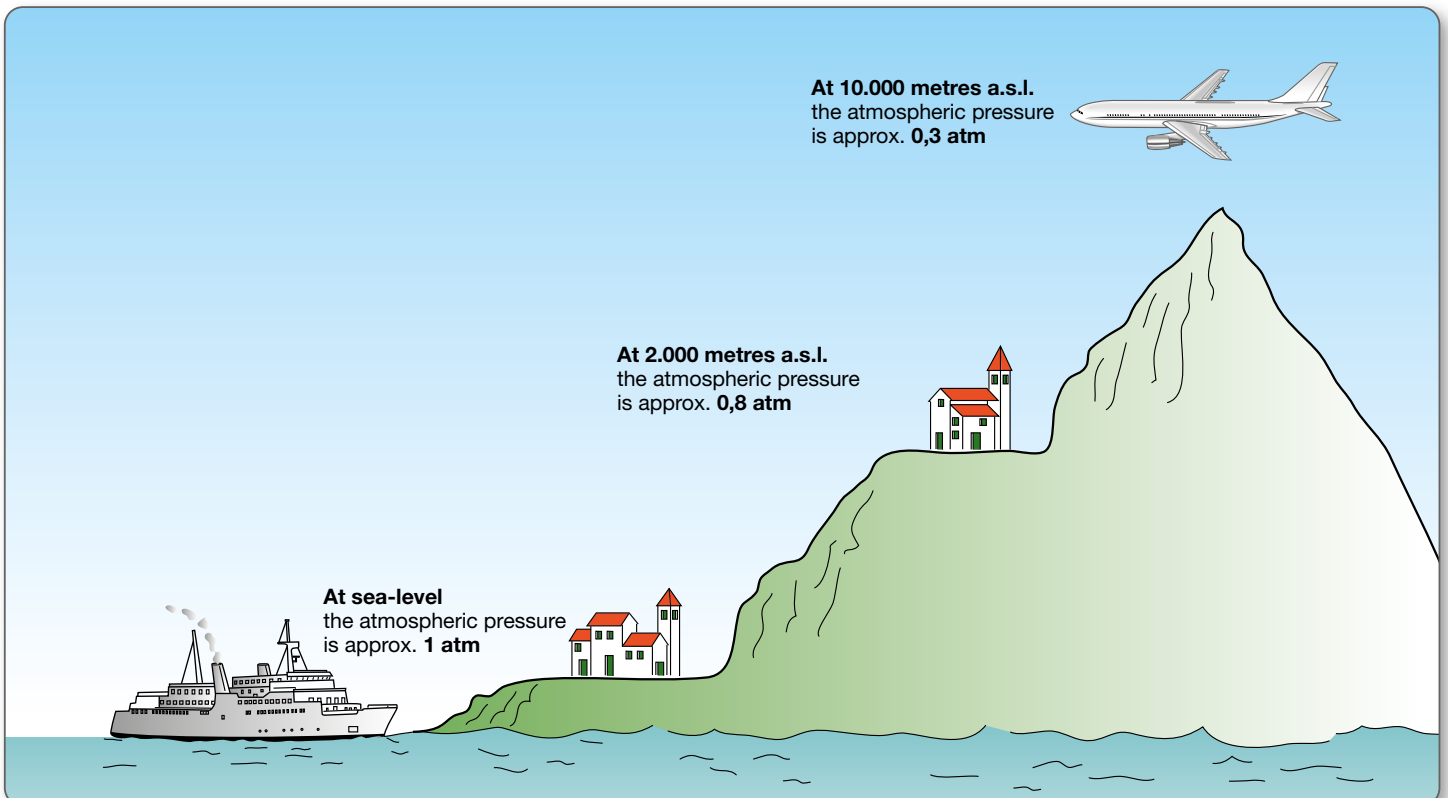

Pic. 2

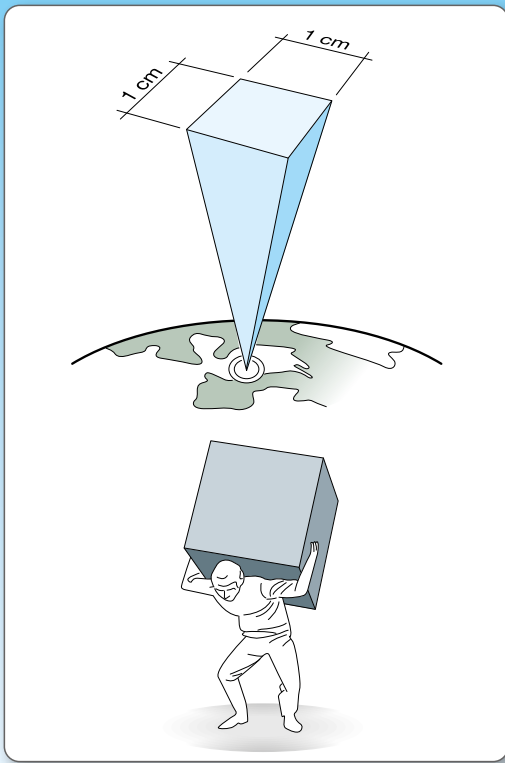

In general, pressure is obtained by compressing any type of fluid inside a given container, until reaching the required values: 1 - 3 - 10 - 100 atm without limits, apart from those of the fluid container's structure and the power of the pump used.

On the other hand, a **depression** or vacuum is obtained by removing all the air contained in a given recipient or tank, and the maximum value obtainable (vacuum or suction power) is independent of the pumping or suction system used. Whatever the pump used (**electric pump, air pump, Venturi principle, etc.**) the maximum depression (or suction power) obtained is equal to the atmospheric pressure outside the suction system.

In fact, this value cannot be exceeded because, obviously, it is not possible to remove from a container more air than what it contains.

Pump operation with Venturi principle

Connect a compressed air line (7 atm) to the special connection on the suction device. Obligated to pass through a special "MULTIPLIER NOZZLE" of the Venturi unit, the air considerably increases in speed, creating "EDDIES" that can **suck** and "pump" all the air contained in the suction device tank, thus creating a complete vacuum.

Therefore the suction force generated by the **Venturi principle** is equal to that obtained with any other air-operated and/or electric pump.

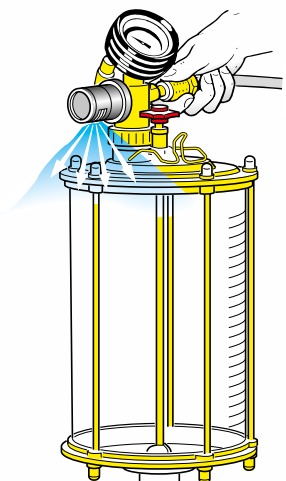
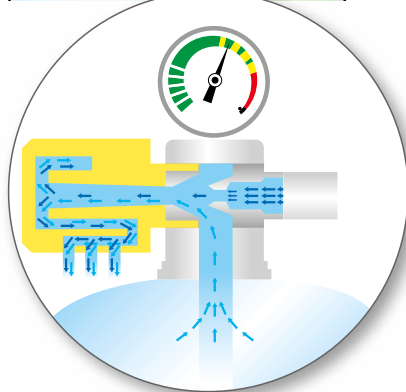

For correct depressurisation, the pressure of the air passing through the Venturi system must be between **6,5 and 7 bar**.





Flexible and metal probes - Special connections

All the drainers used for changing engine oil come with a series of standard metal and flexible probes in addition to connections for engines with incorporated probes.

Standard probe series



- Art. 45504
- Art. 45505
- Art. 45506
- Art. 45516
- Art. 45517
- Art. 45518
- Art. 45500
- Art. 45501
- Art. 45502

Art. 45560 consisting of:

- Art. 45504 flexible probe \varnothing 5 mm - length 700 mm
- Art. 45505 rigid probe \varnothing 5 mm - length 700 mm
- Art. 45506 flexible probe \varnothing 6 mm - length 700 mm
- Art. 45516 rigid probe \varnothing 6 mm - length 700 mm
- Art. 45517 flexible probe \varnothing 7 mm - length 1000 mm
- Art. 45518 flexible probe \varnothing 8 mm - length 700 mm
- Art. 45500 connection for incorporated probes Volkswagen
- Art. 45501 connection for incorporated probes BMW
- Art. 45502 connection for incorporated probes Citroen

Note: the probes can be supplied separately

Probes supplied by request



- Art. 45515
- Art. 45526
- Art. 45527
- Art. 45528
- Art. 45538
- Art. 45539
- Art. 45540

Non-standard probes available by request. Specify for vehicles requiring a longer probe for draining the oil from the bottom of the sump.

- Art. 45515 flexible probe \varnothing 5 mm - length 1000 mm
- Art. 45526 flexible probe \varnothing 6 mm - length 1500 mm
- Art. 45527 flexible probe \varnothing 7 mm - length 1500 mm
- Art. 45528 flexible probe \varnothing 7 mm - length 2000 mm
- Art. 45538 flexible probe \varnothing 8 mm - length 1500 mm for suction in trucks
- Art. 45539 flexible probe \varnothing 8 mm - length 2000 mm
- Art. 45540 special flexible probe \varnothing 12 mm - length 700 mm for quick suction.

Already supplied with the following articles:
Art. 45100 - 45110 - 45150 - 45180 - 45250 - 45280 - 43116 - 43190 - 42164 - 42215

Connectors for incorporated probes

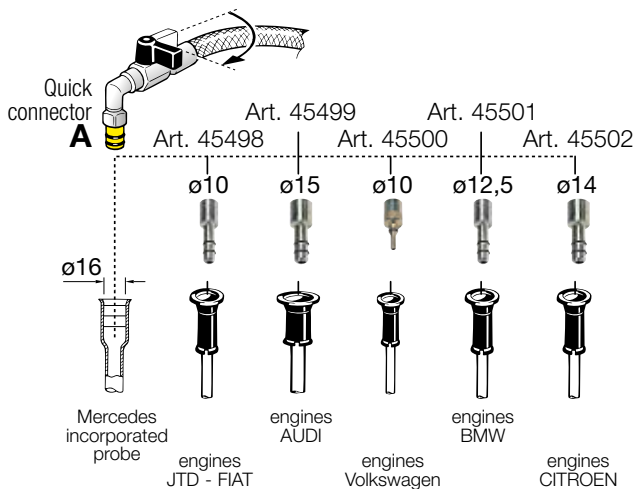

- for Mercedes cars connect the quick-release connector A of the oil drainer directly to the probe incorporated in the engine.
- for JTD Fiat Group cars: Art. 45498
- for Audi cars: Art. 45499
- for Volkswagen cars: Art. 45500
- for BMW cars: Art. 45501
- for Citroen cars: Art. 45502



Art. 45570
Wall-mounted probe kit, a handy container for the longest and less-used probes, useful for avoiding having to carry them with the drainer

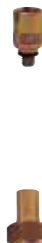
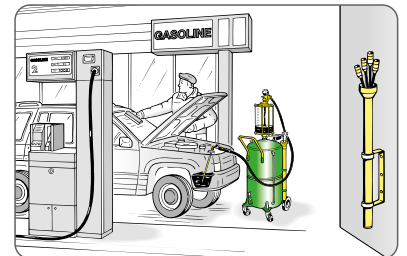

Art. 45550
3/8" connection for outboard engines supplied with the drainers for boating

Art. 45551
3/4" connection for inboard engines supplied with the drainers for boating



PORTABLE waste oil drainers

manual emptying

Air-operated drainers.

Ideal for quick engine oil change of any motor vehicle. The old oil is sucked from the engine by means of the probes supplied. After depressurisation the drainer works independently without requiring continuous connection to the compressed air system. **Suck hot oil at 70 - 80 °C.**

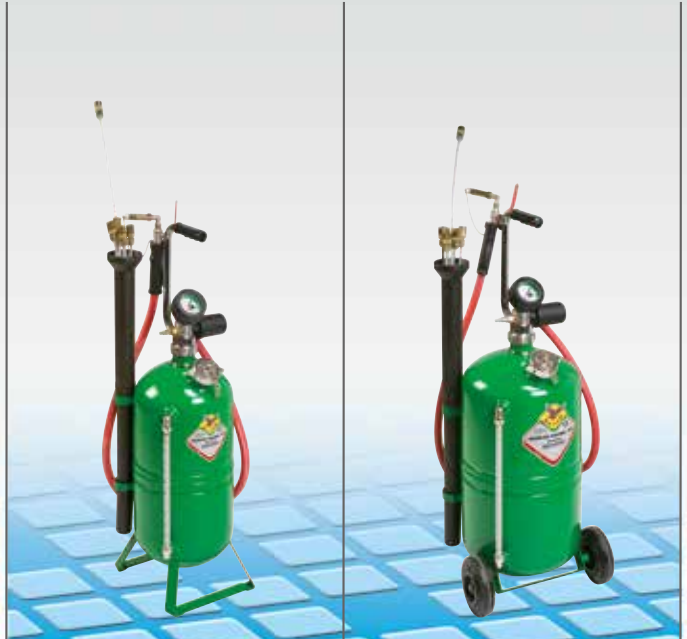
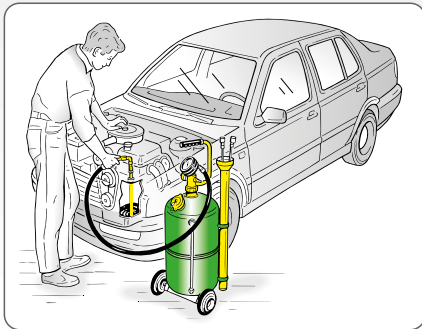

Article	portable	wheel-mounted
43016	43016	43024
Tank capacity litres	16	24
Max draining capacity litres	13	20
Air pressure for depressurisation bar	6,5 - 7	6,5 - 7
Depressurisation time min	1	1 - 1,5
Noise level dB	75	75
Suction speed l/min	1,5 - 2	1,5 - 2
Total suction capacity litres	9 - 10	15 - 16
Suction hose m	2	2
Set of probes Art.	45560	45560
Packing N° - m ³	1 - 0,080	1 - 0,090
Weight kg	10,5	13,7
Dimensions (A - B - C) cm	25,5 - 22,5 - 84,5	28 - 33 - 86

Caution: do not suck brake fluids, fuels, flammable or corrosive liquids

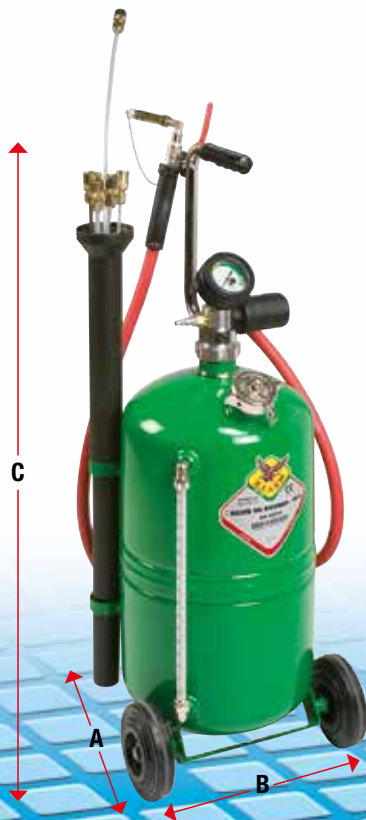

Details and advantages

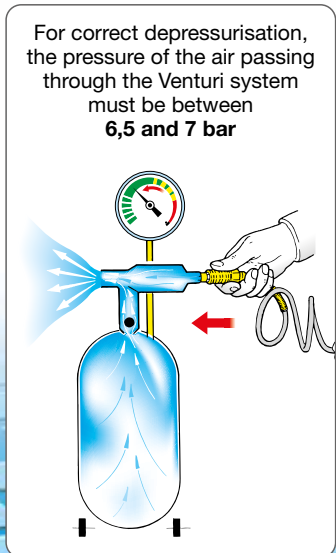
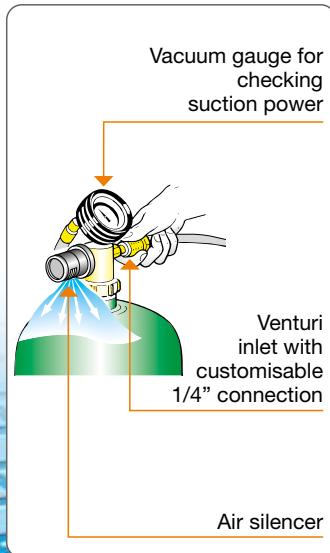



PROFESSIONAL waste oil suction-drainers

gravity-drainers

Gravity and air operated suction drainers. Ideal for quick engine oil change of any motor vehicle. Waste oil can be collected by gravity, using the bowl mounted on the adjustable support, or by suction through the supplied probes. After depressurisation the drainer works independently without requiring continuous connection to the compressed air system. **Suck hot oil at 70 - 80 °C.**

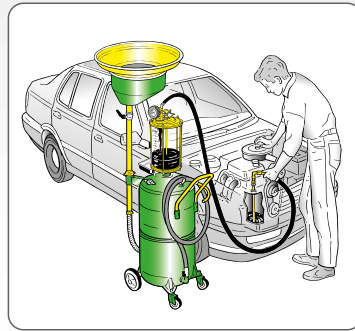
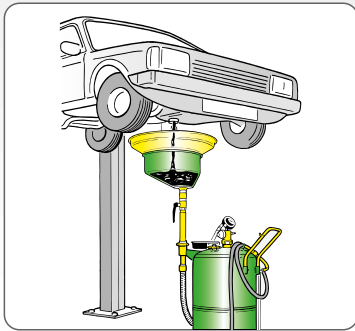

central bowl

side bowl

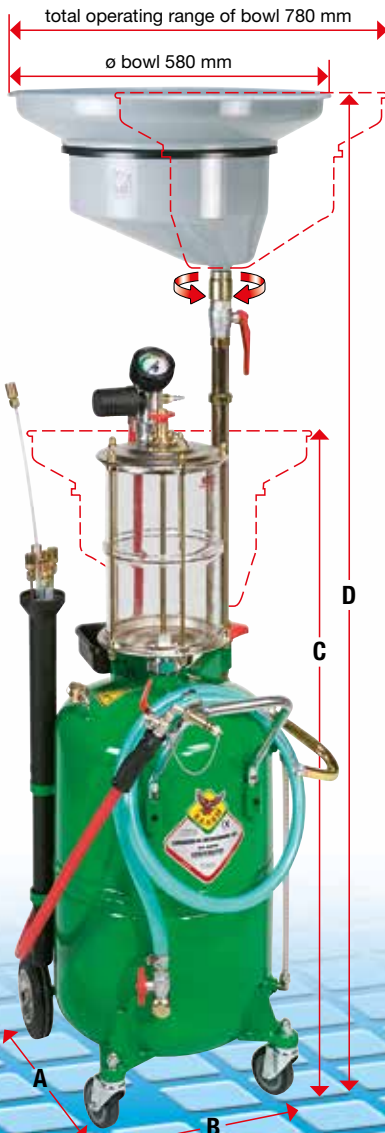

Article		42065	42090	42115	42066	42091	42116
Tank capacity	litres	65	90	115	65	90	115
Max draining capacity	litres	52	75	97	52	75	97
Prechamber capacity	litres	-	-	-	-	-	-
Bowl capacity	litres	15	15	15	15	15	15
Air pressure for depressurisation	bar	-	-	-	-	-	-
Depressurisation time	min	-	-	-	-	-	-
Noise level	dB	-	-	-	-	-	-
Suction speed	l/min	-	-	-	-	-	-
Total suction capacity	litres	-	-	-	-	-	-
Discharging/suction hose	m	draining 2	draining 2	draining 2	draining 2	draining 2	draining 2
Max pressure for draining	bar	0,5	0,5	0,5	0,5	0,5	0,5
Set of probes	Art.	-	-	-	-	-	-
Packing	N° - m ³	2 - 0,270	2 - 0,300	2 - 0,420	2 - 0,270	2 - 0,300	2 - 0,420
Weight	kg	33	34	42	33	34	42
Dimensions (A - B - C)	cm	60-42-127	64-42-140	66-49-142	60-42-134	64-42-125	66-49-128
Ingombro max (D)	cm	178	190	192	175	170	173

To connect waste oil gravity and suction drainers to emptying kit see page 50

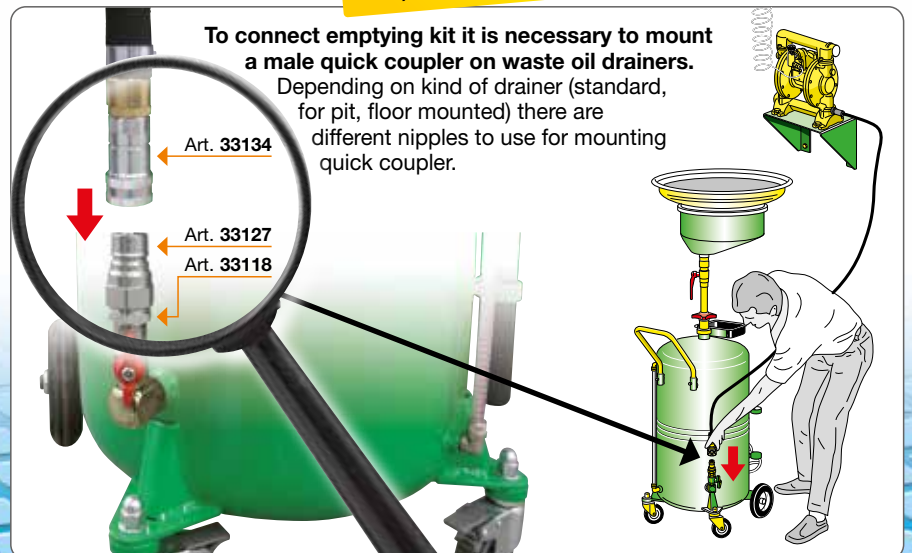

suction-drainers

combined drainers

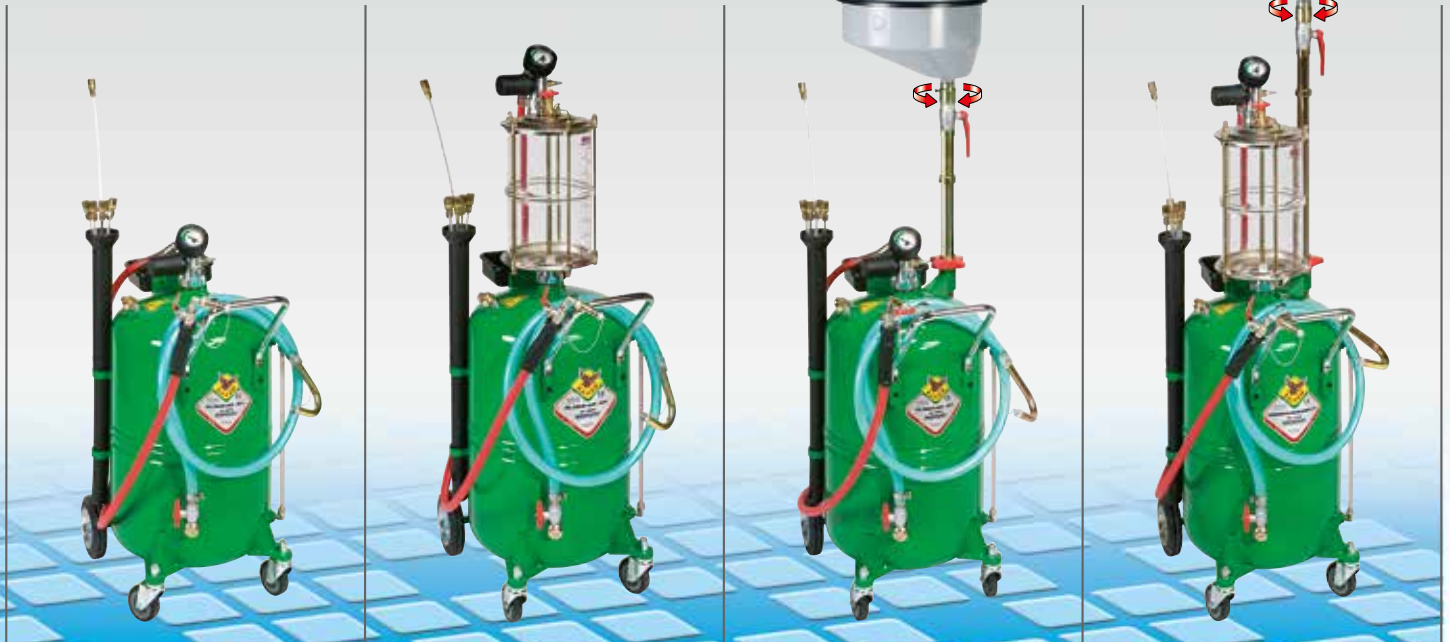

standard			with prechamber			standard			with prechamber		
43060	43090	43114	43065	43091	43115	44060	44090	44115	44065	44091	44116
65	90	115	65	90	115	65	90	115	65	90	115
52	75	97	52	75	97	52	75	97	52	75	97
-	-	-	8	8	8	-	-	-	8	8	8
-	-	-	-	-	-	15	15	15	15	15	15
6,5 - 7	6,5 - 7	6,5 - 7	6,5 - 7	6,5 - 7	6,5 - 7	6,5 - 7	6,5 - 7	6,5 - 7	6,5 - 7	6,5 - 7	6,5 - 7
2	2,5 - 3	3 - 3,5	2	2,5 - 3	3 - 3,5	2	2,5 - 3	3 - 3,5	2	2,5 - 3	3 - 3,5
75	75	75	75	75	75	75	75	75	75	75	75
1,5 - 2	1,5 - 2	1,5 - 2	1,5 - 2	1,5 - 2	1,5 - 2	1,5 - 2	1,5 - 2	1,5 - 2	1,5 - 2	1,5 - 2	1,5 - 2
43 - 45	60 - 65	85 - 90	43 - 45	60 - 65	85 - 90	43 - 45	60 - 65	85 - 90	43 - 45	60 - 65	85 - 90
2/2	2/2	2/2	2/2	2/2	2/2	2/2	2/2	2/2	2/2	2/2	2/2
0,5	0,5	0,5	0,5	0,5	0,5	0,5	0,5	0,5	0,5	0,5	0,5
45560	45560	45560	45560	45560	45560	45560	45560	45560	45560	45560	45560
2 - 0,230	2 - 0,250	2 - 0,420	2 - 0,230	2 - 0,225	2 - 0,420	3 - 0,330	3 - 0,360	3 - 0,460	3 - 0,330	3 - 0,360	3 - 0,460
26,9	31,4	42	32,9	36	43	34,6	38,2	43	38,2	42,1	50
60-42-86	64-42-100	66-49-102	60-42-128	64-42-140	66-49-142	62-42-134	62-42-138	66-49-170	60-42-153	62-42-166	66-49-168
-	-	-	-	-	-	175	188	190	175	188	190

Caution: do not suck brake fluids, fuels, flammable or corrosive liquids

Details and advantages

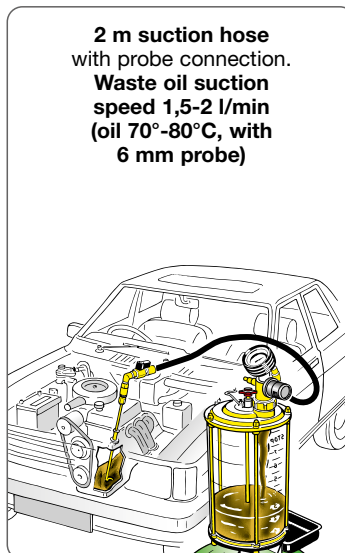
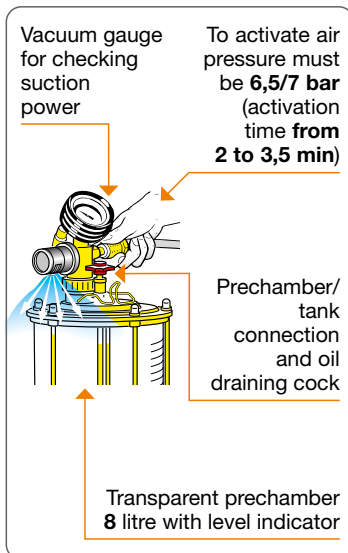
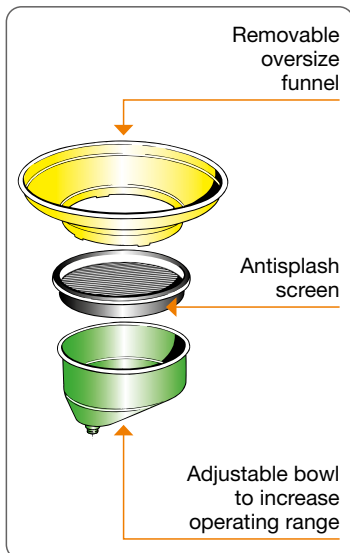



PANTOGRAPH waste oil suction-drainers

moto and cars

Air-operated combination suction-drainer (50 litre) with pantograph collection bowl and wheel-mounted 115 litre tank. Waste oil can be collected whether by gravity, using the recovering basin on the floor or in the upper position if vehicles are over car lift, or by suction through the supplied probes. After depressurisation the drainer works independently without requiring continuous connection to the compressed air system. Suck hot oil at 70 - 80 °C

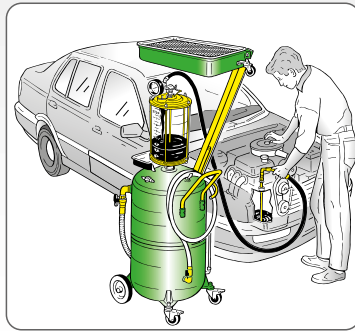
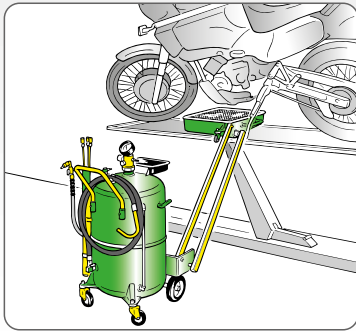

suction-drainers

combination

Article	46064	46065
Tank capacity	litres	litres
	65	65
Max draining capacity	litres	litres
	52	52
Prechamber capacity	litres	litres
	-	-
Bowl capacity	litres	litres
	14	14
Air pressure for depressurisation	bar	bar
	-	6,5 - 7
Depressurisation time	min	min
	-	2
Noise level	dB	dB
	-	75
Suction speed	l/min	l/min
	-	1,5 - 2
Total suction capacity	litres	litres
	-	43 - 45
Discharging/suction hose	m	m
	2	2/2
Max pressure for draining	bar	bar
	0,5	0,5
Set of probes	Art.	Art.
	-	45560
Packing	N° - m ³	N° - m ³
	3 - 0,247	4 - 0,310
Weight	kg	kg
	38,2	42,7
Dimensions (A - B - C)	cm	cm
	57 - 49 - 100	57 - 49 - 100
Max dimensions (D)	cm	cm
	200	200

Caution: do not suck brake fluids, fuels, flammable or corrosive liquids

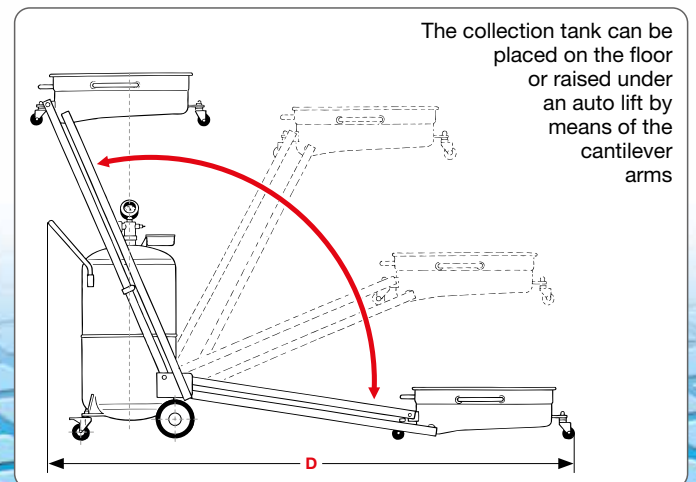

The collection tank can be placed on the floor or raised under an auto lift by means of the cantilever arms

cars

trucks



suction-drainers	combination	with prechamber	with collecting basin (50 litres)
46114	46115	46116	46215
115	115	115	115
97	97	97	97
-	-	8	-
14	14	14	50
-	6,5 - 7	6,5 - 7	6,5 - 7
-	3 - 3,5	3 - 3,5	3 - 3,5
-	75	75	75
-	1,5 - 2	1,5 - 2	1,5 - 2
-	85 - 90	85 - 90	85 - 90
2	2/2	2/2	2/2
0,5	0,5	0,5	0,5
-	45560	45560	45560
3 - 0,360	4 - 0,420	4 - 0,420	4 - 0,5
51	54	58	68
65 - 58 - 150	65 - 58 - 150	65 - 58 - 150	70 - 62 - 156
240	240	240	255

Details and advantages

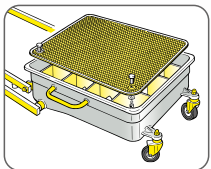

Protection screen/filter splash guard and support base for filter

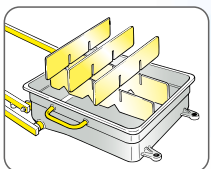

Tank with antisplash

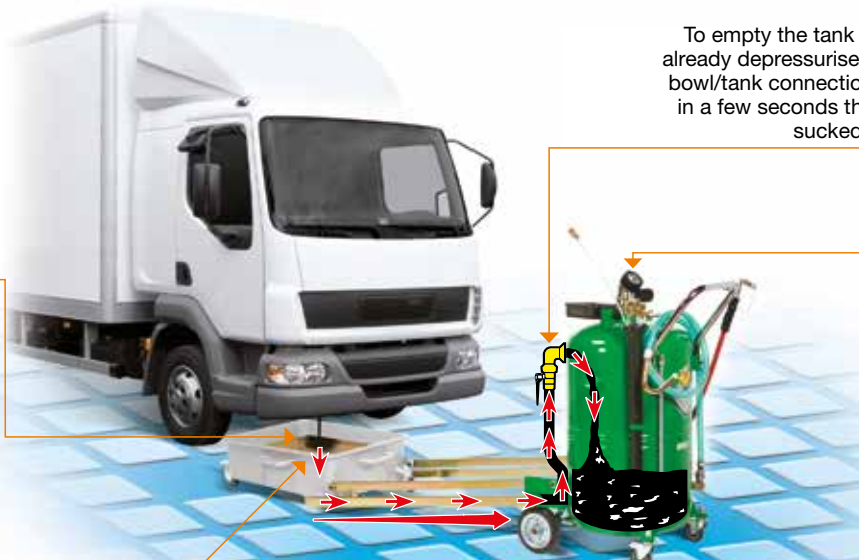

To empty the tank with device already depressurised, open the bowl/tank connection cock and in a few seconds the oil will be sucked in the tank

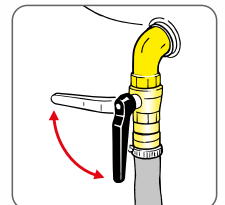

The air pressure for correct depressurisation is between **6,5 and 7 bar**



Modular kit for TRANSFER or EMPTYING

oil, waste oil and similar

Wall-mounted transfer kit. A practical solution for draining movable equipment, waste oil suction/drainers by means of connection with quick-coupling valve. Wall application enables connection to a fixed system for discharging the sucked liquid directly into the storage tank.

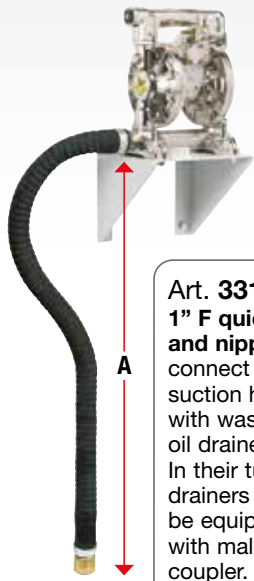

Art. 33134
1" F quick coupler and nipple to connect pump suction hose with waste oil drainers. In their turn drainers must be equipped with male quick coupler.

Aticle with seals in	Viton®		33125
Aticle with seals in	NBR	33550	
Ratio		1:1	1:1
Capacity	l/min	70	23
Pump	Art.	33/2011NHHV2	33070
Flexible suction tube 2 m	Art.	38026	38026
Air inlet flow regulator	Art.	37803	37803
Wall bracket	Art.	33590	33115
Packing	N° - m ³	1 - 0,030	1 - 0,029
Weight	kg	14	8,4
Distance (A)	cm	150	150

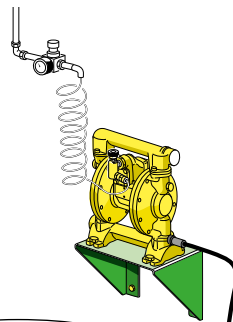

1 Pit waste oil drainer

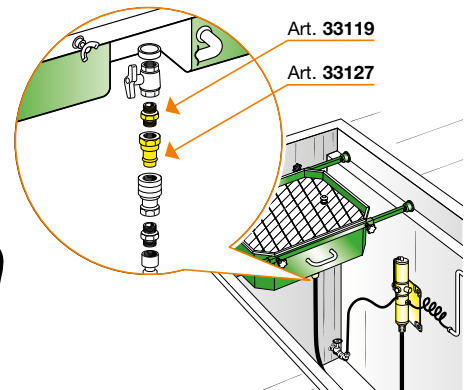

2 Floor waste oil drainer

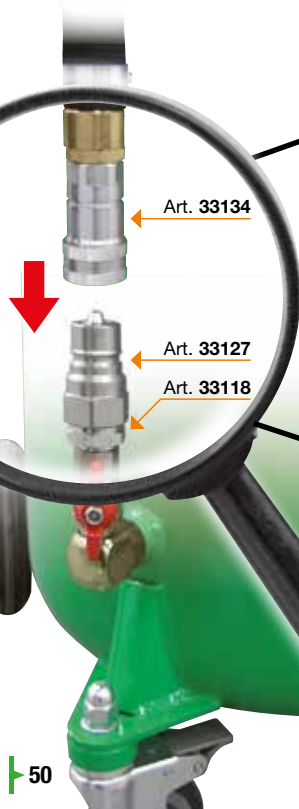
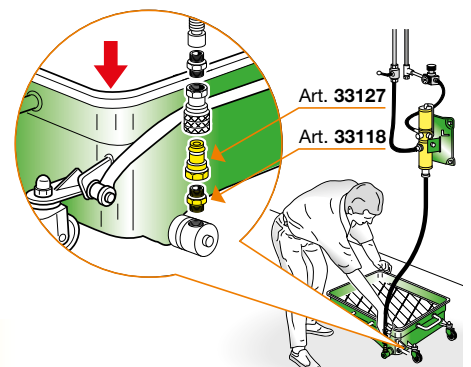

To connect waste oil drainers with above mentioned emptying kit it is necessary to mount a male quick coupler. Depending on the kind of waste oil drainers (standard, for pit or floor mounted) a different nipple must be used as shown in the examples (Pic. 1 - 2 - 3).

3 Standard waste oil drainer



Waste oil drainers for DRUM

Wheel-mounted waste oil drainers. Ideal for use with jerry cans, drums and containers of various sizes, up to 220 kg. Suitable for gravity draining of engine, gearbox and differential oil from all motor vehicles placed on an car lift or pit.

The height-adjustable **bowl** (15 litres) is mounted on a swivel joint that facilitates positioning.

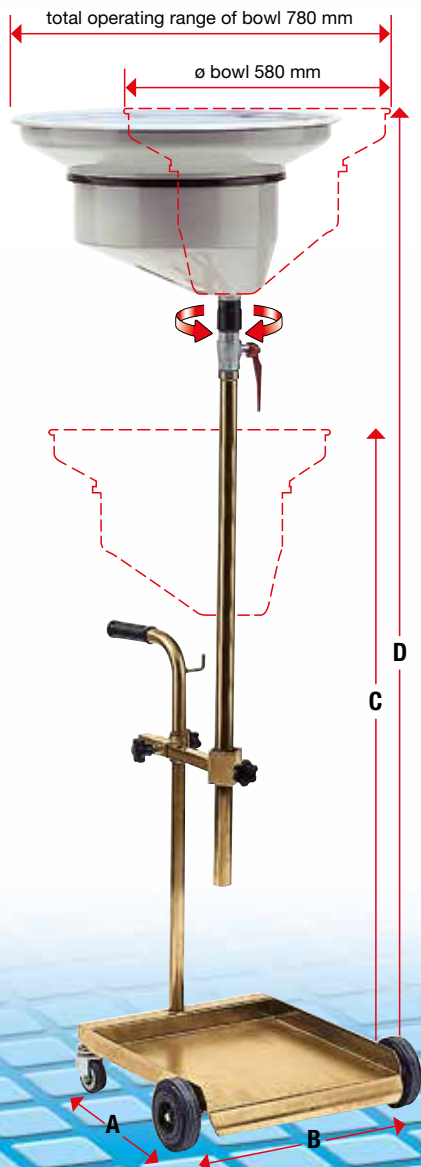
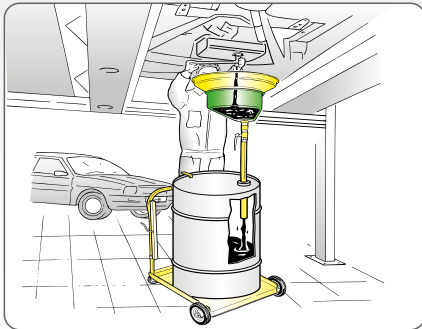

		adjustable bowl	wheel-mounted	wheel-mounted
Article		42004	42050	42000
Trolley capacity	litres	-	20 - 60	180 - 220
trolley	Art.	-	80050	80200
Bowl capacity	litres	15	15	15
Antisplash screen		yes	yes	yes
Drum clamping ring		yes	yes	yes
Packing	N° - m ³	1 - 0,350	2 - 0,120	2 - 0,150
Weight	kg	9	17	29
Dimensions (A - B - C)	cm	58 - 58 - 115	64 - 50 - 120	70 - 77 - 130
Max dimensions (D)	cm	115	180	180

Caution: do not use with flammable or corrosive liquids

Details and advantages

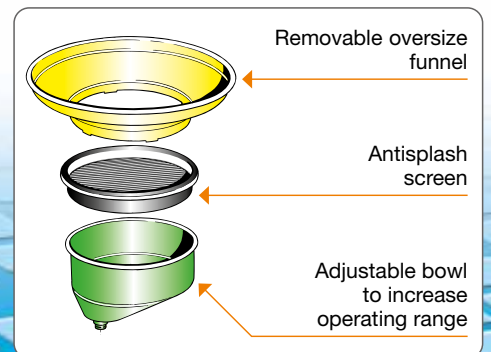
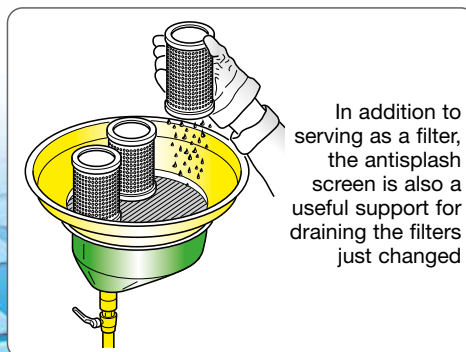
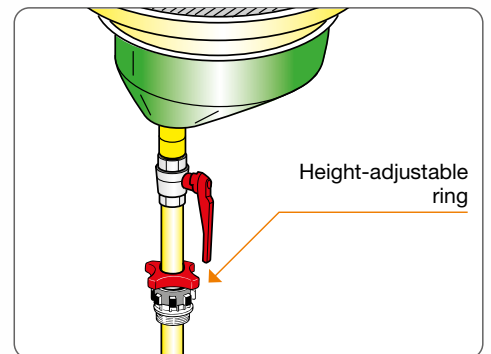
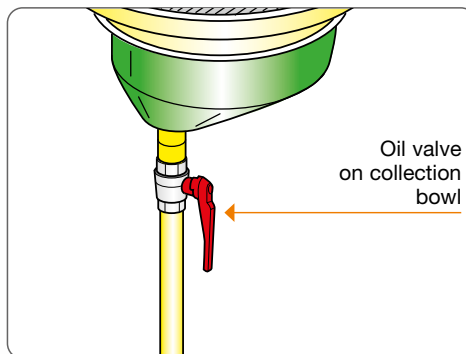



Waste oil pit drainer

Pit waste oil drainers.

Suitable for gravity draining of engine, gearbox and differential oil from all motor vehicles placed on a pit. Equipped with antisplash screen which can be used as a support for draining oil filters.

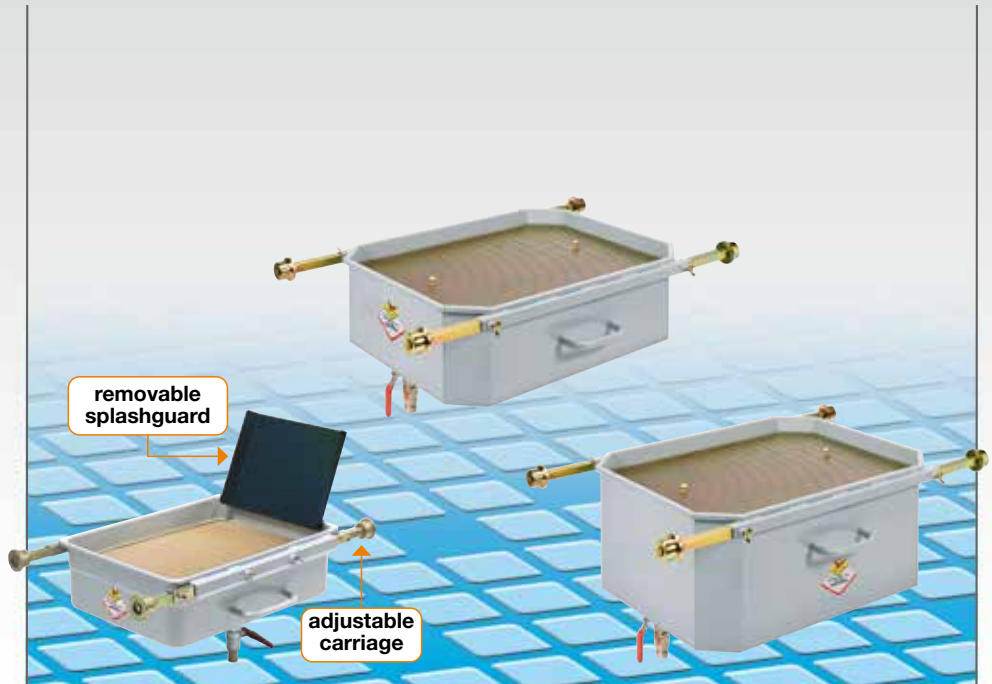
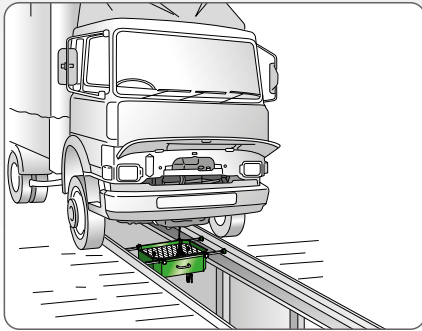

Article	42059	42060	42061	42062	42055	42056
Tank capacity litres	65	65	110	110	150	150
Wheels	adjustable carriage	adjustable carriage	adjustable carriage	adjustable carriage	adjustable carriage	adjustable carriage
Emptying	by suction	by gravity	by suction	by gravity	by suction	by gravity
Equipped with	quick-release connector	hose-holder ø 30	quick-release connector	hose-holder ø 30	quick-release connector	hose-holder ø 30
Packing N° - m ³	1 - 0,140	1 - 0,140	1 - 0,220	1 - 0,220	1 - 0,270	1 - 0,270
Weight kg	27,5	28	39,5	40	53,5	54
Dimensions (A - B - C) cm	51 - 66 - 22	51 - 66 - 22	63,5 - 79 - 26,4	63,5 - 79 - 26,4	63,5 - 79 - 35,7	63,5 - 79 - 35,7
Dimensions (D - E) cm	75 - 120	75 - 120	84 - 125	84 - 125	84 - 125	84 - 125

Caution: do not use with flammable or corrosive liquids

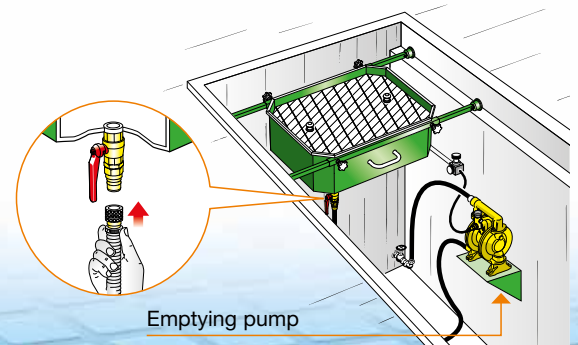
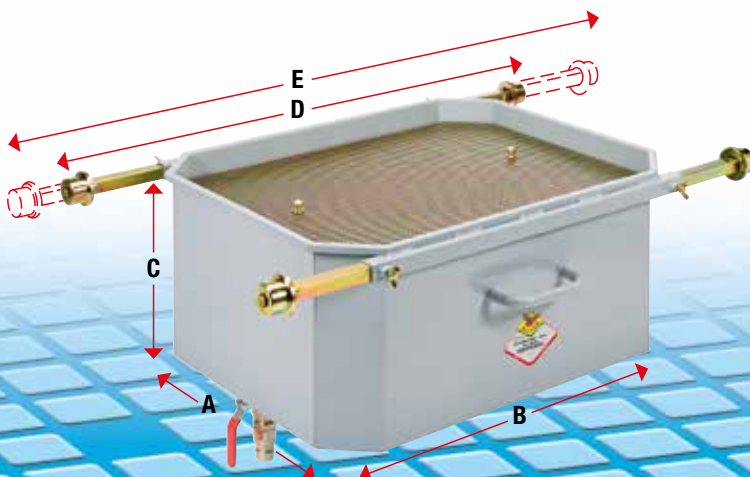
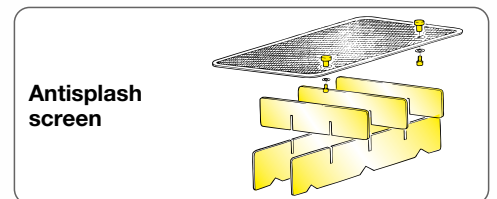

The drained oil can be transferred from the collection bowl to the storage tank by gravity or by using an emptying pump connected to the fixed system



Waste oil floor drainer

Wheel-mounted floor waste oil drainers. Suitable for gravity draining of engine, gearbox and differential oil from all motor vehicles. Equipped with antisplash screen which can be used as a support for draining oil filters.

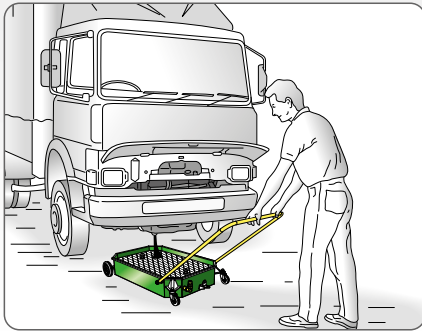

Article	42069	42070	42072	42073	42075	42076
Tank capacity	litres	50	50	95	95	150
Wheels	4 castors	4 castors	2 castors + 2 fixed	2 castors + 2 fixed	2 castors + 2 fixed	2 castors + 2 fixed
Emptying	by suction	by suction	by suction	pneumatic	by suction	pneumatic
Equipped with	quick-release connector	junction tube	quick-release connector	33070	quick-release connector	33/2011NHHV2
Packing	N° - m ³	1 - 0,140	1 - 0,140	1 - 0,200	1 - 0,200	1 - 0,330
Weight	kg	20,5	21	37,5	40	53
Dimensions (A - B - C)	cm	63 - 66 - 23,5	63 - 66 - 23,5	72,5 - 99 - 20	72,5 - 99 - 20	74,2 - 99,6 - 29,5
Dimensions (D - E)	cm	78	78	119,9	119,9	123,8

Caution: do not use with flammable or corrosive liquids

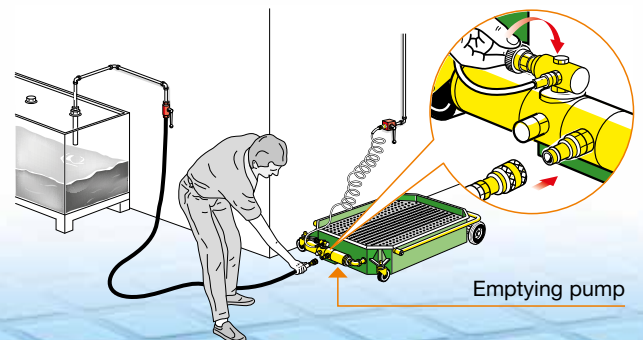
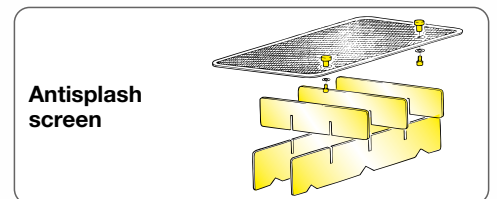

The drained oil can be transferred from the collection bowl to the storage tank by suction with the incorporated probe or by an emptying pump connected to the fixed system or mounted directly on the collection basin



Suction drainer with pump

wheel-mounted

oil, waste oil, antifreeze liquid and similar products

Air pump operated fixed drainers.

They enable **draining** by means of the probes supplied. The air pump, equipped with special Viton® seals, is particularly suitable for sucking and delivering fluids such as: various oils, old oil, antifreeze liquid, diesel oil and similar products.

Wall-mounting enables connection to a fixed system for draining the sucked liquid directly in the storage tank.

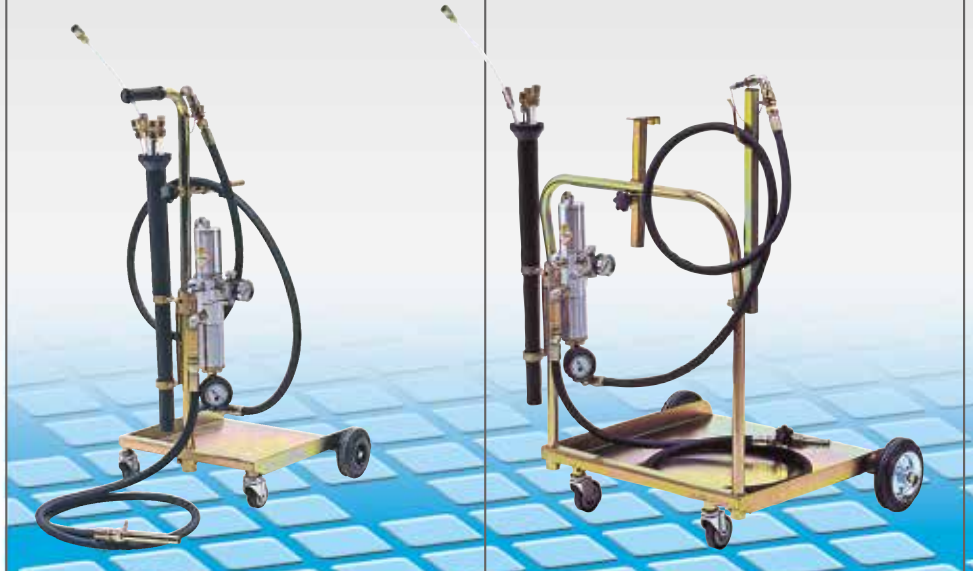
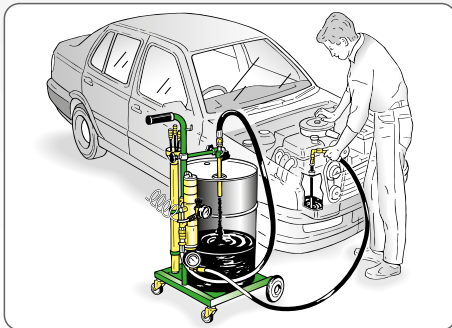

for drums **30 - 60 kg**

for drums **180 - 220 kg**

Article		45150	45180
Pump	Art.	33070/A	33070/A
Max air pressure	bar	6	6
Noise level	dB	81	81
Suitable for drums	kg	30 - 60	180 - 220
Length of suction hose	m	1/2" x 2	1/2" x 2
Length of draining hose	m	1/2" x 2	1/2" x 2
Suction speed	l/min	1,5 - 2	1,5 - 2
Trolley	Art.	80050	80200
Column	Art.	-	-
Wall bracket	Art.	-	-
Wall-mounted probe kit	Art.	-	-
Hose reels	Art.	-	-
Set of probes	Art.	45560	45560
Special probe	Art.	45540 ø 12	45540 ø 12
Packing	N° - m ³	2 - 0,080	2 - 0,113
Weight	kg	19,5	32,1
Dimensions (A - B - C)	cm	100 - 50 - 64	87 - 76 - 67

Caution: do not suck any flammable or corrosive liquids

Overall dimensions

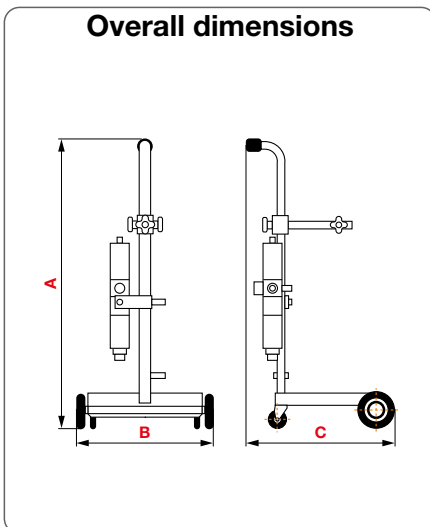

Details and advantages

For correct draining, the pump must operate slowly.

To adjust the working speed, operate the flow regulator, "metering" the inlet air feed. Make sure the vacuum gauge indicator is always in the optimum position

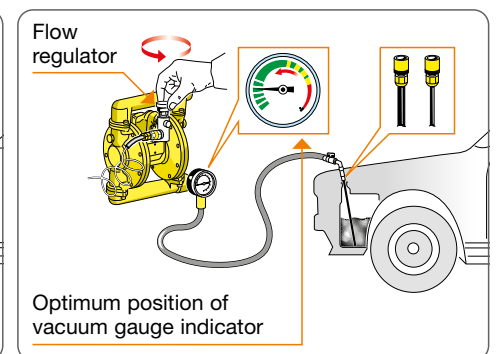
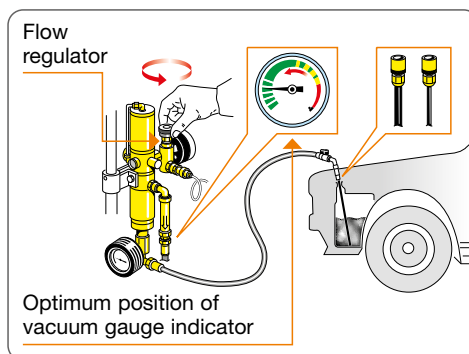

wall-mounted



wall-mounted - suction hose 4 m		wall-mounted - suction hose 10 m		column-mounted - suction hose 10 m	
45100	45300	45110	45310	45111	45311
33070/A	33/2011NHHV2	33070/A	33/2011NHHV2	33070/A	33/2011NHHV2
6	6	6	6	6	6
81	75	81	75	81	75
wall-mounted	wall-mounted	wall-mounted	wall-mounted	wall-mounted	wall-mounted
1/2" x 4	1/2" x 4	1/2" x 10	1/2" x 10	1/2" x 10	1/2" x 10
1/2" x 4	1/2" x 4	1/2" x 4	1/2" x 4	1/2" x 4	1/2" x 4
1,5 - 2	1,5 - 2	1,5 - 2	1,5 - 2	1,5 - 2	1,5 - 2
-	-	-	-	-	-
-	-	-	-	39320	39320
33115	33590	33115	33590	33115	33590
45570	45570	45570	45570	45570	45570
-	-	8430.401/AS	8430.401/AS	8430.401/AS	8430.401/AS
45560	45560	45560	45560	45560	45560
45540 ø 12	45540 ø 12	45540 ø 12	45540 ø 12	45540 ø 12	45540 ø 12
1 - 0,056	2 - 0,070	2 - 0,116	3 - 0,130	3 - 0,250	4 - 0,260
12,2	14	29,1	31	75	77
130 - 60 - 220	130 - 60 - 220	130 - 60 - 220	130 - 60 - 220	245 - 29 - 59	245 - 29 - 59

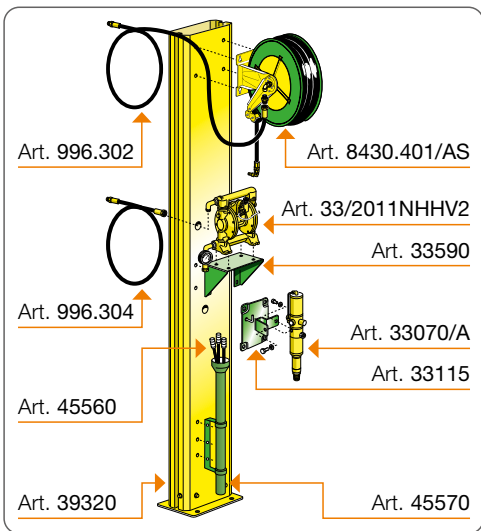
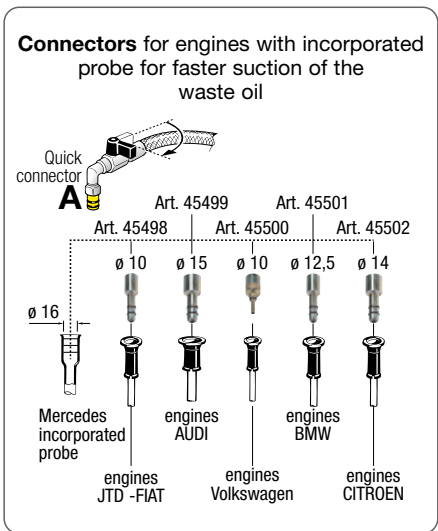
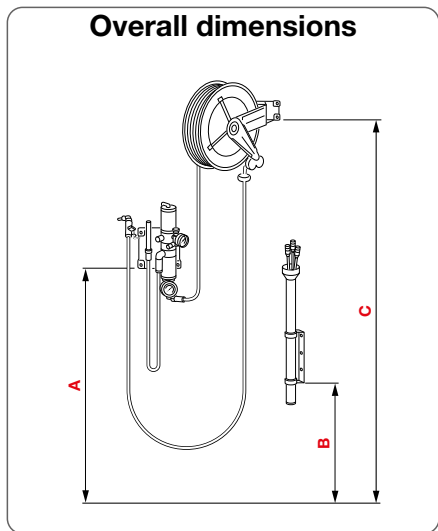



Suction drainer-dispensers for fuels



Wheel-mounted air-operated suction systems, for the management of fuels.

The air pump, equipped with special Viton® seals, is suitable for **sucking petrol or diesel oil** from any vehicle or motorcycle by means of the probes or connections supplied. The wheel-mounted drainer with pump is easy to handle, versatile. The system is equipped with an earth connection for discharging electrostatic current.



wall-mounted

wheel mounted for drums 30 - 60 kg

wheel mounted for drums 180 - 220 kg

Article		45200	45250	45280
Pump suction	Art.	-	33070/A	33070/A
Max pressure air to pump	bar	4	4	4
Noise level	dB	81	81	81
Suitable for drums	kg	-	30 - 60	180 - 220
Length of suction hose	m	-	2	2
Length of draining hose	m	-	2	2
Suction speed	l/min	5 - 10	5 - 10	5 - 10
Trolley	Art.	-	80050	80200
Wall bracket	Art.	33115	-	-
Set of probes	Art.	-	probe ø 8 - probe ø 12	probe ø 8 - probe ø 12
Connections for tubes ø 6 - 8 - 10	Art.	-	45290 - 45291 - 45292	45290 - 45291 - 45292
Earth connection 3 m		yes	yes	yes
Packing	N° - m³	1 - 0,015	2 - 0,080	2 - 0,113
Weight	kg	6,2	19,5	32,1
Dimensions (A - B - C)	cm	13,6 - 6,5 - 36	50 - 50 - 100	76 - 67 - 87

Details and advantages

For correct draining, the pump must operate slowly.

To adjust the working speed, operate the flow regulator, "metering" the inlet air feed. Make sure the vacuum gauge indicator is always in the optimum position

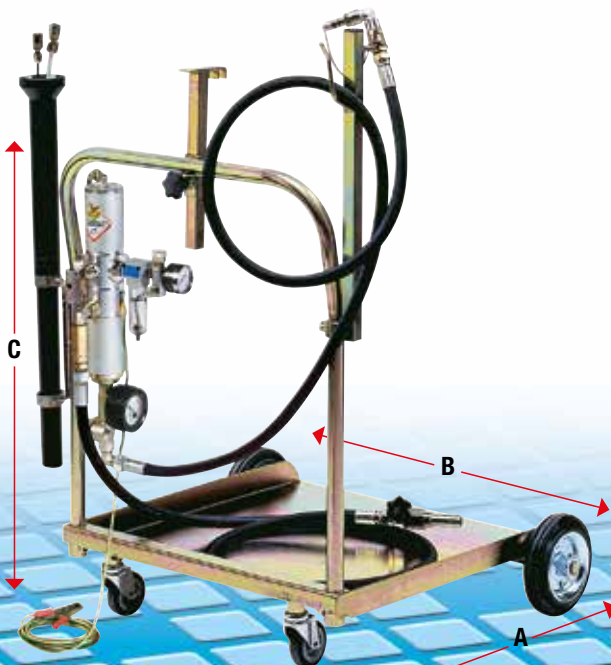
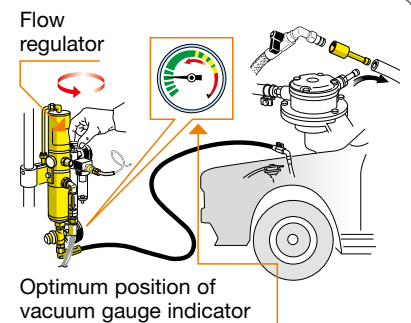

Art. 45290
Connection for
tube ø 6



Art. 45291
Connection for
tube ø 8



Art. 45292
Connection for
tube ø 10



Dual use

Draining phase

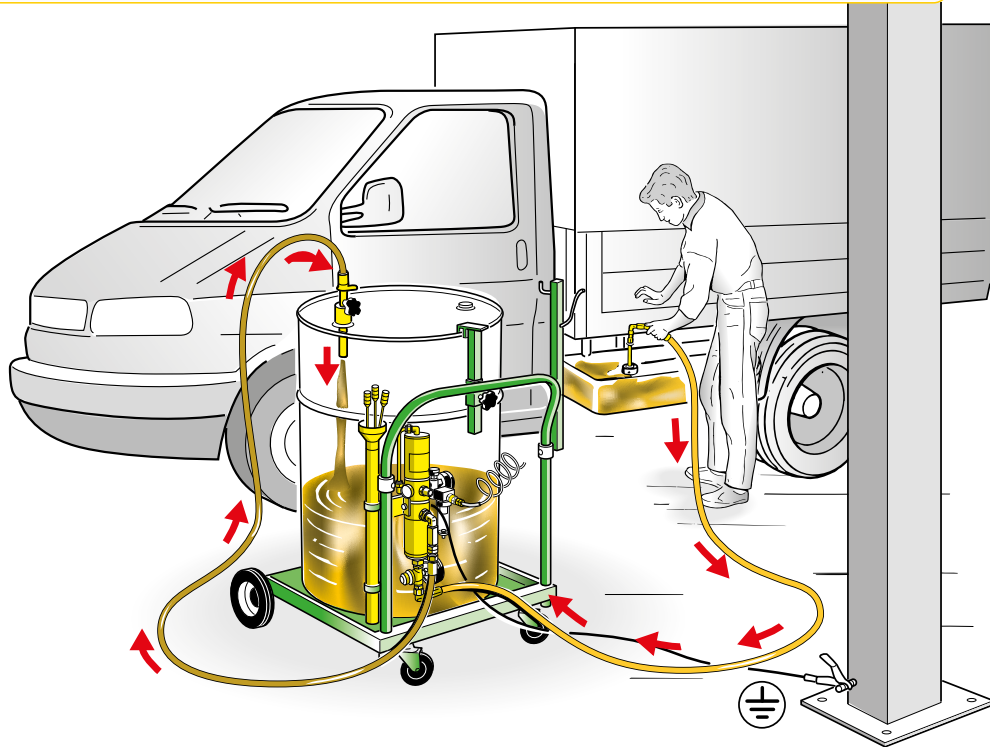

Draining occurs by means of one of the probes supplied. For fuels use the \varnothing 12 mm flexible probe.
Note: connect to earth before use

Delivery phase of previously sucked liquid

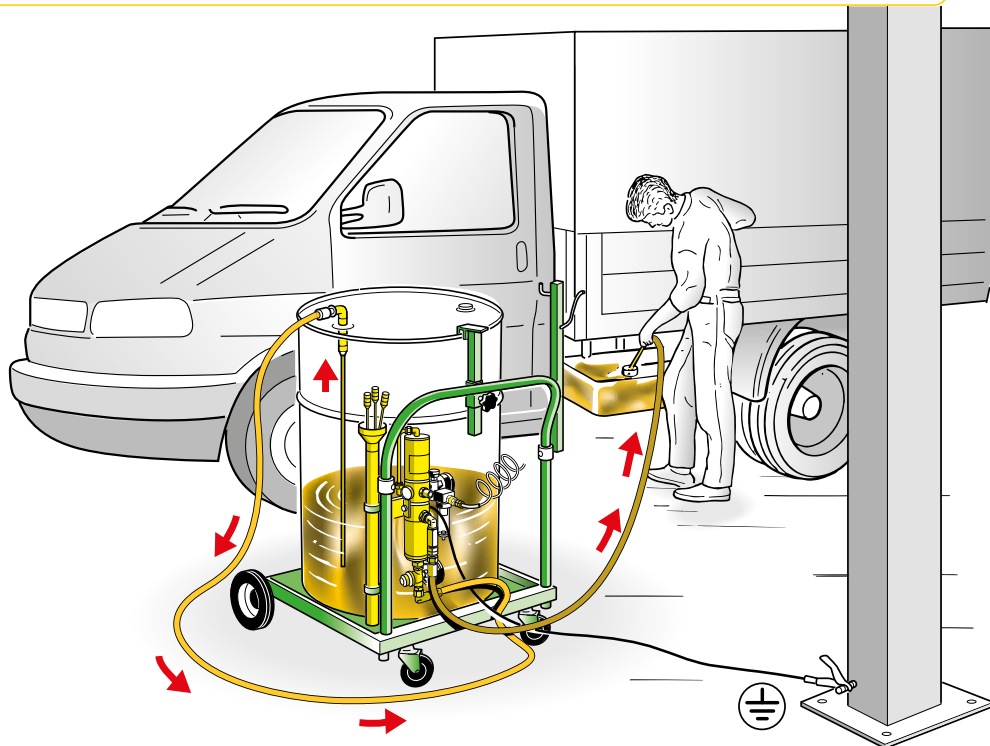

Delivery of sucked liquids occurs by reversing the position of the tubes. Insert the suction tube in the container of previously sucked liquid. Insert the draining tube in the container (or tank) just emptied.
Note: connect to earth before use



FLUIDS AND LUBRICATION EQUIPMENT



Manual pumps for oil and grease



MANUAL OIL PUMPS

page 60



AIR-OPERATED OIL DISPENSERS

page 62



13 KG MANUAL GREASE PUMPS

page 63



HAND-OPERATED HIGH PRESSURE GREASE PUMPS

page 64

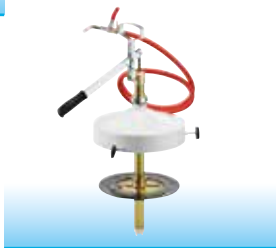

HAND-OPERATED GREASE TRANSFER PUMPS

page 65



Manual pumps oil and similar

single-
acting

double-
acting

Manual pump for oil and allied products. Single-acting and Viton® seals. Double-acting and NBR seals. The telescopic suction tube enables direct application on containers of different capacities. Suitable for delivering low-viscosity oil.

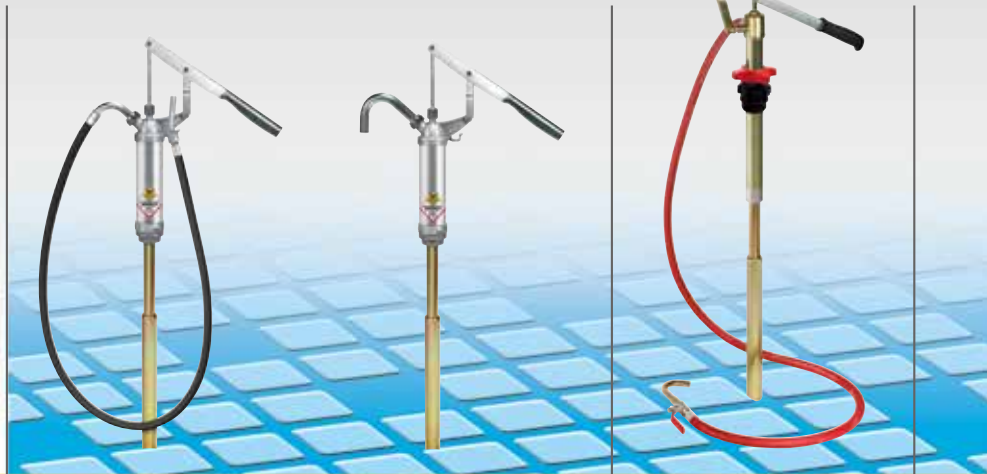

Article with seals in	Viton®	31200	31201	
Article with seals in	NBR			30200
Tank capacity	litres	-	-	-
Suitable for drums	kg	50 - 220	50 - 220	50 - 220
Delivery hose length	m	2	-	2
Suction tube length	m	0,7 - 1,04	0,7 - 1,04	0,7 - 1,04
Quantity delivered for complete cycle of the lever	g	240	240	220
Max oil density delivered	SAE	130	130	240
Drum clamping ring	Art.	-	-	38044
Trolley	Art.	-	-	-
Antisplash funnel	Art.	-	-	-
Packing	N° - m ³	1 - 0,016	1 - 0,016	1 - 0,016
Weight	kg	4,2	4,0	4,4
Dimensions (A - B - C)	cm	5,7 - 5,7 - 138	5,7 - 5,7 - 138	3,8 - 3,8 - 115

Caution: do not use with flammable or corrosive liquids



Art. 24891

Antisplash funnel

With antisplash rim to prevent the liquid from spilling out when filling the tank

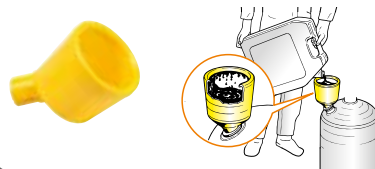

Art. 32713

Digital litre-counter complete with connection unions
- not type-approved for public use

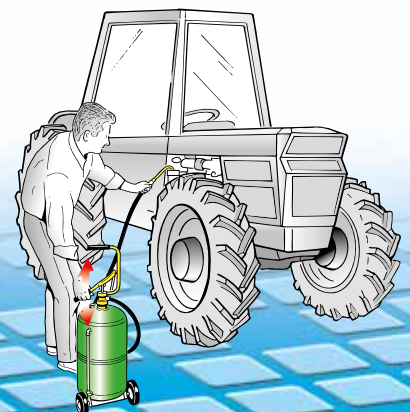
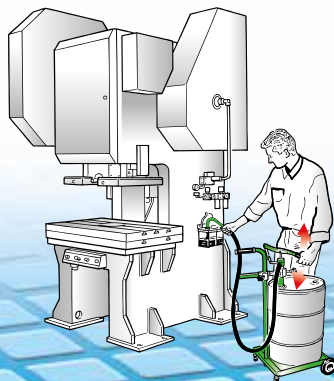
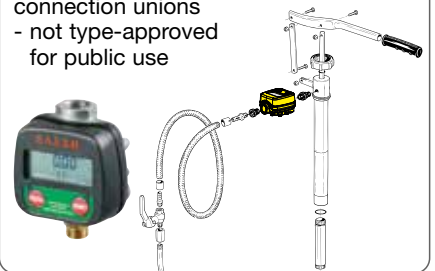

double-acting

double-acting pump



30050

32016

32024

32065

-

16

24

65

30 - 60

-

-

-

2

2

2

2

0,7 - 1,04

-

-

-

220

220

220

220

240

240

240

240

38044

-

-

-

80050

-

-

-

-

24891

24891

24891

2 - 0,040

1 - 0,080

1 - 0,090

1 - 0,185

13,6

10,6

13,7

24

46 - 50 - 123

25,5 - 22,5 - 86

28 - 33 - 89

60 - 42 - 88

Single-action (Pic. 1) occurs when the pumping piston delivers the fluid only in the pumping lever downstroke

Pic. 1



Double-action (Pic. 2) occurs when the pumping piston delivers the fluid in its upstroke and downstroke. Double-action delivers the fluid with a continuous and constant flow

Pic. 2

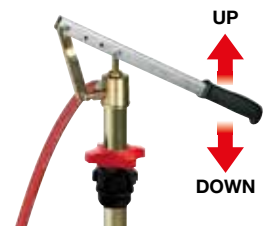

Lever hooking variation table

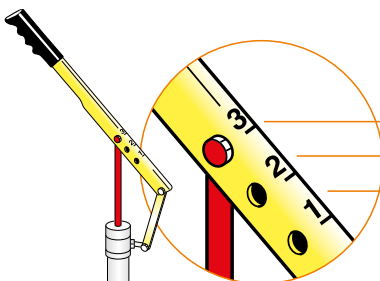

Hooking position	Pumping shaft stroke	Compression ratio obtainable	Delivery capacity with complete cycle	Indication of types of oil that can be delivered according to the lever position
n°3	127 mm	1 : 2,2	220 g	SAE W 80/90
n°2	100 mm	1 : 3,6	170 g	SAE W 85/140
n°1	60 mm	1 : 6,9	100 g	SAE 240

The position of lever pivot can be varied (3 hookings) to adapt the pumping force to the viscosity of the oil used



Air-operated oil dispensers



portable

wheel-mounted

Air-operated oil dispensers

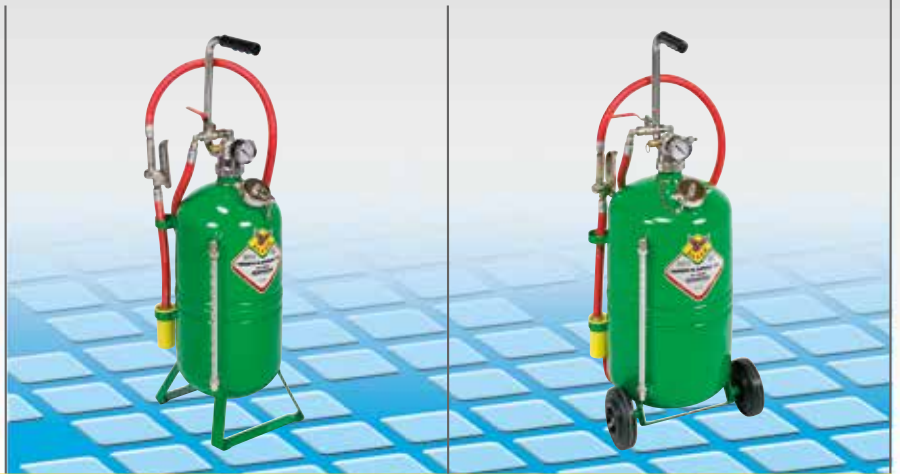
suitable for high-viscosity oil.
Filled with oil to 4/5 their capacity
and pressurised to 6 - 8 bar,
they work independently without
requiring connection to the
compressed air system.
The air-operated oil dispensers are
ideal for filling or topping-up engine,
gearbox, differential, hydraulic power
pack, reduction unit oil, etc.



Article		33016	33024
Tank capacity	litres	16	24
Working pressure	bar	6 - 8	6 - 8
Safety valve	bar	10	8
Delivery hose length	m	2	2
Gun hose length	m	0,27	0,27
Max oil density delivered	SAE	130	130
Antisplash funnel	Art.	24891	24891
Packing 	N° - m ³	1 - 0,080	1 - 0,090
Weight 	kg	9,9	13,1
Dimensions (A - B - C)	cm	25,5 - 22,5 - 86	28 - 33 - 89

Caution: do not use with flammable or corrosive liquids

Art. 24891

Antisplash funnel.

With antisplash rim to prevent the liquid from spilling out when filling the tank

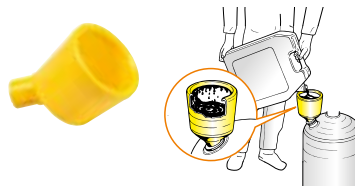

Art. 32713

Digital litre-counter kit with partial and cumulative reading, complete with connection unions.
Application between the pump and delivery hose allows the quantity of oil delivered to be controlled
- not type-approved for public use

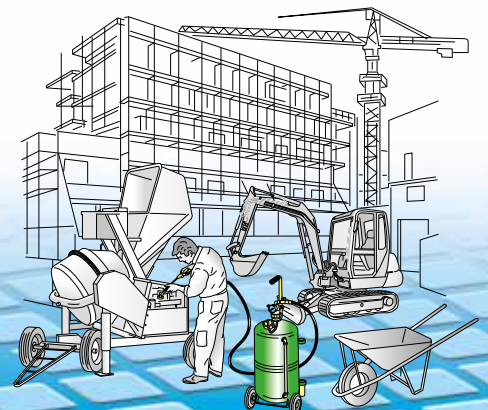



Portable grease dispenser

Portable and wheel-mounted or air operated manual grease pumps. Practical and functional, they can be used in all workplaces and enable quick, high-pressure greasing on any motor vehicle or mechanism. They are equipped with a grease follower plate that protects the lubricant and ensures positive priming.

manual

air operated



Article		68012	68113	68213
Tank capacity	kg	13	13	13
Delivery hose length	m	2,5 - 1/4"	2,5 - 1/4"	4 - 1/4"
Delivery hose	Art.	KR6802	KR6802	993.504
Max outlet pressure	bar	350/400	300/350	350/400
Capacity every 10 cycles of lever Pump	g	60	40	-
Compression ratio	Art.	-	-	62041
Noise level	dB	-	-	50:1
Max working pressure	bar	-	-	81
Max air consumption	l/min	-	-	8
Capacity (free outlet 6 bar self-levelling grease at 20° C)	g/min	-	-	330
Grease follower plate	Art.	yes	yes	yes
Grease coupler	Art.	66739	66739	66740
Nipple	Art.	-	-	66892
Grease gun	Art.	-	-	66888
Packing	N° - m ³	1 - 0,070	1 - 0,070	1 - 0,100
Weight	kg	10,4	14	16,7
Dimensions (A - B - C)	cm	34 - 24,5 - 71	52 - 34 - 84	30 - 34 - 84



Details and advantages

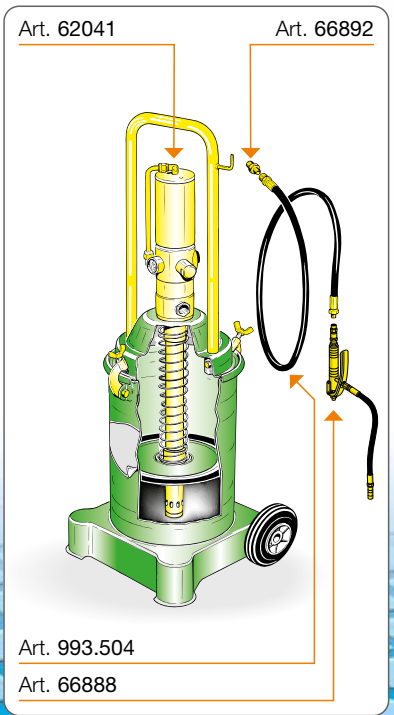
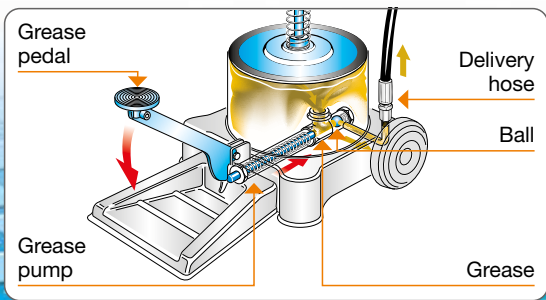
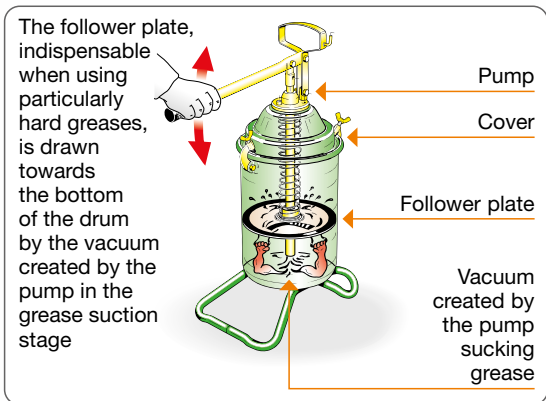



Manual grease pumps

high pressure **350 bar**

Portable lever-operated manual grease pumps. Practical and functional, they can be used in all workplaces, and in particular on rough ground such as in farming or building sites. They enable easy change of the grease container (drum or bucket) and quick greasing on any motor vehicle or mechanism. They are equipped with a grease follower plate that protects the lubricant and ensures positive priming.

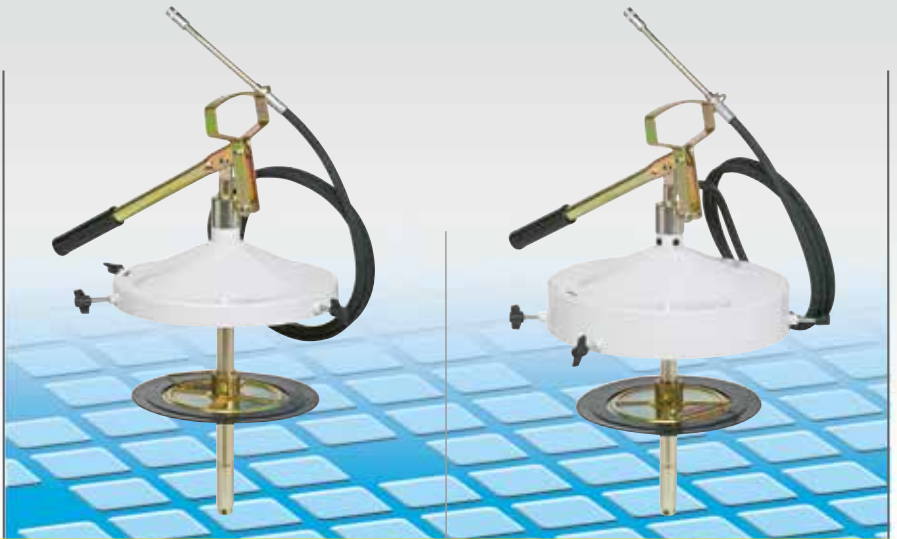

Article		60280	60310	60311
Suitable for drums	kg	12 - 20	16 - 30	16 - 30
		from 240 to 280	from 260 to 300	from 270 to 330
For drums with external ø	mm			
Delivery hose length	m	2,5 - 1/4"	2,5 - 1/4"	2,5 - 1/4"
Max outlet pressure	bar	350/400	350/400	350/400
Capacity every 10 cycles of lever	g	60	60	60
Drum cover ø	mm	280	310	337
Grease follower plate ø	mm	265	310	310
Grease coupler	Art.	66739	66739	66739
Packing	N° - m ³	1 - 0,022	1 - 0,022	1 - 0,036
Weight	kg	5,4	6,5	7,2
Dimensions (A - B - C)	cm	63 - 28 - 35	63 - 31 - 35	63 - 33,7 - 35

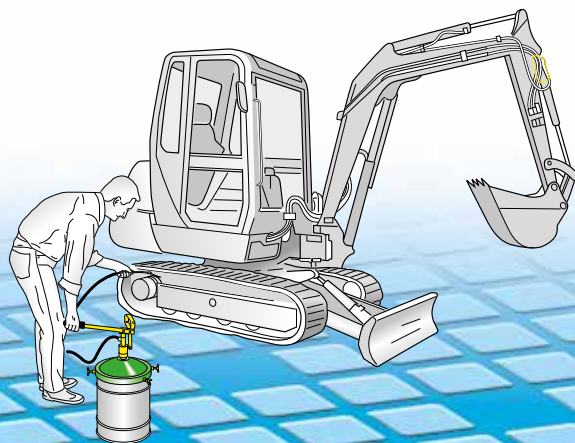
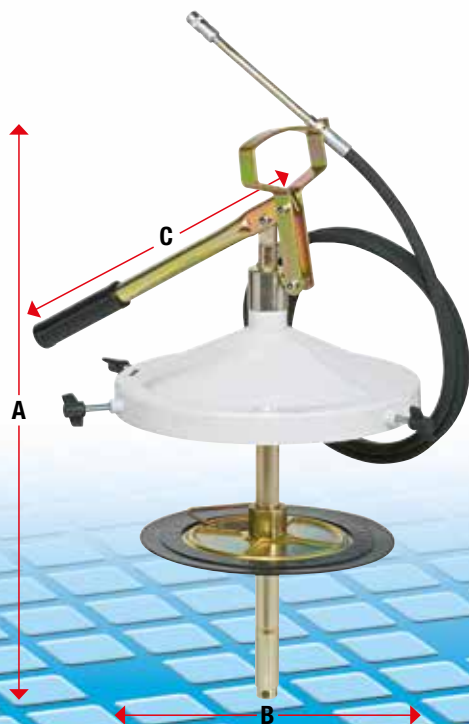
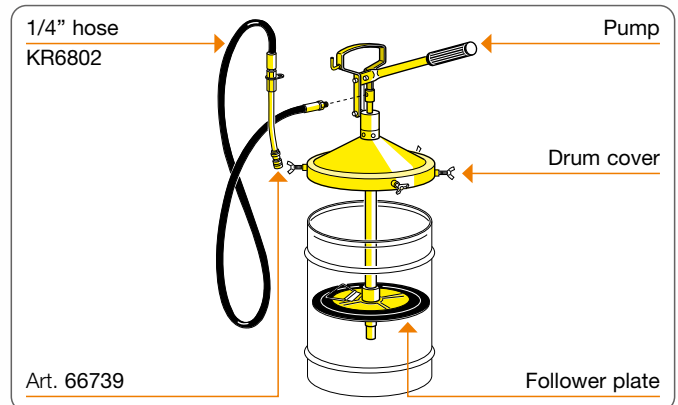





Manual grease pumps

low pressure transferring **20 bar**

Portable manual lever-operated grease transfer pumps.

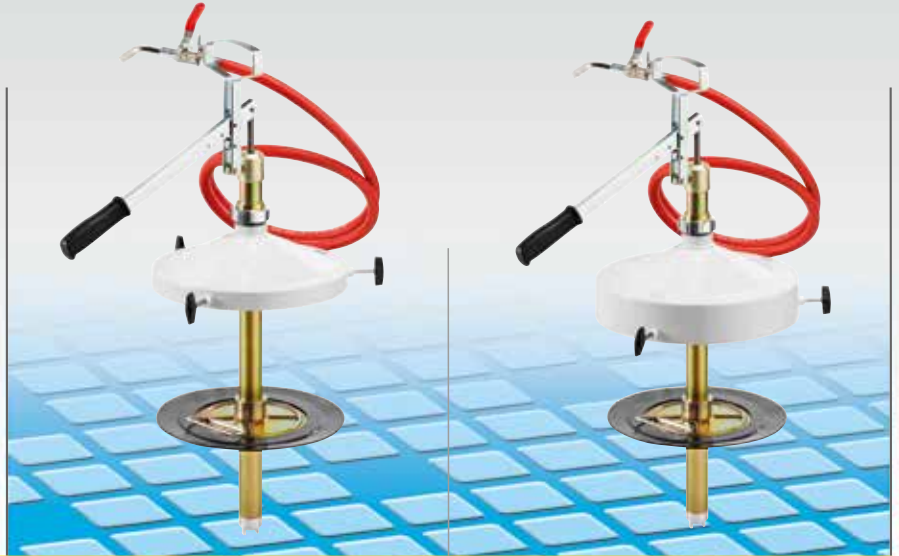
Each cycle of the lever delivers 50 g of grease. Practical and handy, they are used for filling gearcases, casings, hand-operated grease guns. They enable easy changing of the grease container (drums or bucket) and are equipped with a grease follower plate that protects the lubricant and ensures positive priming.



Article		60410	60411
Suitable for drums	kg	16 - 30	16 - 30
		from 260 to 300	from 270 to 330
For drums with external ø	mm		
Delivery hose length	m	2 - 1/2"	2 - 1/2"
Max outlet pressure	bar	18/20	18/20
Capacity every 10 cycles of lever	g	500	500
Drum cover ø	mm	310	337
Grease follower plate ø	mm	310	310
Packing	N° - m ³	1 - 0,030	1 - 0,040
Weight	kg	6	6,7
Dimensions (A - B - C)	cm	78 - 31 - 35	78 - 33,7 - 35

Art. 60450

Female quick connector
complete with check valve,
1/4" F thread for filling central
greasing system.
Max pressure 350 bar



Art. 60451

Male quick connector
complete with check valve,
1/4" F thread for filling central
greasing system.
Max pressure 350 bar



Quick connect coupling

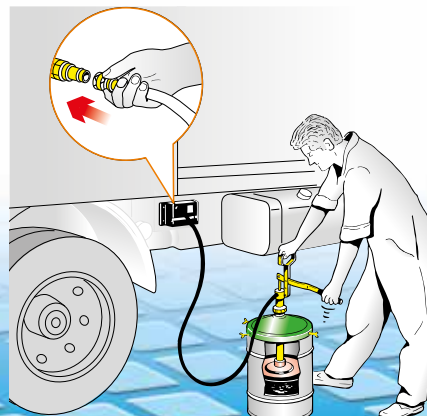
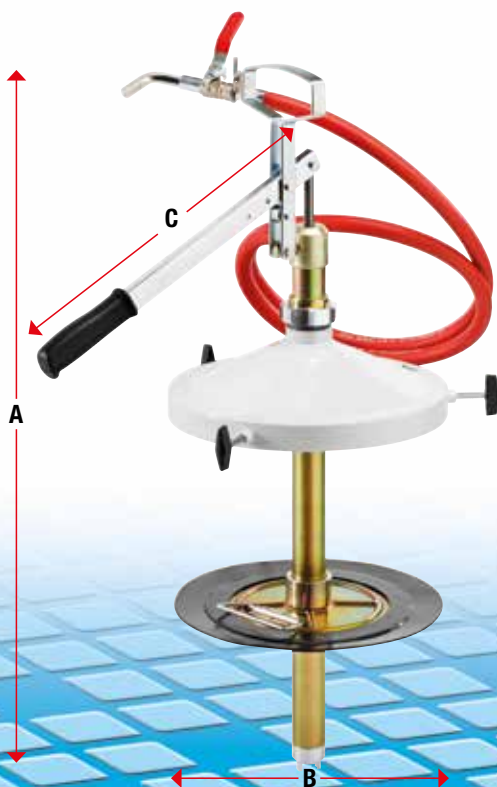
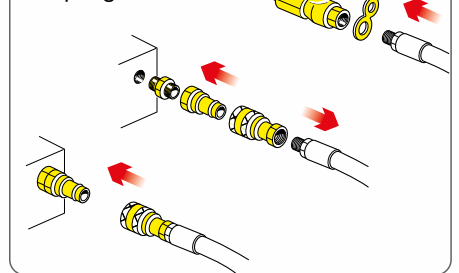

Filling central greasing system



Transfer in small drums



FLUIDS AND LUBRICATION EQUIPMENT

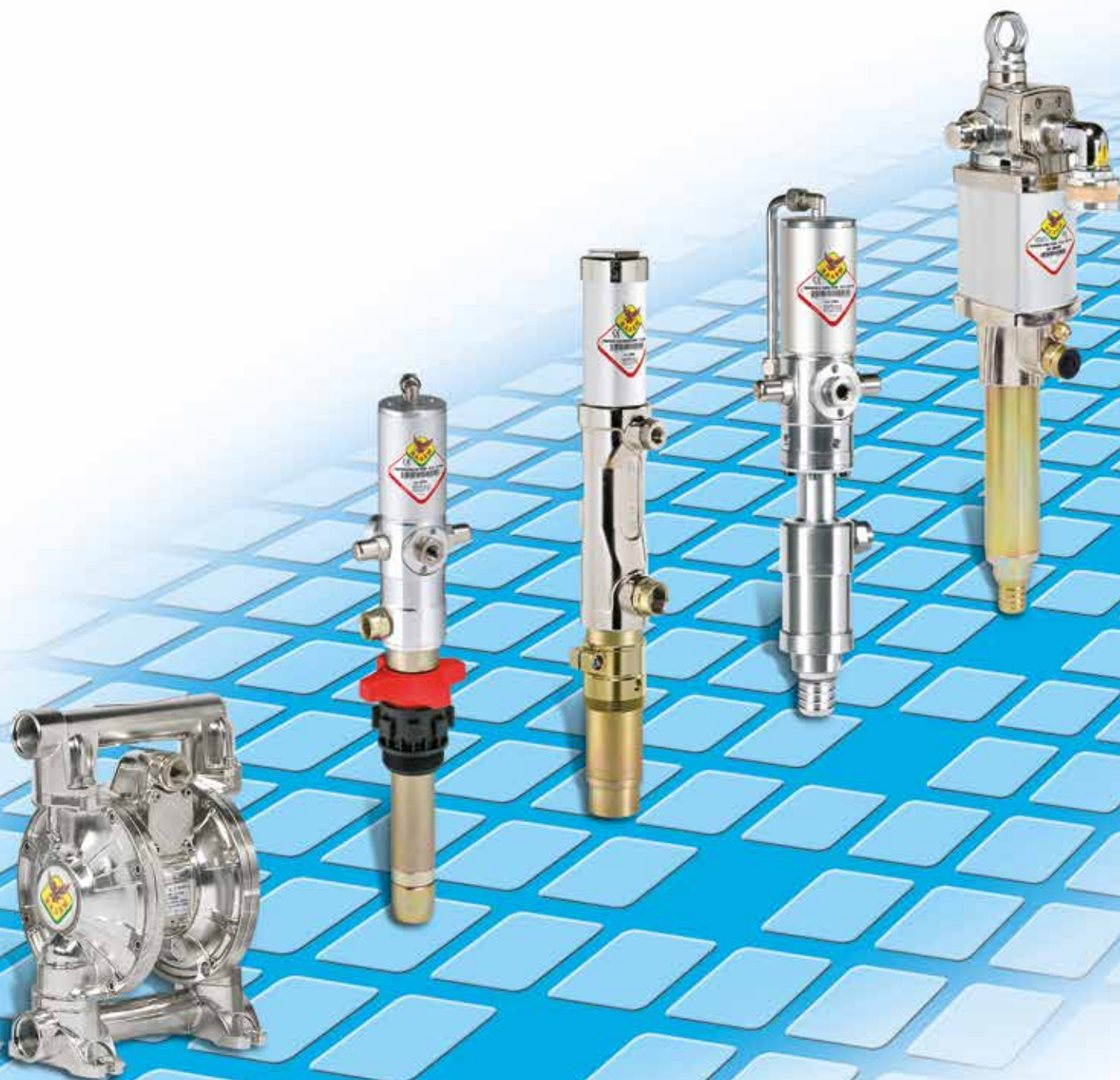

Oil pumps for transfer and distribution

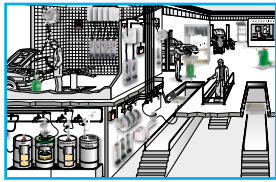

EXAMPLE OF SYSTEM AND FCS

page 68



OIL PUMPS FOR TRANSFER AND DISTRIBUTION

page 70



TROLLEY-MOUNTED - FIXED - MODULAR KITS

page 82



OIL BAR

page 92



DIGITAL METER - OIL HANDLE AND ACCESSORIES

page 94



Example of installation

All distribution lines, for oil, grease and similar products, must be prepared with tubing (in steel, rubber ...) for high pressures, and must be smooth and seamless, with connections possibly having an inside diameter greater than the tube itself so as not to create any constrictions.

The tubing for an oil line must be capable of withstanding a minimum working pressure of 60 bar.

For grease installation the tubing must withstand a minimum working pressure of 600 bar.

Air and water tubing may be welded. For water, non corrosive pipework is recommended with min. pressure rating 8 - 10 bar.

For compressed air, 18 - 20 bar minimum pressure rating is recommended.

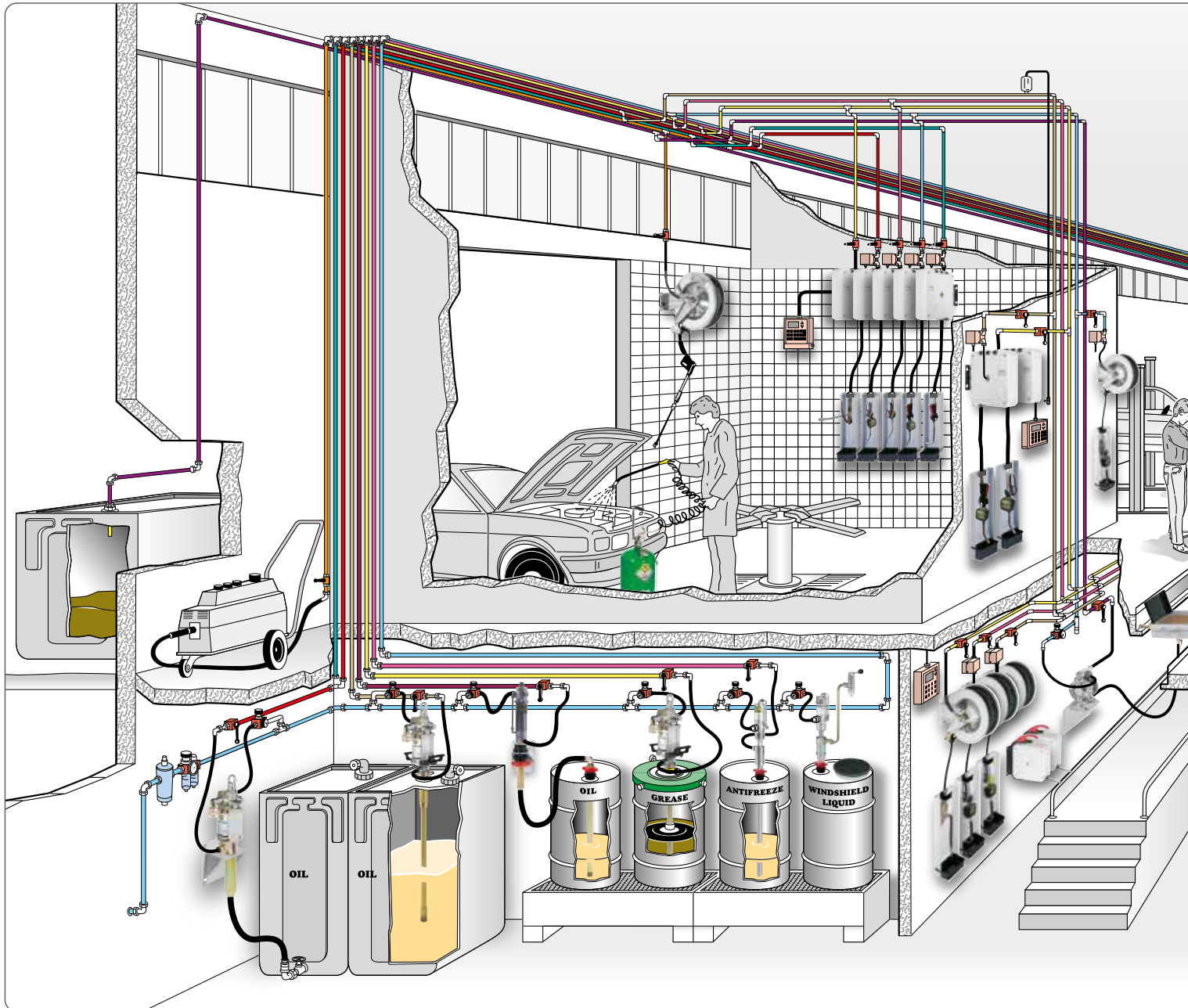

OIL

MOTOR OIL MAIN LINE

Tube characteristics:

- 0 - 15 m minimum inside diameter 3/4" (ø 19 mm)
- 16 - 50 m minimum inside diameter 1" (ø 25 mm)
- 51 - 100 m minimum inside diameter 1.1/4" (ø 30 mm)
- 101 - 200 m minimum inside diameter 1.1/2" (ø 38 mm)

Discharge: minimum inside diameter 3/4" (ø 19 mm)

GEAR OIL MAIN LINE

Tube characteristics:

- 0 - 15 m minimum inside diameter 1" (ø 25 mm)
- 16 - 50 m minimum inside diameter 1.1/4" (ø 30 mm)
- 51 - 100 m minimum inside diameter 1.1/2" (ø 38 mm)
- 51 - 250 m minimum inside diameter 2" (ø 50 mm)

Discharge: minimum inside diameter 3/4" (ø 19 mm)

...in relation to the computerized control system of fluids and the managing of stock room, please refer to the specific catalogue "FLUIDS CONTROL SYSTEM"

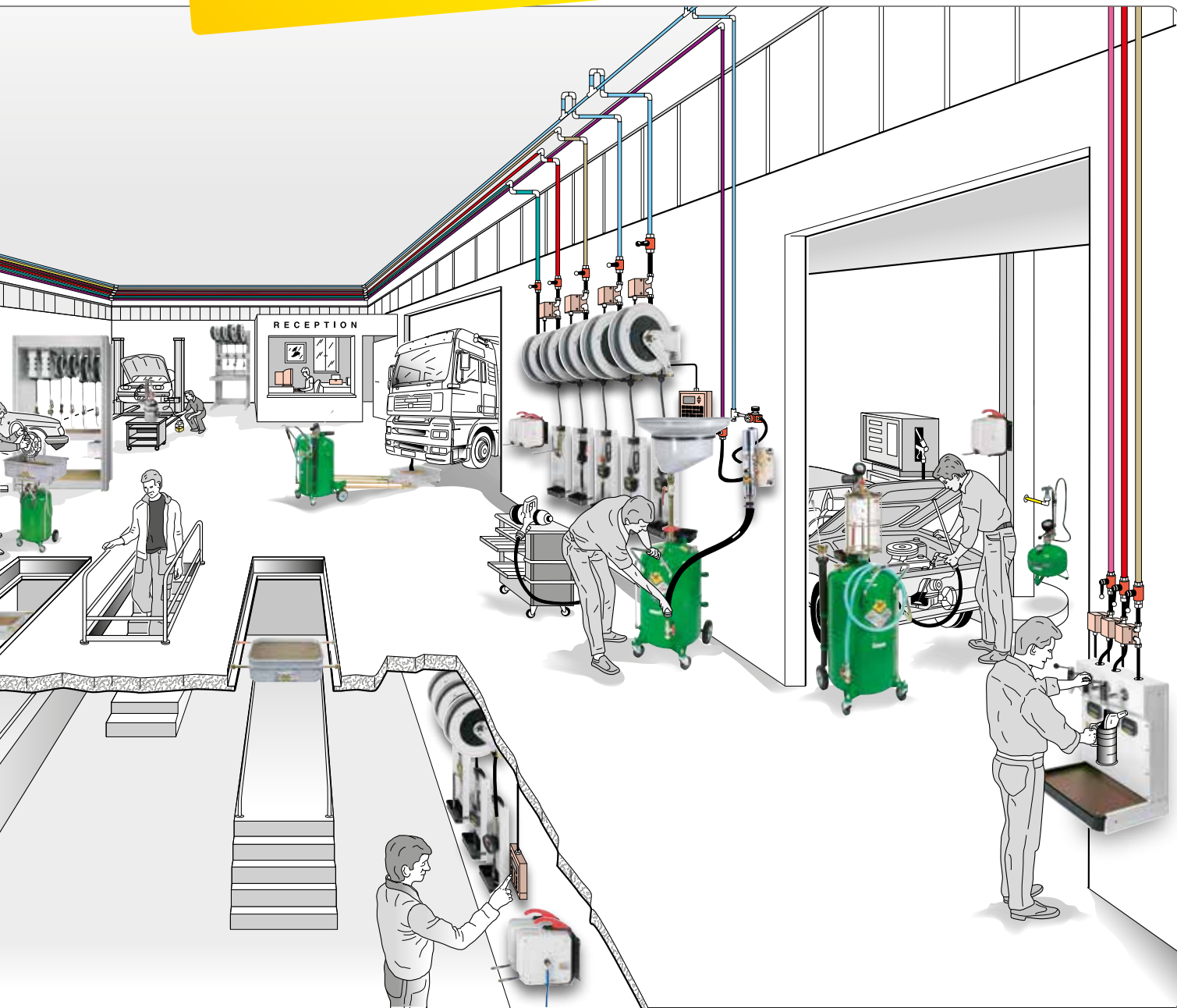

GREASE - WATER - AIR

GREASE MAIN LINE

Tube characteristics:
0 - 200 m minimum inside diameter 1/2" (ø 15 mm)

Discharge: minimum inside diameter 3/8" (ø 10 mm)

AIR AND WATER MAIN LINE

Tube characteristics:
0 - 30 m minimum inside diameter 1" (ø 25 mm)
31 - 300 m minimum inside diameter 1.1/2" (ø 38 mm)

Discharge: minimum inside diameter 3/4" (ø 19 mm)



Air-operated pumps for TRANSFER

Ratio 1:1 Flow rate 35 l/min

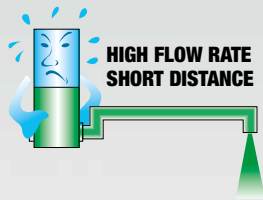

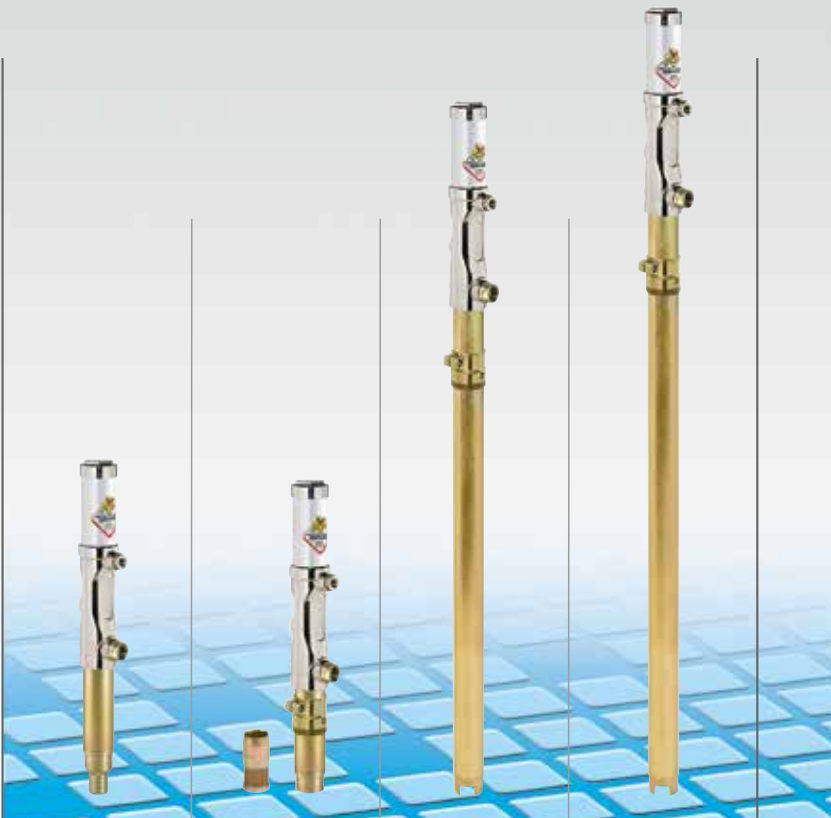

Air-operated pumps for short and medium-distance transfer.

Ideal for transferring low-medium viscosity fluids such as: oils, lubricants and similar products. The wall-mounted version of these pumps, mounted on wall or in a fixed position by means of the special accessories (refer to page 107), enables numerous uses through the application of modular extensions (refer to page 112).

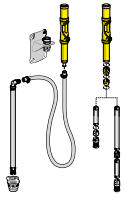
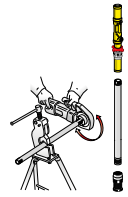

series 500

Article with seals in	NBR				
Article with seals in	Viton®	26090	26091	26093	26094
Article with seals in	Teflon®				
Compatible fluids		Oils, lubricants and similar			
Suction tube upper body		Aluminum			
Suction tube		Carbon steel			
Air inlet connection	bsp	F 1/4" G	F 1/4" G	F 1/4" G	F 1/4" G
Fluid outlet connection	bsp	F 3/4" G	F 3/4" G	F 3/4" G	F 3/4" G
Air working pressure	bar	6 - 8	6 - 8	6 - 8	6 - 8
Average air consumption	l/min	250	250	250	250
Noise level	dB	81	81	81	81
Max deliverable oil viscosity	SAE	80	80	80	80
Bung adaptor		-	standard	standard	standard
Suitable for drums or tanks		 modular	 customisable 1"	 suitable for drums 50-60 Kg	 suitable for drums 180-220 kg
Packing	N° - m ³	1 - 0,010	1 - 0,010	1 - 0,020	1 - 0,020
Weight	kg	5,5	6	7,2	7,2
Dimensions (A - B - C)	cm	33,2 - 20,8 - 5	33,2 - 16,8 - 5	33,2 - 74 - 5	33,2 - 94 - 5

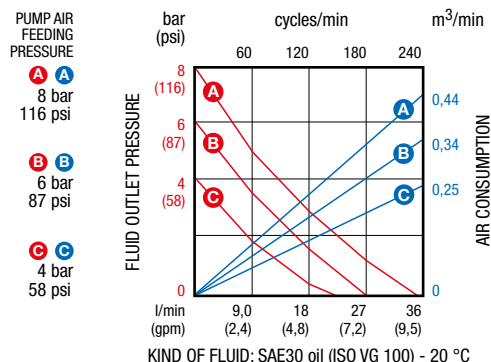
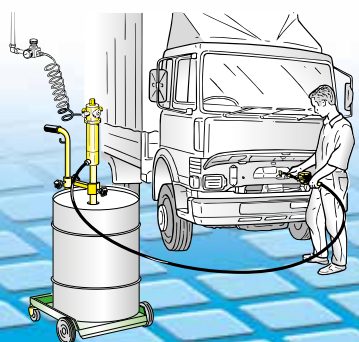

Ratio 1:1 Flow rate 23 l/min

Ratio 1:1 Flow rate 40 l/min

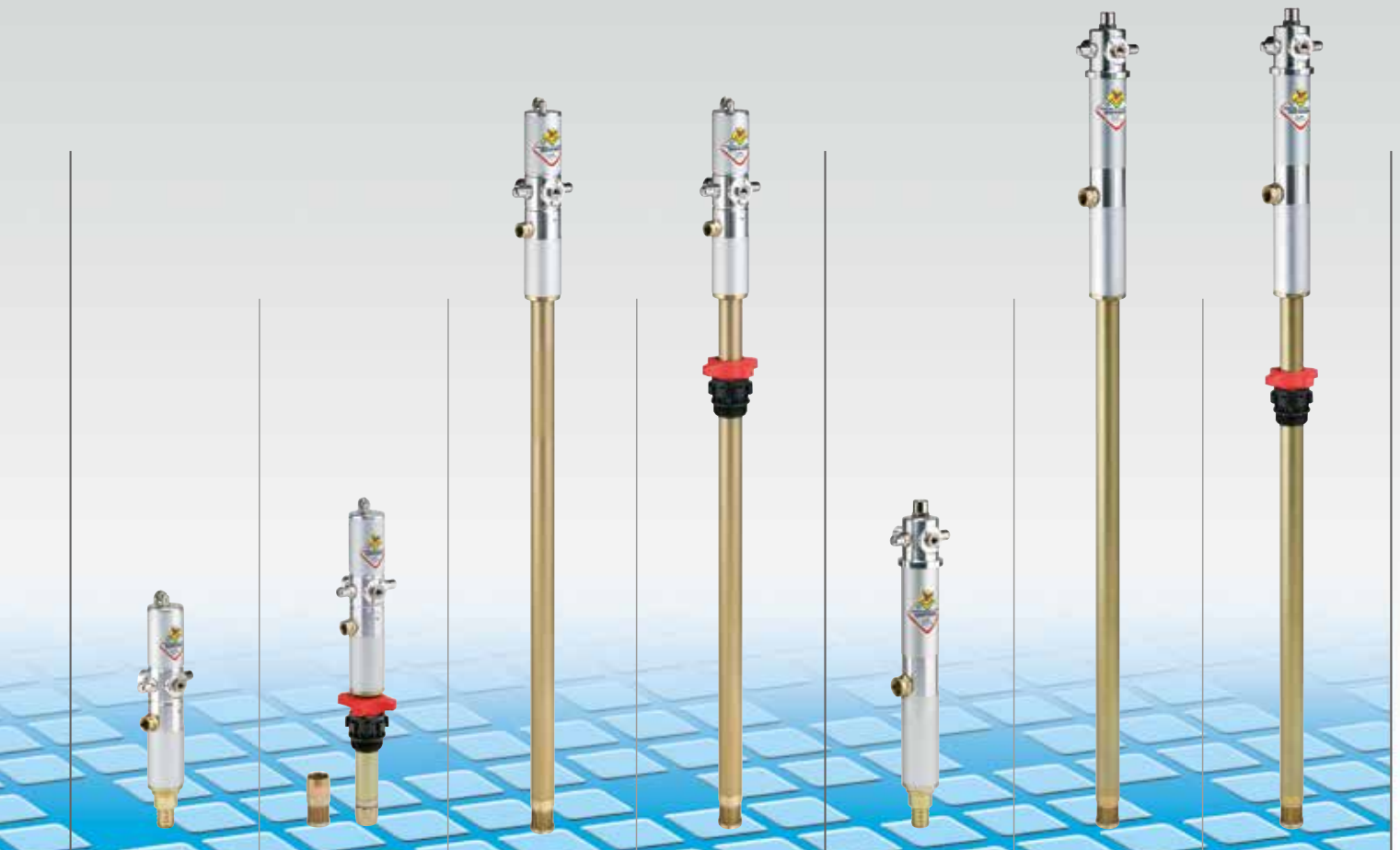

series 600

serie 650

33080
33070
33060

33081
33071
33061

33082
33072
33094

33083
33073
33096

33170
33160

33172
33194

33173
33196

Oils, lubricants and similar
Aluminum
Carbon steel

Oils, lubricants and similar
Aluminum
Carbon steel

F 1/4" G
F 1/2" G
6 - 8
230
81
80
-

F 1/4" G
F 1/2" G
6 - 8
230
81
80
standard

F 1/4" G
F 1/2" G
6 - 8
230
81
80
-

F 1/4" G
F 1/2" G
6 - 8
230
81
80
standard

F 1/4" G
F 3/4" G
6 - 8
370
81
130
-

F 1/4" G
F 3/4" G
6 - 8
370
81
130
-

F 1/4" G
F 3/4" G
6 - 8
370
81
130
standard

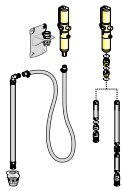

modular

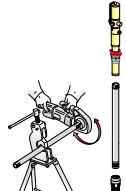

customisable 1"

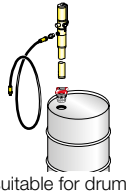

suitable for drums
180-220 kg

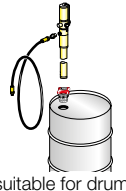

suitable for drums
180-220 kg

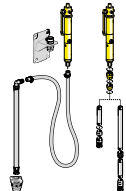

modular

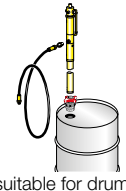

suitable for drums
180-220 kg



suitable for drums
180-220 kg

1 - 0,006

4,3
35,5 - 0 - 0

1 - 0,006

5
35,5 - 22 - 4,2

1 - 0,020

6,2
35,5 - 94 - 4,2

1 - 0,020

6,3
35,5 - 94 - 4,2

1 - 0,010

5,3
50,5 - 0 - 0

1 - 0,020

7,3
50,5 - 94 - 4,2

1 - 0,020

7,4
50,5 - 94 - 4,2

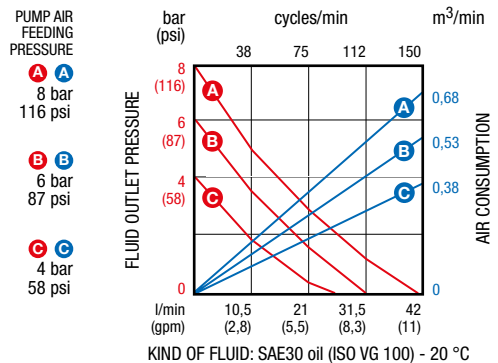
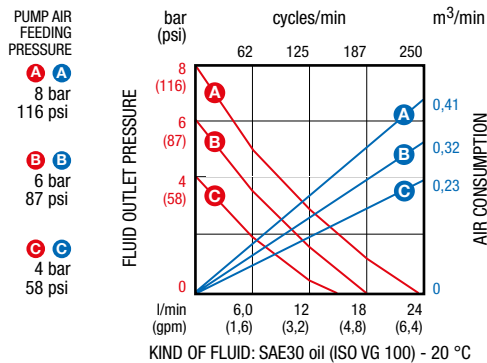



Air-operated pumps for DISTRIBUTION

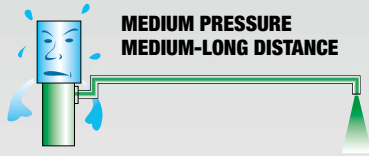

Ratio **3:1** Flow rate **20 l/min**

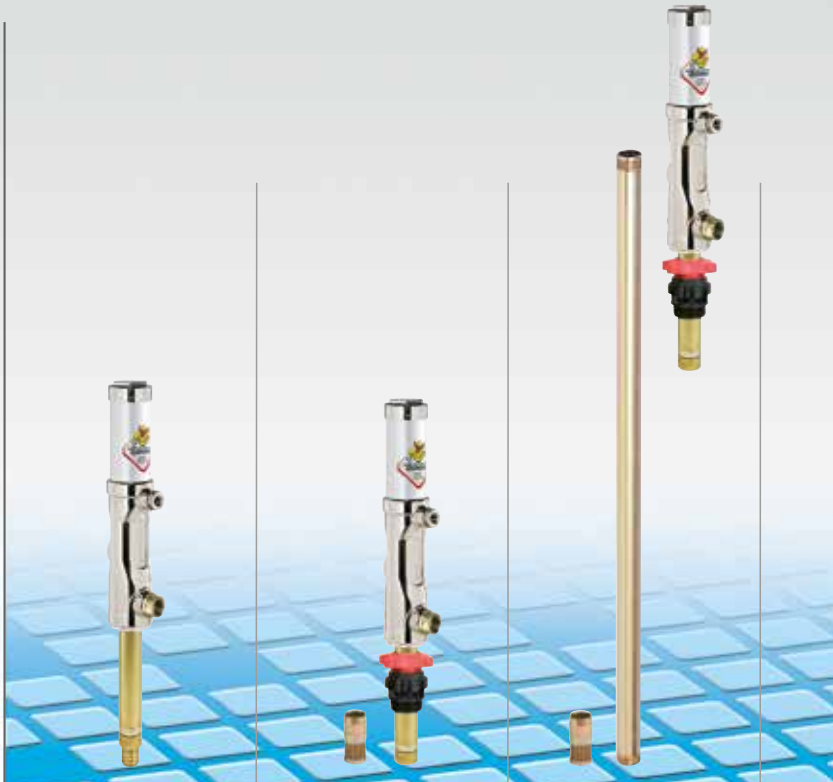

Air-operated pumps series 500 and 600 for medium distance distribution. Ideal for transferring low-medium viscosity fluids such as: oils, lubricants and similar products. Suitable for mobile unit or fixed installation. The wall-mounted version of these pumps, mounted on wall or in a fixed position by means of the special accessories (refer to page 107), enables numerous uses through the application of modular extensions (refer to page 112).

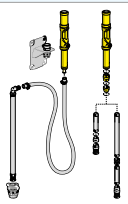
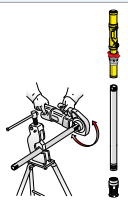
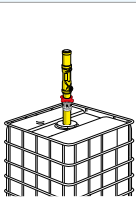

series 500

Article with seals in	NBR			
Article with seals in	NBR			
Article with seals in	Viton®	35060	35061	35063
Compatible fluids		Oils, lubricants and similar		
Suction tube upper body		Aluminum		
Suction tube		Carbon steel		
Air inlet connection	bsp	F 1/4" G	F 1/4" G	F 1/4" G
Fluid outlet connection	bsp	F 1/2" G	F 1/2" G	F 1/2" G
Air working pressure	bar	6 - 8	6 - 8	6 - 8
Average air consumption	l/min	350	350	350
Noise level	dB	81	81	81
Max deliverable oil viscosity	SAE	130	130	130
Bung adaptor		-	standard	standard
Suitable for drums or tank		 modular	 customisable 1"	 tank
Packing	 N° - m ³	1 - 0,01	1 - 0,01	1 - 0,01
Weight	 kg	5,35	5,8	5,8
Dimensions (A - B - C)	cm	33,2 - 20 - 3,2	33,2 - 18,5 - 3,2	33,2 - 125 - 3,2

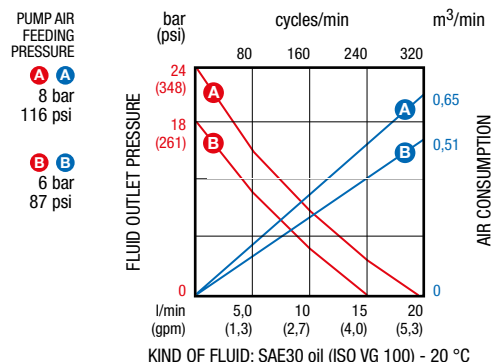

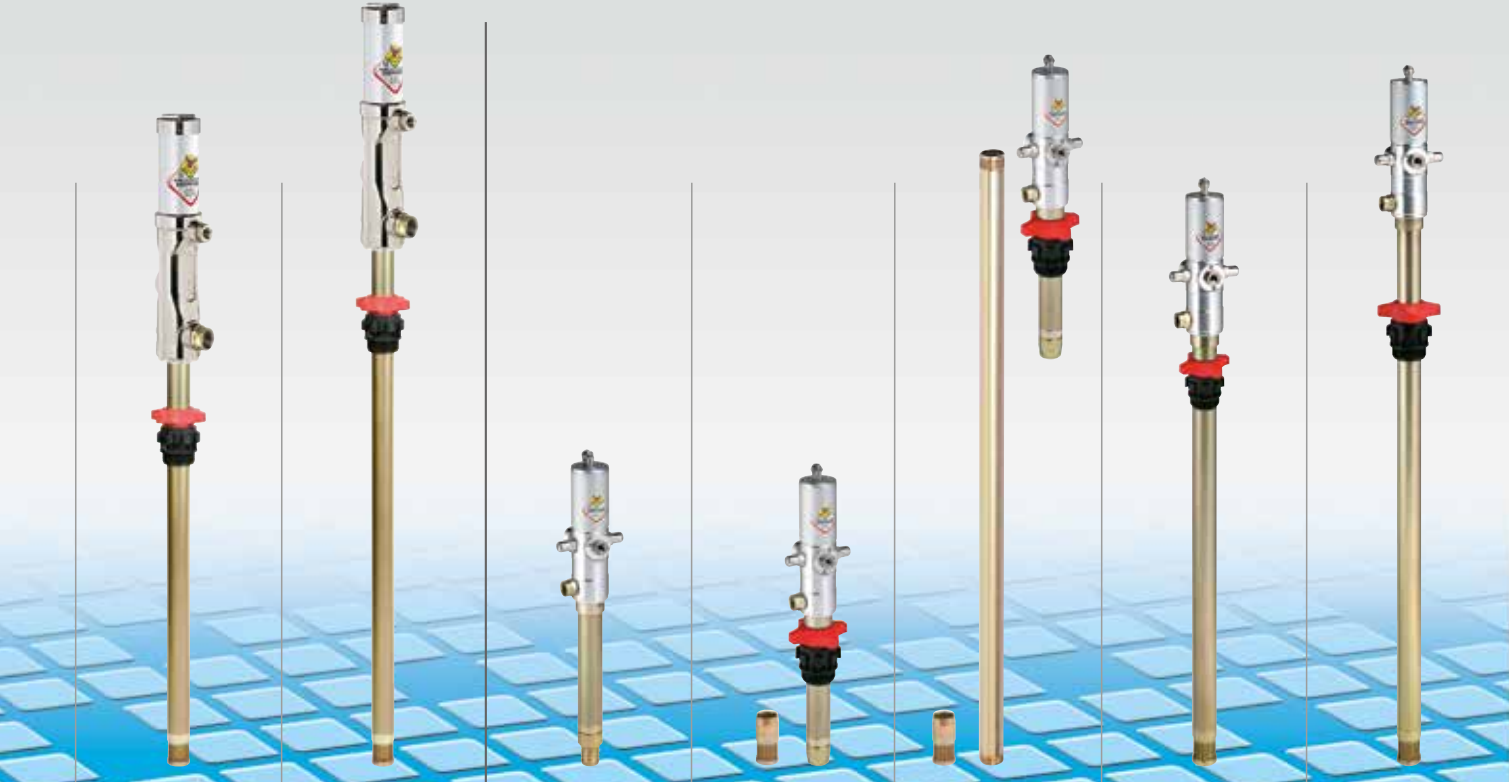

series 500		series 600				
		35160	35161	35163	35173	35194
					35176	35196
35076	35094					
Oils, lubricants and similar Aluminum Carbon steel		Oils, lubricants and similar Aluminum Carbon steel				
F 1/4" G	F 1/4" G	F 1/4" G	F 1/4" G	F 1/4" G	F 1/4" G	F 1/4" G
F 1/2" G	F 1/2" G	F 1/2" G	F 1/2" G	F 1/2" G	F 1/2" G	F 1/2" G
6 - 8	6 - 8	6 - 8	6 - 8	6 - 8	6 - 8	6 - 8
350	350	330	330	330	330	330
81	81	81	81	81	81	81
130	130	130	130	130	130	130
standard	standard	-	standard	standard	standard on 35176	standard on 35196
suitable for drums 50-60 kg	suitable for drums 180-220 kg	modular	customisable 1"	tank	suitable for drums 50-60 kg	suitable for drums 180-220 kg
1 - 0,01	1 - 0,01	1 - 0,01	1 - 0,01	1 - 0,02	1 - 0,020	1 - 0,020
5,8	6,5	4,4	5,0	6,8	5,8	6,5
33,2 - 74 - 3,2	33,2 - 94 - 3,2	28,5 - 28,5 - 4,2	28,5 - 22 - 4,2	28,5 - 125 - 4,2	28,5 - 74 - 4,2	28,5 - 94 - 4,2

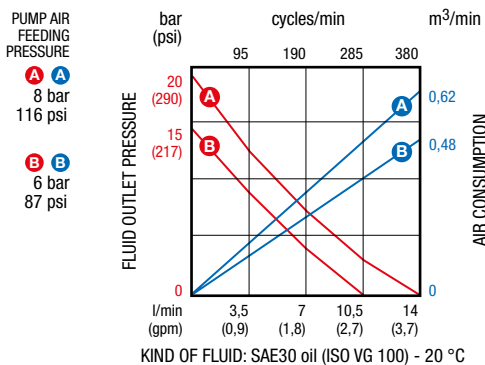
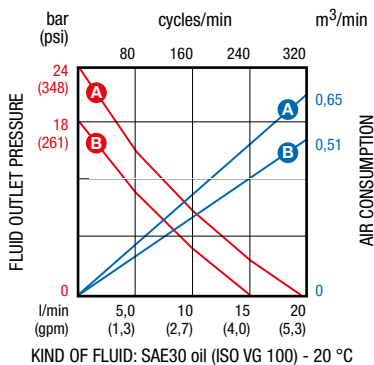



Air-operated pumps for DISTRIBUTION

Ratio **5:1** Flow rate **18 l/min**

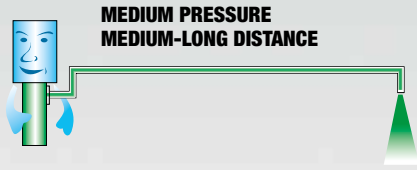

Series 650 air-operated double-acting pumps for medium distance oil distribution. Ideal for also distributing high viscosity oil. The double action guarantees the delivery of a continuous and constant flow, ideal for all installations, excellent for centralised distribution systems. The wall-mounted version of these pumps, mounted on wall or in a fixed position by means of the special accessories (refer to page 107), enables numerous uses through the application of modular extensions (refer to page 112).

Article with seals in **NBR**

Article with seals in **NBR**

Compatible fluids		Medium/high-viscosity oil		
Suction tube upper body		Aluminum		
Suction tube		Carbon steel		
Air inlet connection	bsp	F 1/4" G	F 1/4" G	F 1/4" G
Fluid outlet connection	bsp	F 1/2" G	F 1/2" G	F 1/2" G
Air working pressure	bar	6 - 8	6 - 8	6 - 8
Average air consumption	l/min	350	350	350
Noise level	dB	81	81	81
Max deliverable oil viscosity	SAE	240	240	240
Bung adaptor		-	standard	standard

Suitable for drums or tanks

Packing	N° - m ³	1 - 0,01	1 - 0,01	1 - 0,02
Weight	kg	4,7	5,2	7,2
Dimensions (A - B - C)		cm	34,5 - 27 - 4,2	34,5 - 125 - 4,2



series 650

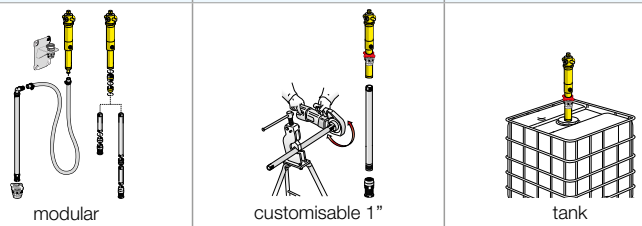

PUMP AIR FEEDING PRESSURE

- A A** 8 bar 116 psi
- B B** 6 bar 87 psi
- C C** 4 bar 58 psi

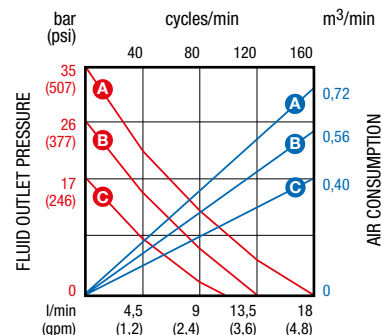

KIND OF FLUID: SAE30 oil (ISO VG 100) - 20 °C

Advantages of double-action

There are many technical solutions for obtaining a reciprocating double-acting pump.

The double-action of RAASM pumps is obtained with solutions that have simplified the pump mechanism itself, ensuring that delivery of the fluid in both alternating movements (upstroke and downstroke) of the pump occurs only through the difference in volume between the diameters of the pumping piston (A) and the pump shaft (B).

On the **upstroke**, delivery is caused by the **pumping piston (A)**.

On the **downstroke** it is caused by the difference in **volume between the diameter of the motor shaft (B) and the diameter of the pumping piston (A)**.



series 650

36073

36094

36076

36096

Medium/high-viscosity oil

Aluminum

Carbon steel

F 1/4" G

F 1/4" G

F 1/2" G

F 1/2" G

6 - 8

6 - 8

350

350

81

81

240

240

standard on 36076

standard on 36096



suitable for drums
50-60 kg

1 - 0,02

6,2

34,5 - 74 - 4,2



suitable for drums
180-220 kg

1 - 0,02

6,8

34,5 - 94 - 4,2

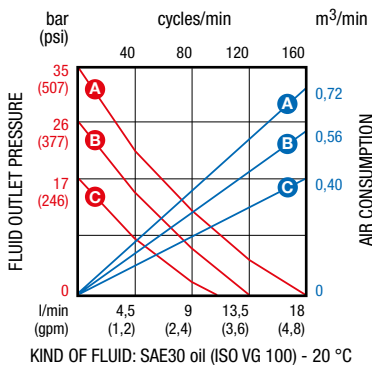
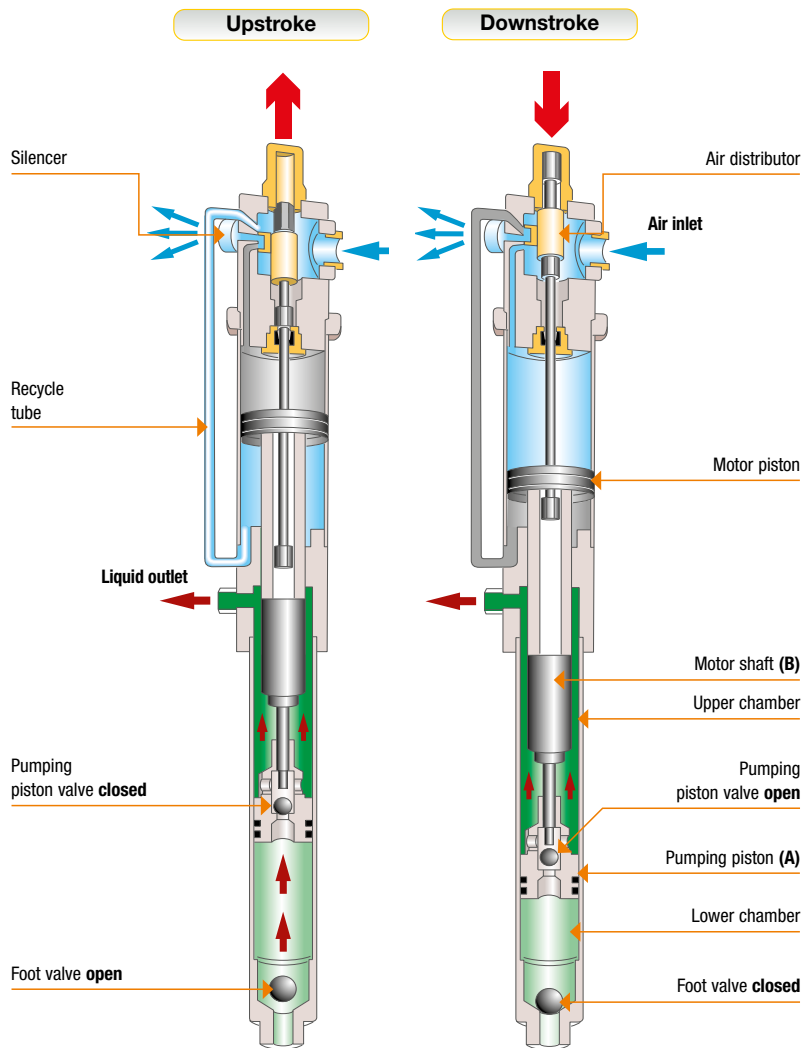

In addition to guaranteeing regular delivery of the fluid, this solution offers the further advantage of having fewer parts inside the pump. This means less wear plus greater and longer reliability.



Stainless steel AISI 304 pumps for TRANSFER

Ratio 1:1 Flow rate 30 l/min

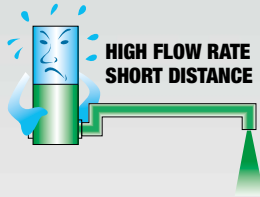

Stainless steel AISI 304 air-operated pumps for short-medium distance transfer. Ideal for transferring low-medium viscosity fluids such as: antifreeze liquid, windshield washing liquid and chemical products.

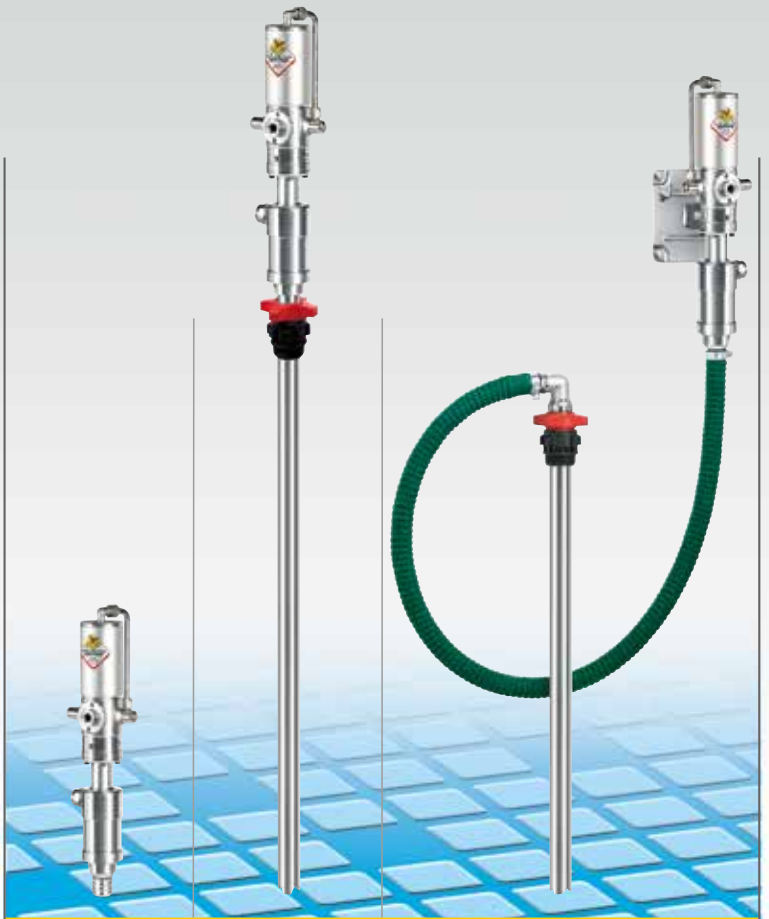
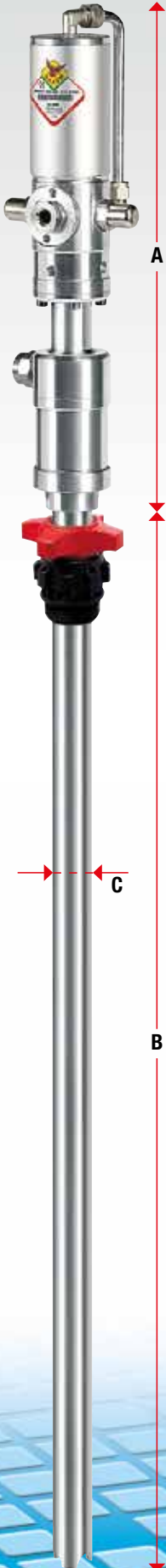

series 600 INOX

Article with seals in	Viton®	33360	33396	33300
Compatible fluids		Suitable for antifreeze and windshield washing liquid		
Suction tube lower body		Stainless steel AISI 304		
Suction tube		Stainless steel AISI 304		
Air inlet connection	bsp	F 1/4" G	F 1/4" G	-
Fluid outlet connection	bsp	F 1/2" G	F 1/2" G	-
Air working pressure	bar	6 - 8	6 - 8	-
Average air consumption	l/min	370	370	-
Noise level	dB	81	81	-
Max deliverable oil viscosity	SAE	50	50	-
Bung adaptor		-	standard	33434
Suitable for drums or tanks				
		modular	suitable for drums 180-220 kg	modular
Packing	N° - m ³	1 - 0,10	1 - 0,020	1 - 0,29
Weight	kg	5,3	7,4	11,4
Dimensions (A - B - C)	cm	41 - 0 - 0	41 - 94 - 3,4	41 - 94 - 3,4

Art. 33445
Gun for antifreeze and windshield liquid
 applicable to kit Art. 33300 equipped with:
 - inlet joint F 1/2"
 - stainless steel rigid terminal with free outlet

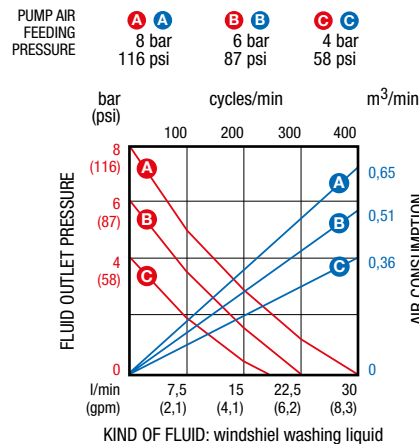

Art. 33360
 Art. 33115
 Art. 33426
 Art. 33427
 Art. 33434



DIAPHRAGM Pumps

S. 340-AB

in aluminum

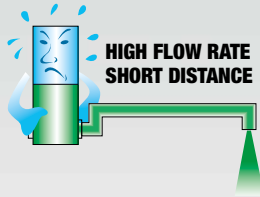

The transfer diaphragm pumps, specific for oil and similar products in die-cast aluminum, with high-quality components, ensure lasting and reliable operation even in extreme conditions. Ideal for transferring fluids even in the presence of suspended solids.



series 340-AB

Article with membrane in NBR High Nitrile	33/2011NHHV2	33500	33505
Compatible fluids	Water, mineral-vegetable oils, diesel oil		
Pump material	Aluminum		
Ball valve material	Hytrell®		
Air inlet connection	bsp F 3/8" G	F 3/8" G	F 3/8" G
Fluid inlet-outlet connection	bsp F 3/4" x F 3/4" G	suction tube ø 34 mm - F 3/4" G	suction tube ø 34 mm - F 3/4" G
Air working pressure	bar 2 - 6	2 - 6	2 - 6
Air max pressure	bar 8	8	8
Average air consumption	l/min 500	500	500
Noise level	dB 75	75	75
Fluid temperature	°C -10 +90	-10 +90	-10 +90
Max solids diameter	mm ø 1,5	ø 1,5	ø 1,5
Suitable for drums or tanks	modular	suitable for drums 180-220 kg	tank
Suction-delivery ball valve with spring			
Packing	N° - m ³ 1 - 0,015	2 - 0,040	2 - 0,040
Weight	kg 8	10	11
Dimensions (A - B - C)	cm 16 - 20 - 25,6	16 - 20 - 25,6	16 - 20 - 25,6
Suction tube length and ø	cm -	94x3,4	124x3,4

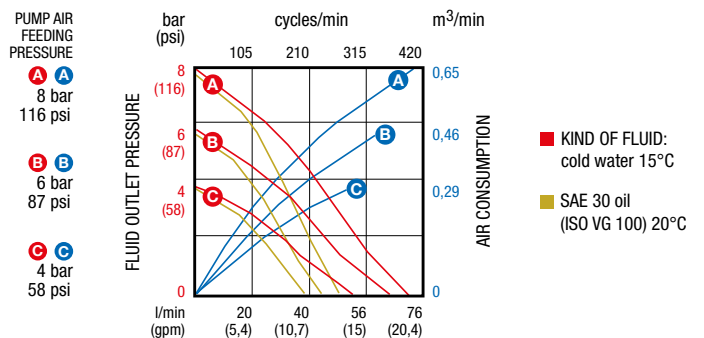
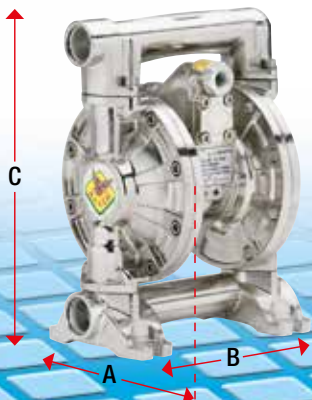



DIAPHRAGM Pumps

S. 1000-AB - 1140-AB

in aluminum

1" Ratio 1:1
Flow rate **170 l/min**

1.1/4" Ratio 1:1
Flow rate **200 l/min**

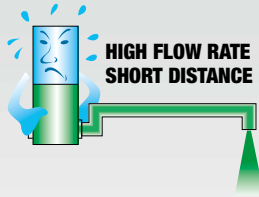

The transfer diaphragm pumps, specific for oil and similar products in die-cast aluminum, with high-quality components, ensure lasting and reliable operation even in extreme conditions. Ideal for transferring fluids even in the presence of suspended solids.



series 1000-AB
33/2611NHHV2

series 1140-AB
33/3011NHHV2

Article with membrane in **NBR High Nitrile**

Compatible fluids	Water, mineral-vegetable oils, diesel oil	Water, mineral-vegetable oils, diesel oil
Pump material	Aluminum	Aluminum
Ball valve material	Hytrel®	Hytrel®
Air inlet connection	bsp F 3/8" G	bsp F 3/4" G
Fluid inlet-outlet connection	bsp F 1.1/4" x F 1" G	bsp F 1.1/4" x F 1.1/4" G
Air working pressure	bar 2 - 6	bar 2 - 6
Air max pressure	bar 8	bar 8
Average air consumption	l/min 1200	l/min 1400
Noise level	dB 75	dB 75
Fluid temperature	°C -10 +90	°C -10 +90
Max solids diameter	mm ø 3	mm ø 3
Suction-delivery ball valve with spring		
Packing	N° - m ³ 1 - 0,025	N° - m ³ 1 - 0,041
Weight	kg 14	kg 16
Dimensions (A - B - C)	cm 20 - 26 - 34,5	cm 23,8 - 28,6 - 38,6

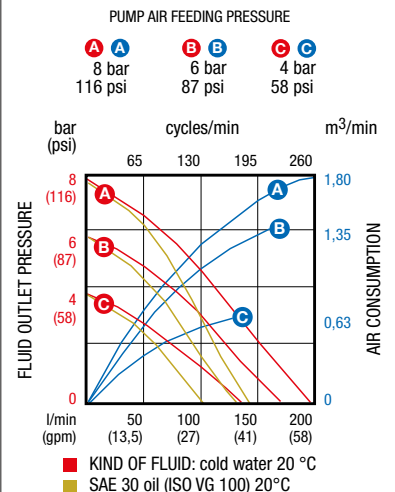
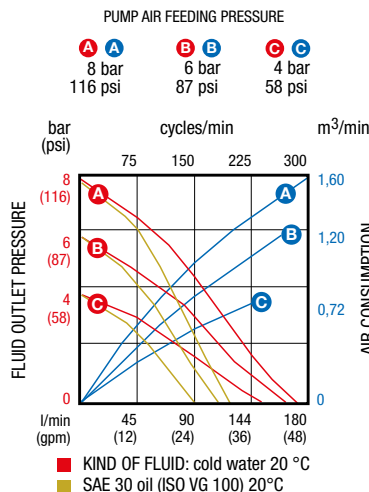



DIAPHRAGM Pumps S. 120-PB

in polypropylene

1/2" Ratio 1:1
Flow rate 60 l/min

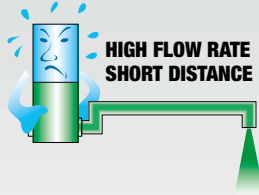

Diaphragm pumps are used in different kind of application. They can be installed on wall brackets, on trailers, on moving machines, on drums, on big reservoirs and in many other places. Ideal for transferring fluids even in the presence of suspended solids. Double inlet version is suitable to mix together two different kind of liquids i. e. water and antifreeze.

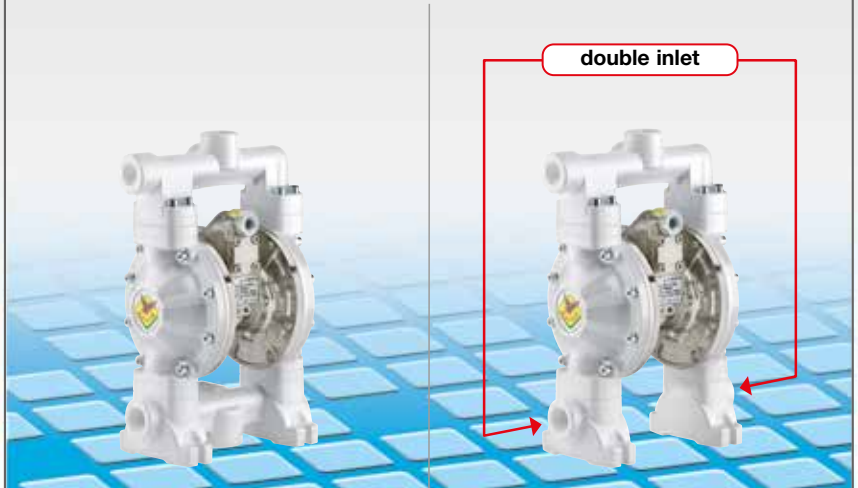

series 120-PB

series 120-PB

Article with membrane	NBR High Nitrile	2B3/16117NH52		2B8/16117NH52	
Article with membrane	PTFE		2B3/16117TT52		2B8/16117TT52
Compatible fluids		Water, mineral-vegetable oils, diesel oil	Windshield washing liquid and antifreeze	Water, mineral-vegetable oils, diesel oil	Windshield washing liquid and antifreeze
Motor and inside flanges material		Aluminum	Aluminum	Aluminum	Aluminum
Wetted parts		Polypropylene	Polypropylene	Polypropylene	Polypropylene
Ball valve material		Hytrel®	Teflon®	Hytrel®	Teflon®
Air inlet connection	bsp	F 3/8" G	F 3/8" G	F 3/8" G	F 3/8" G
Fluid inlet-outlet connection	bsp	F 3/4" x F 1/2" G	F 3/4" x F 1/2" G	F 3/4" x F 1/2" G	F 3/4" x F 1/2" G
Air working pressure	bar	2 - 6	2 - 6	2 - 6	2 - 6
Air max pressure	bar	8	8	8	8
Average air consumption	l/min	400	400	400	400
Noise level	dB	75	75	75	75
Fluid temperature	°C	-10 +65	-10 +65	-10 +65	-10 +65
Max solids diameter	mm	ø 1,5	ø 1,5	ø 1,5	ø 1,5
Suction-delivery ball valve with spring					
Packing	N° - m ³	1 - 0,015	1 - 0,015	1 - 0,015	1 - 0,015
Weight	kg	7,5	7,5	7	7
Dimensions (A - B - C)	cm	17,8 - 21,8 - 32,6	17,8 - 21,8 - 32,6	17,8 - 22 - 32,6	17,8 - 22 - 32,6

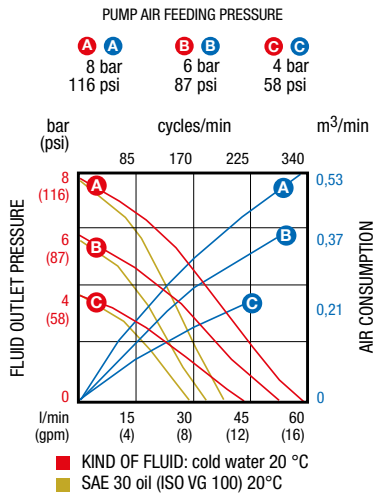



Air-operated pumps for DISTRIBUTION

Ratio **5:1** Flow rate **45 l/min**

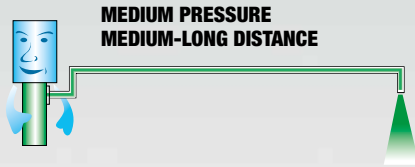

Series 900 industrial air-operated double-acting pumps for distribution. Suitable for transferring oils, lubricants and similar products also with very high viscosity. The double action guarantees the delivery of a continuous and constant flow, ideal for all needs. Particularly effective in systems equipped with several distribution points.



series **900**

Article with seals in	PU
Compatible fluids	Oils, lubricants and similar
Suction tube upper body	Aluminum
Suction tube	Carbon steel
Air inlet connection	bsp F 1/2"
Fluid outlet connection	bsp F 3/4"
Air max pressure	bar 8
Max air consumption 8 bar	m ³ /min 1,6
Noise level	dB 80
Suitable for drums or tanks	
Packing	N° - m ³ 1 - 0,040
Weight	kg 12
Dimensions (A - B - C)	cm 43 - 23 - 6,2



modular

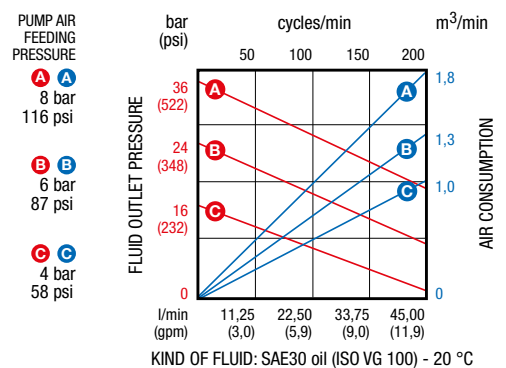

Ratio 7:1 Flow rate 30 l/min

Ratio 11:1 Flow rate 30 l/min

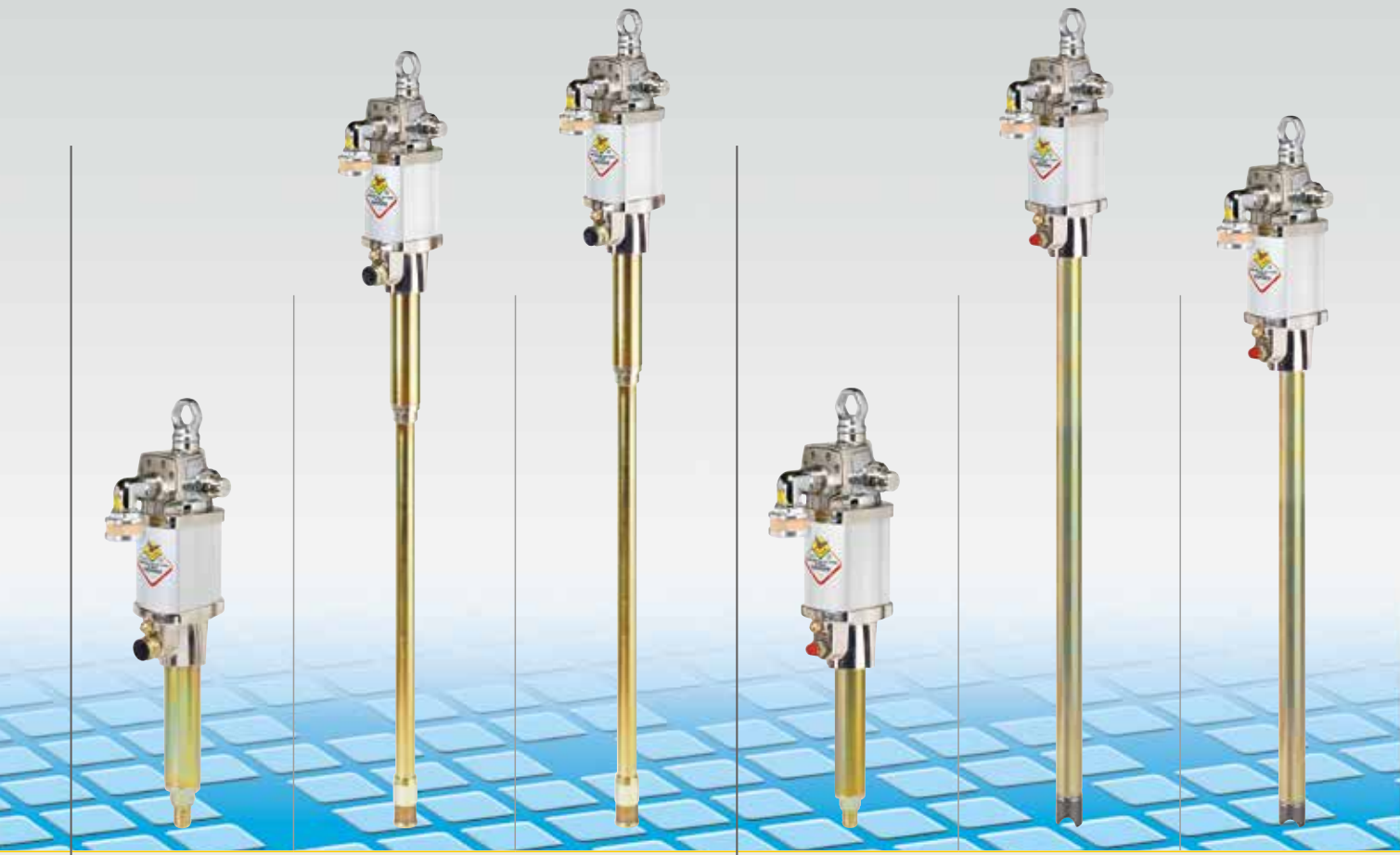

series 900

series 900

90C/71	91C/71	92C/71	90C/111	91C/111	92C/111
Oils, lubricants and similar			Oils, lubricants and grease		
Aluminum			Aluminum		
Carbon steel			Carbon steel		
F 1/2"	F 1/2"	F 1/2"	F 1/2"	F 1/2"	F 1/2"
F 3/4"	F 3/4"	F 3/4"	F 3/4"	F 3/4"	F 3/4"
8	8	8	8	8	8
1,6	1,6	1,6	1,7	1,7	1,7
80	80	80	80	80	80
modular	suitable for drums 180-220 kg	tank	modular	suitable for drums 180-220 kg	suitable for drums 50-60 kg
1 - 0,040	1 - 0,070	1 - 0,080	1 - 0,040	1 - 0,070	1 - 0,070
11	13	15	11	16	15
43 - 27 - 5,3	43 - 94 - 5,3	43 - 126 - 5,3	43 - 27 - 4,5	43 - 94 - 4,5	43 - 74 - 4,5

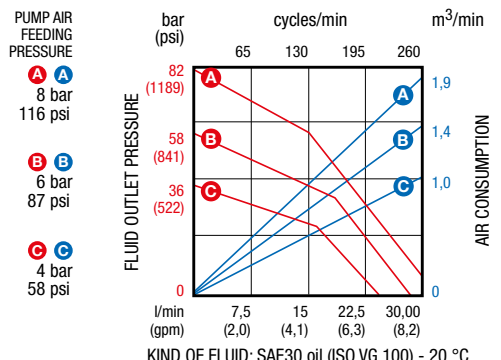
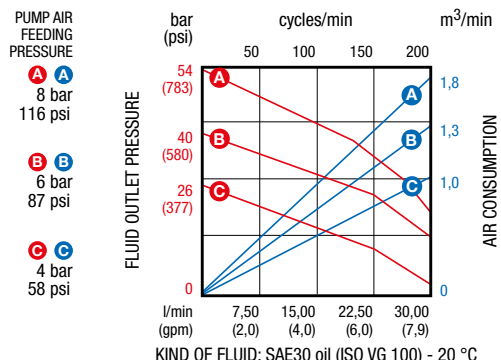



Mobile oil DISPENSER unit

trolley super
for drums 180-220 kg

Mobile oil dispenser unit.

The ideal combination for dispensing oil in any workplace. The very easy to handle trolley is equipped with a drum (180 - 220 kg) clamping device, adjustable side support for stowing accessories, wheel with brake. The unit comes with a handy hose reel with 10 m of hose, and digital hose end meter.



Article		35201	35200	37100	35209	35210	37150
Ratio		3:1	3:1	5:1	3:1	3:1	5:1
Flow rate	l/min	20	14	18	20	14	18
Pump	Art.	35094	35194	36094	35094	35194	36094
Trolley	Art.	80201	80201	80201	80201	80201	80201
Hose reel	Art.	8430.401	8430.401	8430.401	-	-	-
Bung adaptor	Art.	38046	38042	38042	38046	38042	38042
Nipple	Art.	38071	38071	38071	38071	38071	38071
Digital metering gun	Art.	37758	37758	37758	37758	37758	37758
Hose	Art.	996.302	996.302	996.302	996.304	996.304	996.304
Packing	N° - m³	4 - 0,210	4 - 0,210	4 - 0,210	3 - 0,176	3 - 0,176	3 - 0,176
Weight	kg	74	76	76	55	57	57
Dimensions (A - B - C) cm		93 - 81 - 143	93 - 81 - 138,5	93 - 81 - 144,5	93 - 81 - 143	93 - 81 - 138,5	93 - 81 - 144,5

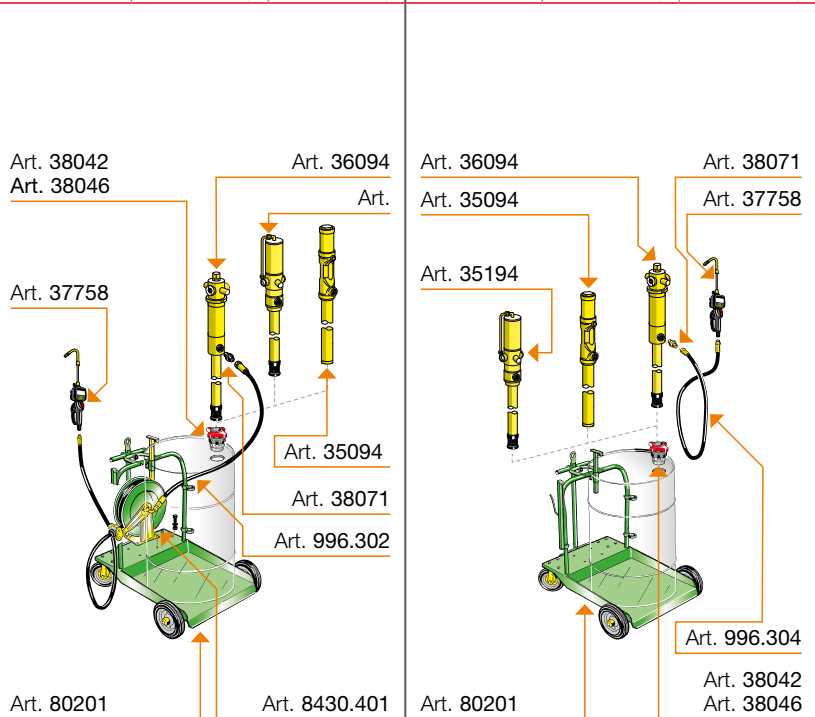
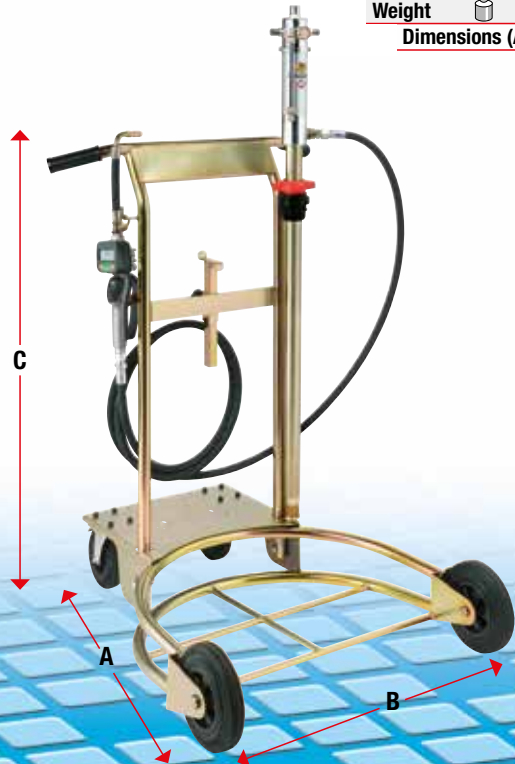

trolley standard
for drums 180-220 kg

trolley light
for drums 180-220 kg



35198	35199	37099	35415	35425	37095	35219	35220	37200
3:1	3:1	5:1	3:1	3:1	5:1	3:1	3:1	5:1
20	14	18	20	14	18	20	14	18
35094	35194	36094	35094	35194	36094	35094	35194	36094
80210	80210	80210	80210	80210	80210	80200	80200	80200
8430.401	8430.401	8430.401	-	-	-	-	-	-
38046	38042	38042	38046	38042	38042	38046	38042	38042
38071	38071	38071	38071	38071	38071	38071	38071	38071
37758	37758	37758	37758	37758	37758	37758	37758	37758
996.302	996.302	996.302	996.304	996.304	996.304	996.304	996.304	996.304
4 - 0,28	4 - 0,28	4 - 0,28	3 - 0,246	3 - 0,246	3 - 0,246	3 - 0,121	3 - 0,121	3 - 0,121
54,6	56,1	56,2	35,8	37,3	37,4	33,3	33,3	34,1
90-77-133	90 - 77 - 128,5	90-77-134,5	90-77-133	90 - 77 - 128,5	90-77-134,5	67-77-138,5	67-77-132,5	67-77-139,5

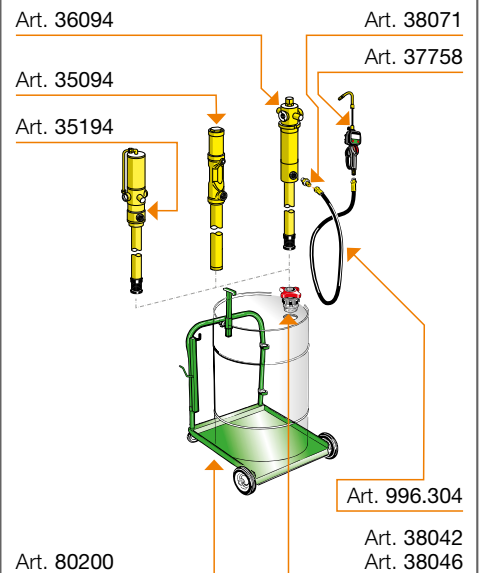
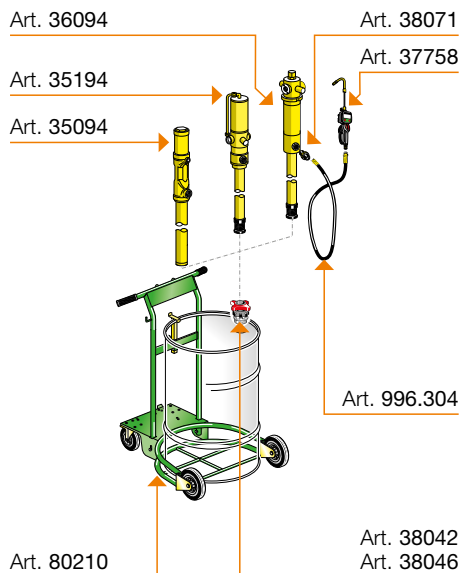
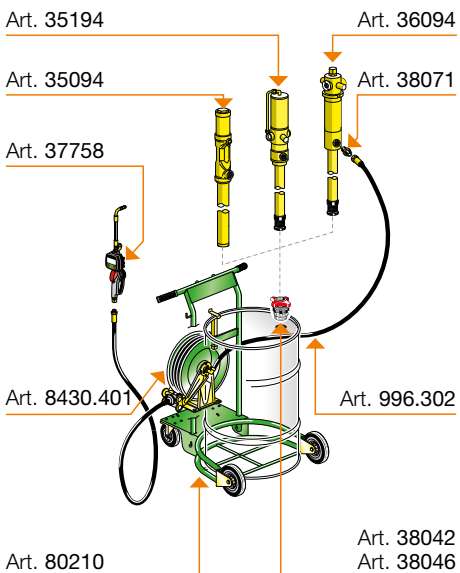



Oil DISPENSER kit

with 65 l tank

Trolley-mounted oil dispenser kit.

The ideal combination for dispensing oil in any workplace. The compact trolley has 2 fixed wheels and 2 castors that make it very easy to handle. It is equipped with a pump support and is suitable for holding various types of containers (30 - 50 kg).



Article		35265	37650	35270	37670
Ratio		3:1	5:1	3:1	5:1
Flow rate	l/min	14	18	14	18
Pump	Art.	35173	36073	35173	36073
Nipple	Art.	38071	38071	38071	38071
Digital metering gun	Art.	37758	37758	38022	38022
Hose	Art.	996.304	996.304	996.304	996.304
Antisplash funnel	Art.	24891	24891	24891	24891
Trolley	Art.	-	-	-	-
Bung adaptor	Art.	-	-	-	-
Drum cover	Art.	-	-	-	-
Packing	N° - m ³	3 - 0,230	3 - 0,230	3 - 0,230	3 - 0,230
Weight	kg	33	34	30,9	31,3
Dimensions (A - B - C)	cm	60 - 60 - 145,5	60 - 60 - 145,5	60 - 60 - 145,5	60 - 60 - 145,5

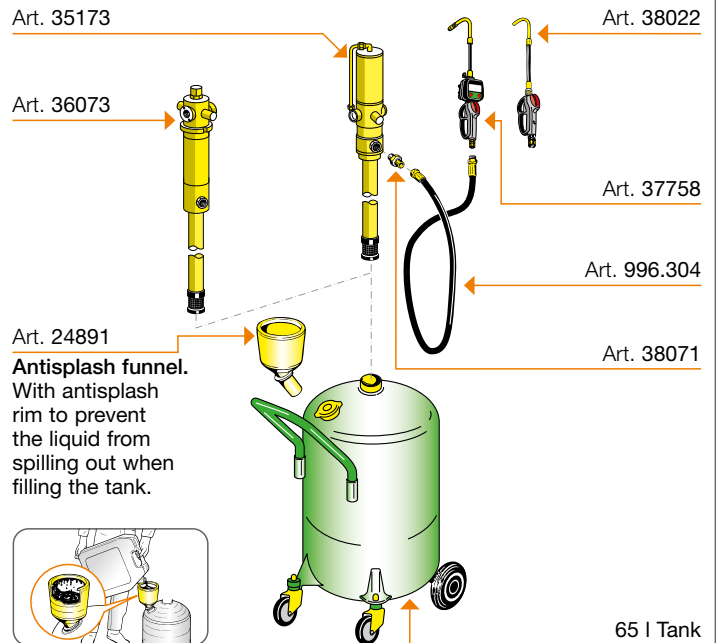
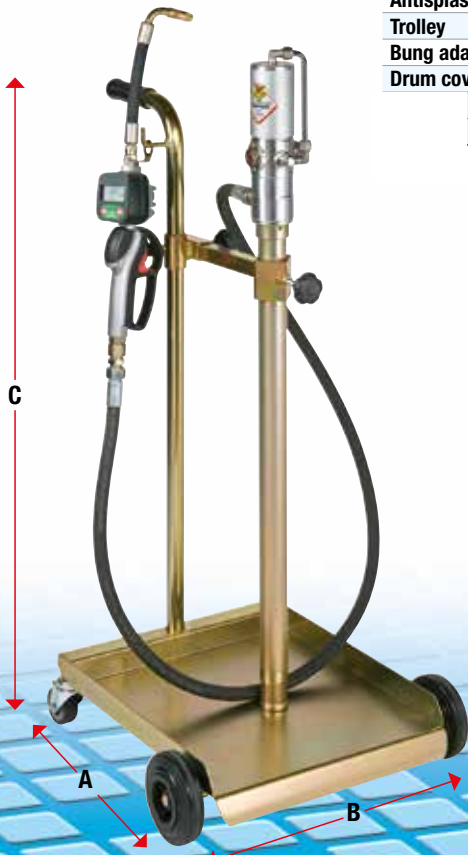

trolley for drums 30 - 60 kg

kit for drums 30 - 60 kg



35260	35250	37500	35249	35259	37499	35264	35254	37504
3:1	3:1	5:1	3:1	3:1	5:1	3:1	3:1	5:1
20	14	18	20	14	18	20	14	18
35076	35173	36073	35076	35173	36073	35076	35173	36073
38071	38071	38071	38071	38071	38071	38071	38071	38071
37758	37758	37758	37758	37758	37758	37758	37758	37758
996.304	996.304	996.304	996.304	996.304	996.304	996.304	996.304	996.304
-	-	-	-	-	-	-	-	-
80050	80050	80050	-	-	-	-	-	-
-	-	-	38046	38042	38042	38046	38042	38042
-	-	-	-	-	-	65138	65138	65138
3 - 0,085	3 - 0,085	3 - 0,085	2 - 0,044	2 - 0,041	2 - 0,041	3 - 0,087	3 - 0,084	3 - 0,084
20	20	20,5	14,7	17,1	17,3	19,2	21,6	21,8
46 - 50 - 145,5	46 - 50 - 145,5	46 - 50 - 145,5	3,2 - 3,2 - 107,2	4,2 - 4,2 - 102,5	4,2 - 4,2 - 108,5	40 - 40 - 107,2	40 - 40 - 102,5	40 - 40 - 108,5

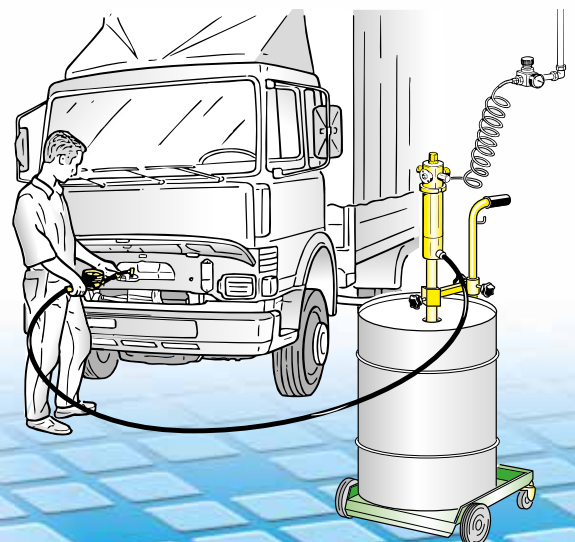
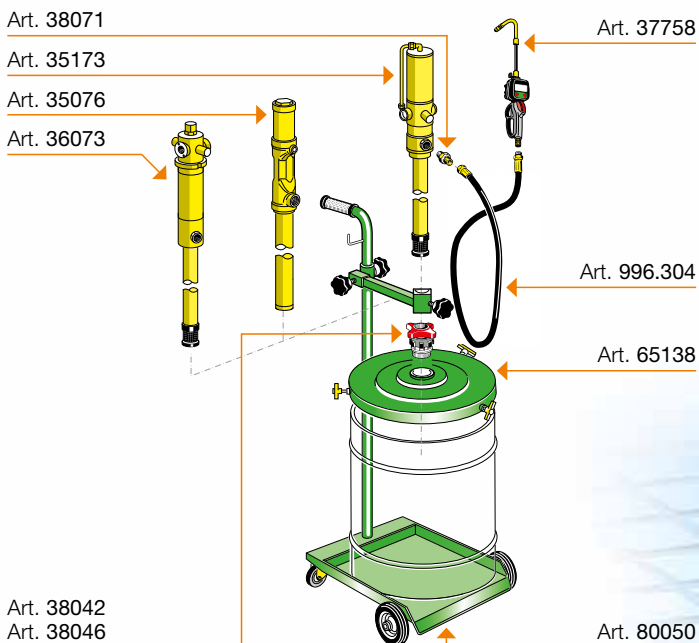

Engine oil filling up



Modular oil dispensing kit with hose reel

Oil dispensing system with pump applied on a drum or tank, equipped with open or enclosed swivelling hose reel series 420/440 and with digital metering gun. The kits are independent oil delivery station.

pump mounted on drum

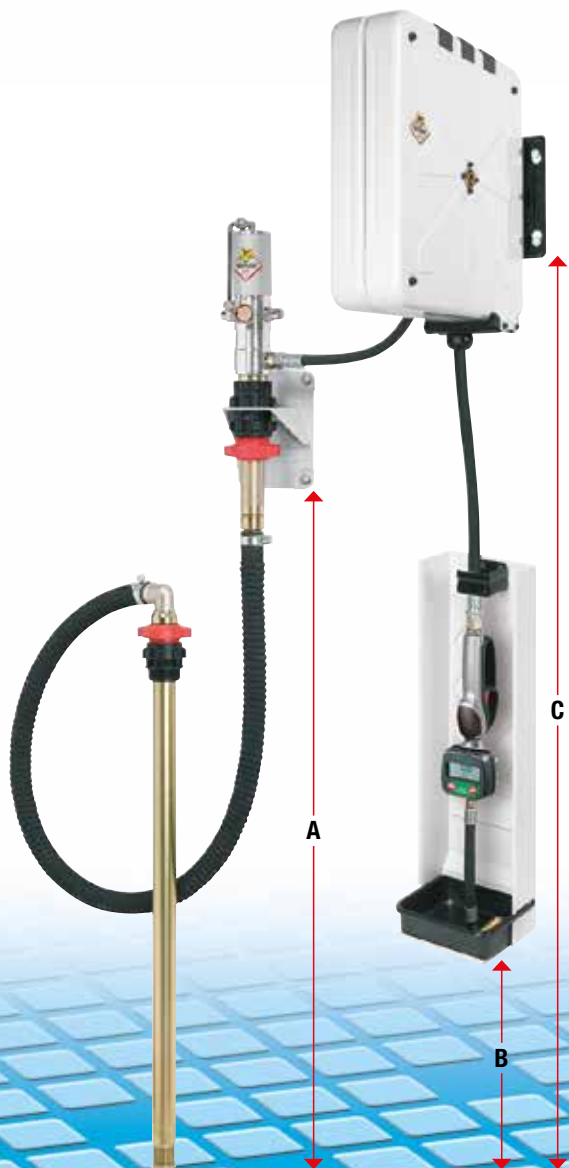

Article		35275	37675
Ratio		3:1	5:1
Flow rate	l/min	14	18
Pump	Art.	35194	36094
Hose reel	Art.	8420.401	8420.401
Bung adaptor	Art.	38042	38042
Wall bracket	Art.	-	-
Nipple	Art.	38071	38071
Digital metering gun	Art.	37758	37758
Flexible suction tube	Art.	-	-
Rigid suction tube	Art.	-	-
Drip-tray	Art.	88630	88630
Packing	N° - m³	4 - 0,128	4 - 0,128
Weight	kg	30,1	31,1
Dimensions (A - B - C) cm		94 - 90 - 220	94 - 90 - 220

Art. 88630 Modular drip-tray.

Equipped with hook for gun and removable drip-tray. Applied under the hose reel, it is a handy holder for the delivery gun. Essential for a clean and orderly workplace.

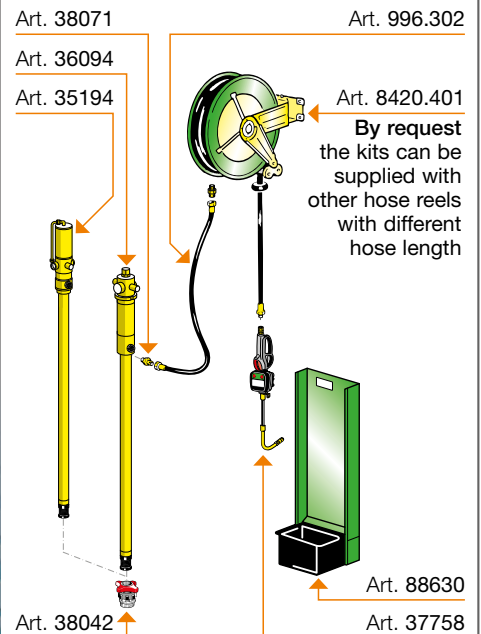

pump mounted on drum

wall mounted pump



35276

37676

35280

37680

35281

37679

3:1

5:1

3:1

5:1

3:1

5:1

14

18

14

18

14

18

35194

36094

35160

36060

35160

36060

8440.401

8440.401

8420.401

8420.401

8440.401

8440.401

38042

38042

38042

38042

38042

38042

-

-

38043

38043

38043

38043

38071

38071

38071

38071

38071

38071

37758

37758

37758

37758

37758

37758

-

-

38026

38026

38026

38026

-

-

38027

38027

38027

38027

88630

88630

88630

88630

88630

88630

4 - 0,130

4 - 0,130

4 - 0,130

4 - 0,130

4 - 0,135

4 - 0,135

37,1

38,1

38,5

39,5

45

45

94 - 90 - 220

94 - 90 - 220

170 - 90 - 220

170 - 90 - 220

170 - 90 - 220

170 - 90 - 220

Art. 38071

Art. 996.302

Art. 36094

Art. 35194

Art. 8440.401

By request the kits can be supplied with other hose reels with different hose length

Art. 88630

Art. 37758

Art. 38042

Art. 38071

Art. 36060

Art. 35160

Art. 38026

Art. 38027

Art. 38042

Art. 8420.401

Art. 8440.401

By request the kits can be supplied with other hose reels with different hose length

Art. 37758

Art. 88630

Art. 996.302

Art. 38043



Kit for DISPENSING from tank

Oil dispensing kit from IBC tank, equipped with wall mounted pump or tank mounted pump.

Kits with wall mounted pump can be connected with centralized lube piping or with an hose reel or a delivery hose. They are equipped with the accessories for air and oil connections. Kits with tank mounted pump are provided with hose reel and digital metering gun.



Note: the tank is not part of the kit

Article		35330	36330
Ratio		3:1	5:1
Flow rate	l/min	14	18
Pump	Art.	35160	36060
Pump support bracket	Art.	38043	38043
Support bracket drip-tray	Art.	-	-
Bung adaptor	Art.	33434	33434
Flexible suction tube	Art.	38026	38026
Rigid suction tube	Art.	38055	38055
Air hose connection	Art.	993.201	993.201
Oil hose connection	Art.	996.301	996.301
Cock	Art.	38210	38210
Nipple	Art.	38071	38071
Air regulator	Art.	37812	37812
Hose reel	Art.	-	-
Digital metering gun	Art.	-	-
Drip-tray	Art.	-	-
Packing	N° - m³	2 - 0,040	2 - 0,040
Weight	kg	15	15
Support width (A)	cm	-	-

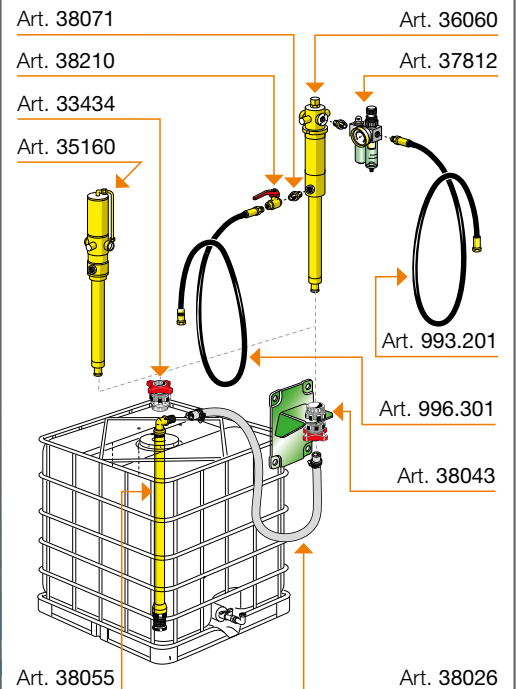

The possible solutions for equipping kits for tanks are many, due to the various shapes and sizes of the tanks (cube, rectangular, cylindrical) and the way in which the pump can be dipped (with suction tube connected to a cock on the bottom, etc.).

Therefore we recommend choosing the necessary components from among those indicated below, in order to make up the kit best suited to your needs.

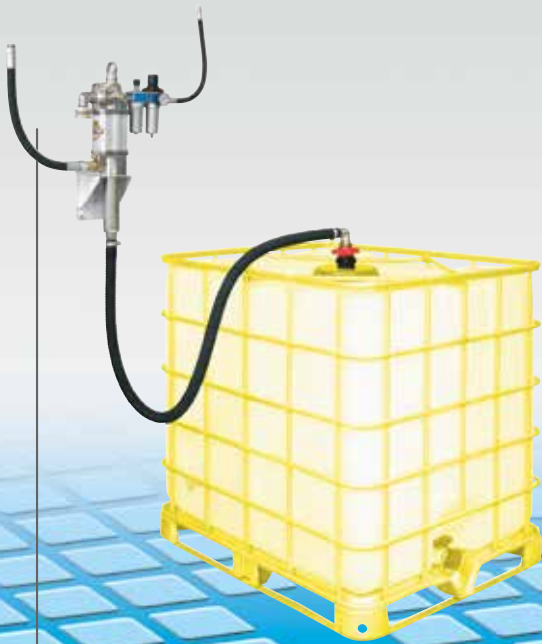
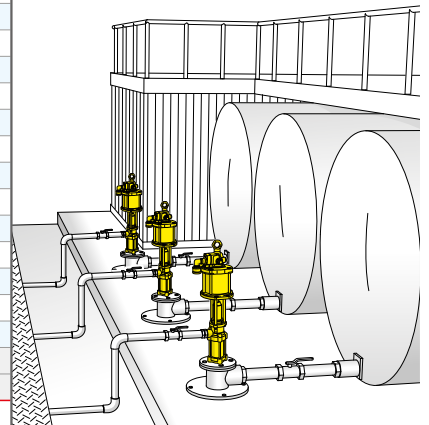
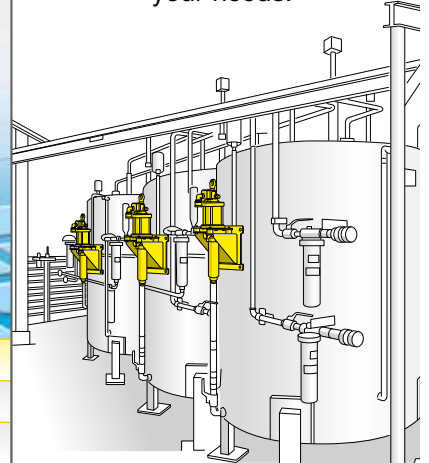

36340	36350	36610	36620
5:1	7:1	3:1	5:1
45	30	14	18
90C/51	90C/71	35163	36063
10/10	10/10	36602	36602
-	-	36604	36604
33434	33434	-	-
38026	38026	-	-
38055	38055	-	-
996.301	996.301	-	-
998.501	998.501	-	-
38211	38211	-	-
33119	33119	38071	38071
37817	37817	-	-
-	-	8430.401	8430.401
-	-	37758	37758
-	-	88630	88630
2 - 0,120	2 - 0,120	4 - 0,250	4 - 0,250
23	22	48	49
-	-	100	100

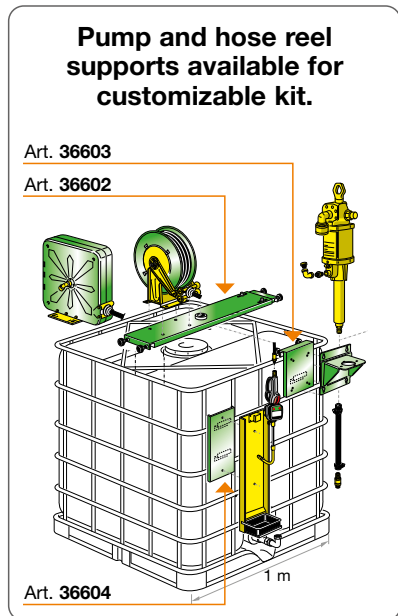
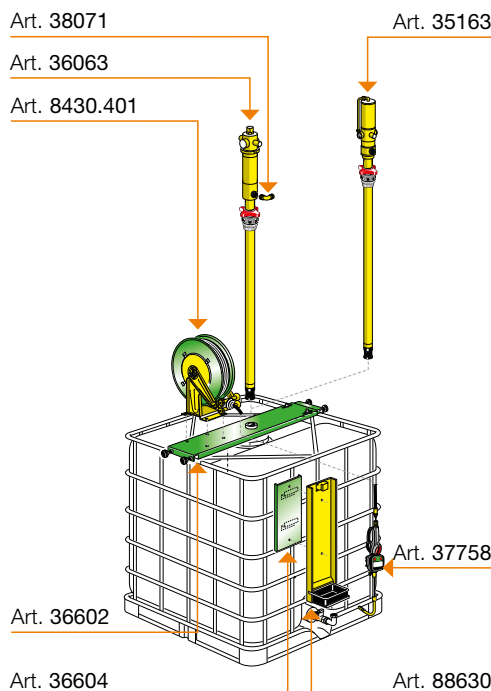
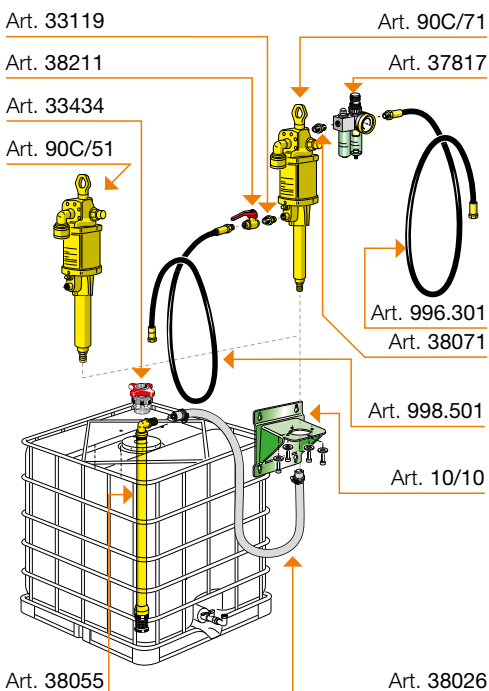



Modular kit for TRANSFER or EMPTYING oil, waste oil and similar

Wall-mounted transfer kit. A practical solution for draining movable equipment, waste oil suction/drainers by means of connection with quick-coupling valve. Wall application enables connection to a fixed system for discharging the sucked liquid directly into the storage tank.

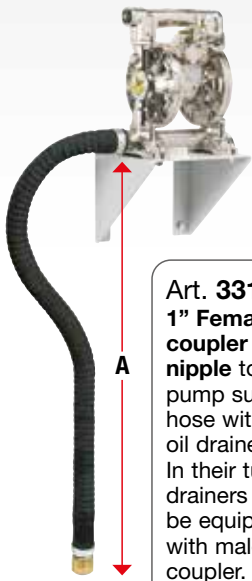

Art. 33134
1" Female quick coupler and nipple to connect pump suction hose with waste oil drainers. In their turn drainers must be equipped with male quick coupler.

Article with seals in	Viton®		33125
Article with seals in	NBR	33550	
Ratio		1:1	1:1
Flow rate	l/min	70	23
Pump	Art.	33/2011NHHV2	33070
Flexible suction tube 2 m	Art.	38026	38026
Air inlet flow regulator	Art.	37803	37803
Wall bracket	Art.	33590	33115
Packing	N° - m ³	1 - 0,030	1 - 0,029
Weight	kg	14	8,4
Distance (A)	cm	150	150

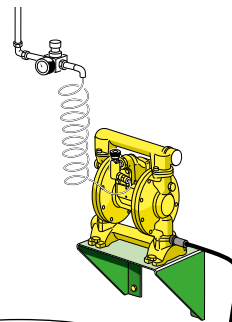

1 Pit waste oil drainer

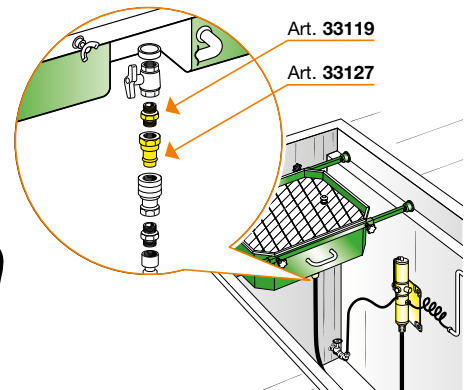

2 Floor waste oil drainer

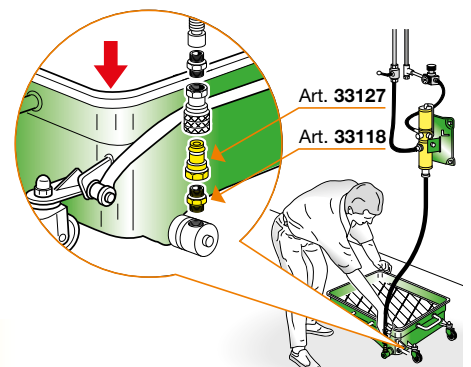

To connect waste oil drainers with above mentioned emptying kit it is necessary to mount a male quick coupler. Depending on the kind of waste oil drainers (standard, for pit or floor mounted) a different nipple must be used as shown in the examples (Pic. 1 - 2 - 3).

3 Standard waste oil drainer



Modular TRANSFER kit

transfer kit

Oil dispensing system with wall mounted or drum mounted pump.
 Kits with wall mounted pump can be connected with centralized lube piping or with an hose reel or a delivery hose.
 Kits with tank mounted pump are provided with hose reel and digital metering gun.
 The rigid suction tube can be lengthened by means of modular elements (refer to page 112 - 113) for adapting to the height of the tanks.



Article with seals in	Viton®	35284			35290		
Article with seals in	NBR		35285	37685		35293	35296
Ratio		3:1	3:1	5:1	3:1	3:1	5:1
Flow rate	l/min	20	14	18	20	14	18
Pump	Art.	35060	35160	36060	35094	35194	36094
Delivery hose	Art.	-	-	-	996.304	996.304	996.304
Connection hose	Art.	-	-	-	993.201	993.201	993.201
Flexible suction tube	Art.	38026	38026	38026	-	-	-
Rigid suction tube	Art.	38027	38027	38027	-	-	-
Nipple	Art.	-	-	-	38071	38071	38071
Pressure regulator	Art.	-	-	-	37801	37801	37801
Digital metering gun	Art.	-	-	-	37758	37758	37758
Bung adaptor	Art.	38042	38042	38042	38046	38042	38042
Wall bracket	Art.	38047	38043	38043	-	-	-
Packing	N° - m³	1 - 0,029	1 - 0,029	1 - 0,029	2 - 0,070	2 - 0,085	2 - 0,085
Weight	kg	11,4	11,4	11,9	14	13,5	13,5
Distance (A)	cm	150	150	150	-	-	-

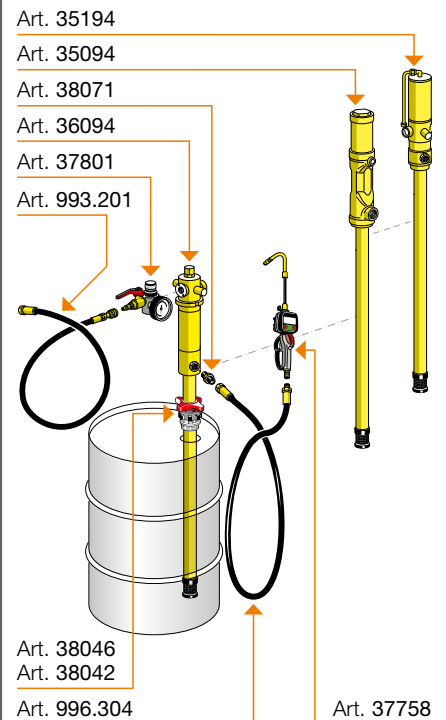
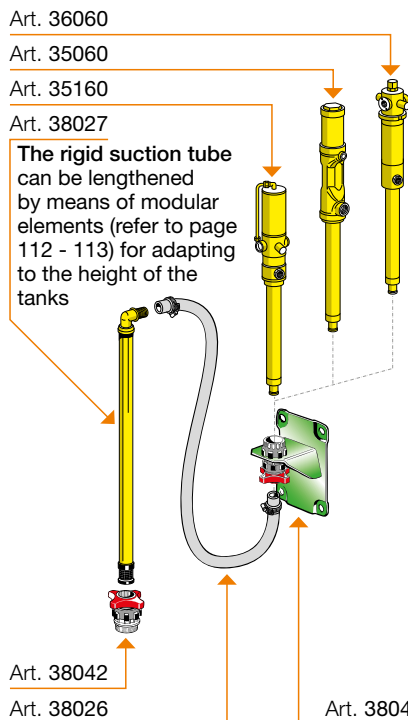
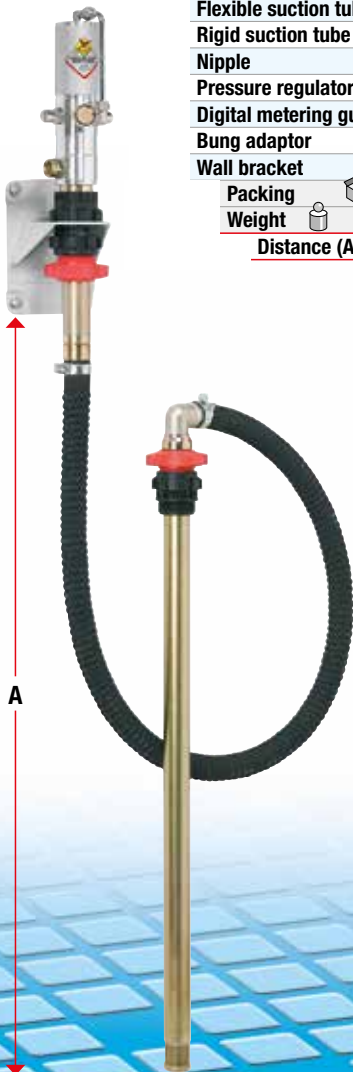



Oil BAR

wall-mounted

Oil bar ideal for dispensing engine oil, gear oil, antifreeze and similar liquids. It offers the availability of to 3 different types of oil. Quick and easy drawing of oil with possibility of controlling the quantity by means of the digital litre-counter available on request. Tap with double **valve** and **antisplash filter** to guarantee delivery while preventing sprays caused by possible air bubbles in the system. Closing is automatic when the lever is released. Equipped with an easy to clean, removable drip-catcher tray and sturdy support grid.



Article		37690	37689	37688	37691	37687	37686
Tap for oil bar	Art.	37692 x 1	37692 x 2	37692 x 3	37692 x 1	37692 x 2	37692 x 3
Digital litre-counter kit	Art.	-	-	-	37830 x 1	37830 x 2	37830 x 3
Packing	Art. N° - m ³	1 - 0,136	1 - 0,136	1 - 0,136	1 - 0,136	1 - 0,136	1 - 0,136
Weight	kg	23,8	25	26,2	25	26,5	28
Dimensions (A - B - C - D)	cm	67 - 43 - 56 - 46	67 - 43 - 56 - 46	67 - 43 - 56 - 46	67 - 43 - 56 - 46	67 - 43 - 56 - 46	67 - 43 - 56 - 46

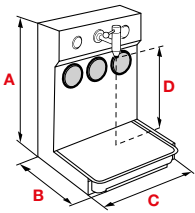

Note: a max of 3 taps and 3 digital litre-counter kits can be fitted on the oil bar

Kit feeding pump

Art. 37695
Kit with drum pump
for feeding oil bar,
equipped with:

- Art. 35194 pump
- **R 3:1 - 14 l/min**
- Art. 38042 bung adaptor
- Art. 996.304 hose 1/2" 4m
- elbow M 1/2" x M 1/2"
- nipple M 1/2" x F 1/2"

Art. 33501
Kit with drum pump for
feeding oil bar, equipped
with:

- Art. 33500 diaphragm pump R 1:1 - 70 l/min
- Art. 33434 bung adaptor
- Art. 996.304 tube 1/2" 4m
- Art. 33118 nipple M 3/4" x M 1/2"
- elbow F 1/2" x M 1/2"
- nipple M 1/2" x F 1/2"

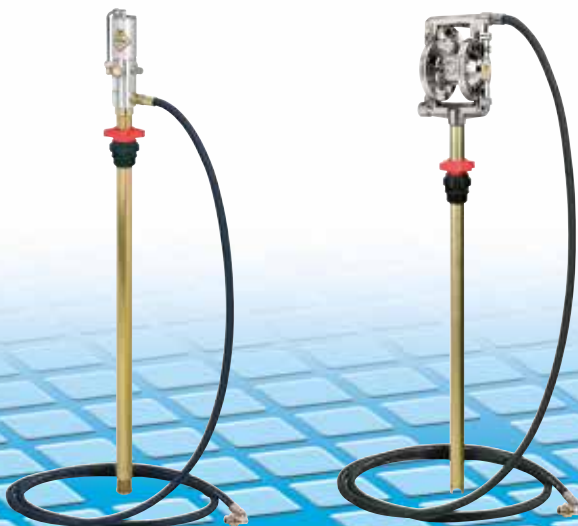

Example of installation

Example of installation with hose.

Example of installation of an oil bar with three service taps connected by hoses to the feeder pumps. This type of connection is only recommended for short distances. After the air is connected to the pump, by operating the tap handle, it will always be ready to use.

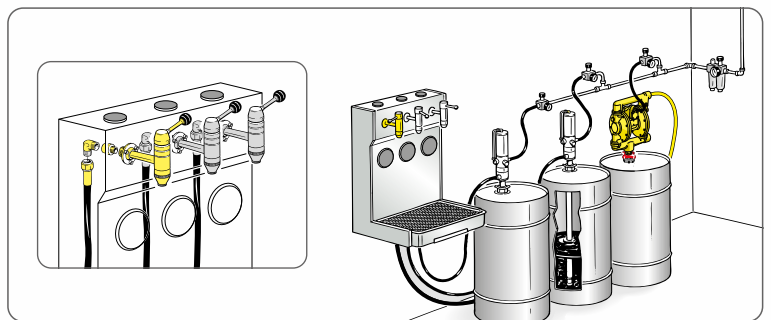

Example of installation to fixed system.

Example of installation to a fixed system with the oil bar connected to a centralized system by means of a 1 m hose.

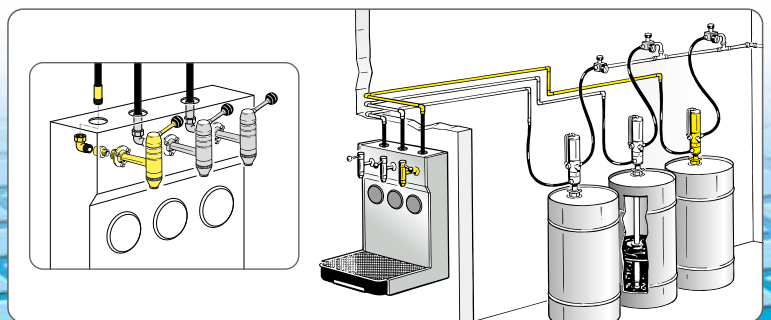



Drum oil BAR

Drum oil bar.
Ideal for dispensing oil and antifreeze liquid.
 The delivery tap is connected directly to the feed pump. Very compact, it enables quick filling of jugs or other small containers.



Article		37697	37698
Ratio		3:1	3:1
Flow rate	l/min	14	14
Pump	Art.	35194	35194
Tap for oil bar	Art.	37683	37683
Drip-catcher tray	Art.	37699	-
Bung adaptor	Art.	38042	38042
Packing	N° - m ³	2 - 0,034	2 - 0,025
Weight	kg	12	9,5
Dimensions (A-B-C)	cm	28,5 - 94 - 4,2	28,5 - 94 - 4,2

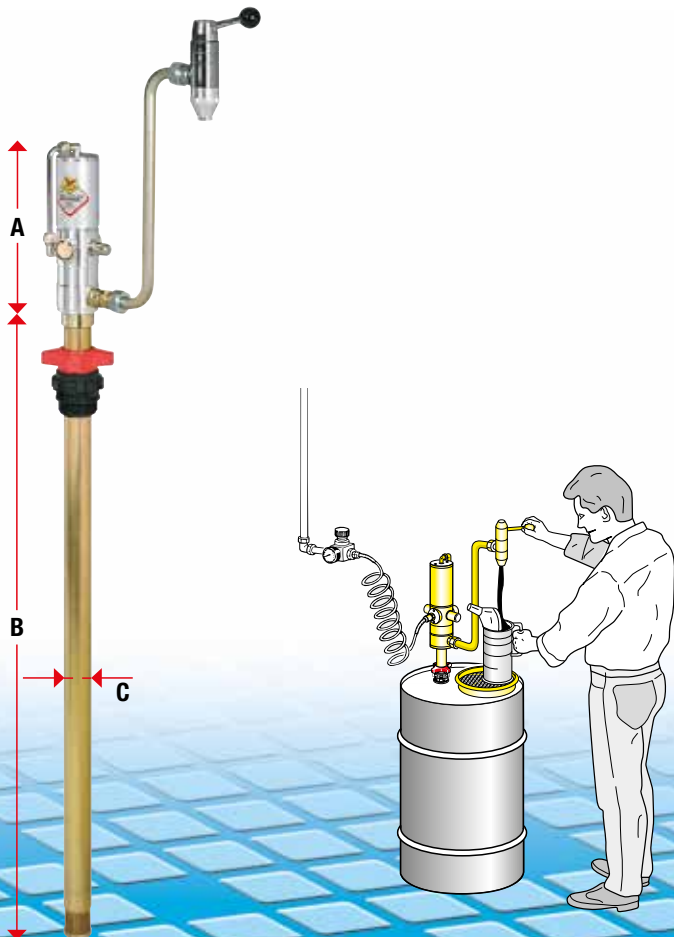

OIL BAR ACCESSORIES

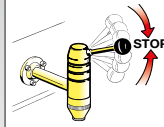
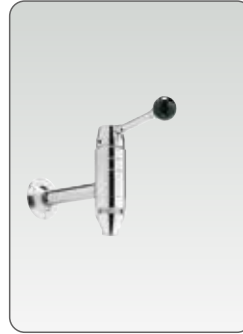

Art. 37692
Double valve tap with antisplash filter for oil bar inlet connection
 F 1/2" + M 3/4"

Note: both articles guarantee maximum delivery while preventing sprays caused by possible air bubbles in the system. Closing is automatic upon releasing the lever

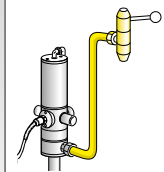

Art. 37683
Oil tap with pump connection, equipped with:
 - Art. 37681 tap for oil bar
 - Art. 37682 pump
 - oil bar tap connection tube

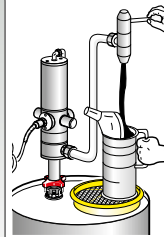

Art. 37699
Drip-catcher tray

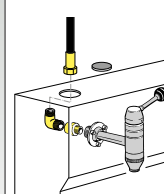

Art. 37693
Kit for connecting oil bar to fixed system, equipped with:
 - Art. 996.301 tube M 1/2" x F 1/2" - 1 m
 - elbow M 1/2" x M 1/2"
 - nipple M 1/2" x F 1/2"

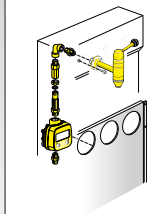

Art. 37830
Digital litre-counter kit for oil bar, equipped with:
 - Art. 37780 digital litre-counter
 - connection unions
 - connections M 1/2" x F 1/2"
 - not type-approved for public use



Art. 38102
2-litre jug

Art. 38105
5-litre jug

* articles not manufactured by us



DIGITAL Meter

Flow rate **35** l/min

Flow rate **70** l/min

Flow rate **40** l/min

RAASM's digital meters, besides gauging the liquid delivered, can show instant flow rates, provide a reset total and allow the setting of different units of measurement.

RAASM's digital meters are suitable for a wide variety of fluids, from low to medium to high viscosities, including lubricants, diesel fuel, antifreeze, window wash liquid and other fluids compatible with the material of the meter.



Not type-approved for public use

	oil and similar products	oil and similar products	antifreeze and windshield washing liquid
Article	37780	37781	37785
Flow rate l/min	35	70	40
Compatible fluids	Oil and similar products	Oil and similar products	Antifreeze and windshield washing liquid
Body's material	Aluminum	Aluminum	Aluminum with special surface treatment
Gear's material	POM	POM	PVDF
Inlet	F 1/2" BSP	F 3/4" BSP	F 1/2" BSP
Outlet	F 1/2" BSP	F 3/4" BSP	F 1/2" BSP
Max operating pressure bar	70	70	70
Burst pressure bar	± 200	± 200	± 200
Accuracy	± 0,3 %	± 0,5 %	± 0,5 %
Net weight kg	0,485	0,790	0,485
Packing N° - m ³	1 - 0,0015	1 - 0,0018	1 - 0,0015
Gross weight kg	0,85	1	0,85
Dimensions (A - B - C) mm	94 - 90 - 55	94 - 92 - 77	94 - 90 - 55



Diesel fuel version available. See specific documentation



TECHNICAL Characteristics

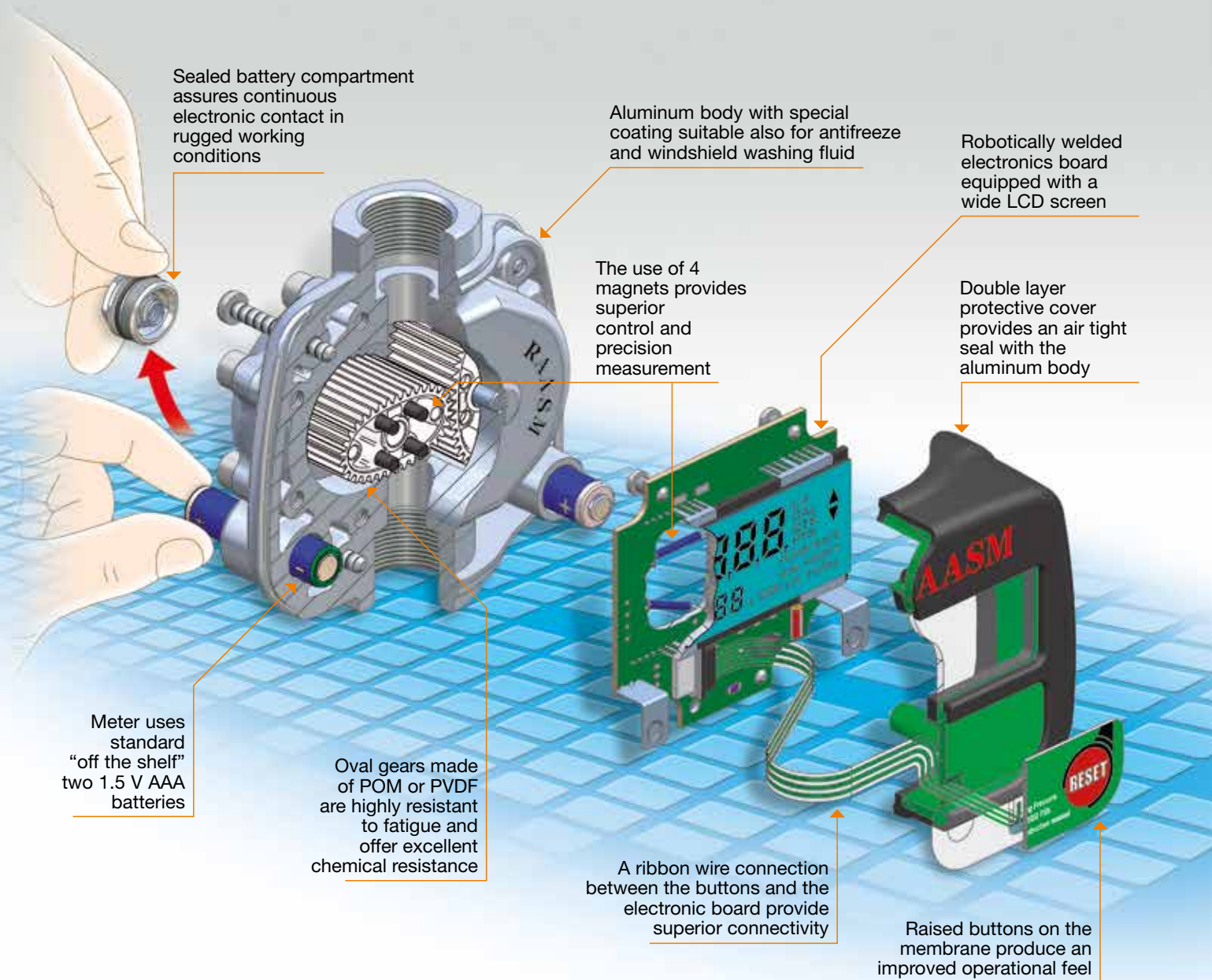

PERFORMANCE

- Precision $\pm 0,3 \%$
- Repeatability 0,2 %
- Pressure loss < 0,5 bar at max. flow rate



Series 1/2" 30 TP



Series 1/2" 40 AL



Series 1/2" 40 AP

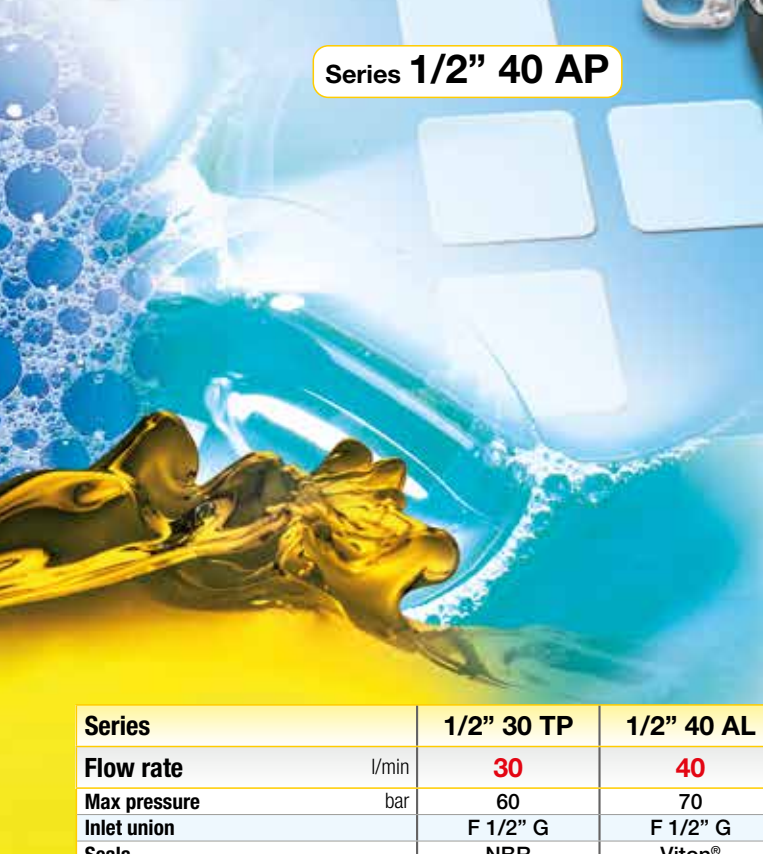

Series		1/2" 30 TP	1/2" 40 AL	1/2" 40 AP	1/2" 65 AP	3/4" 70 AP	3/4" 85 AP
Flow rate	l/min	30	40	40	65	70	85
Max pressure	bar	60	70	70	100	100	100
Inlet union		F 1/2" G	F 1/2" G	F 1/2" G	F 1/2" G	F 3/4" G	F 3/4" G
Seals		NBR	Viton®	Viton®	Viton®	Viton®	Viton®



**Gun for oil
and similar**

Series 1/2" 65 AP



Series 3/4" 70 AP



Series 3/4" 85 AP





GUN for oil and similar Series 1/2" - 30TP

Art. 38023

Grip in technopolymer for oil gun
equipped with F 1/2" inlet swivel joint, filter, F 3/8" outlet



Art. 33120

Oil gun equipped with
F 1/2" inlet swivel joint, filter, high flow rate rigid terminal

Art. 37730

Oil gun with digital litre-counter
Art. 37780 equipped with
F 1/2" inlet swivel joint, filter, high flow rate rigid terminal
- not type-approved for public use

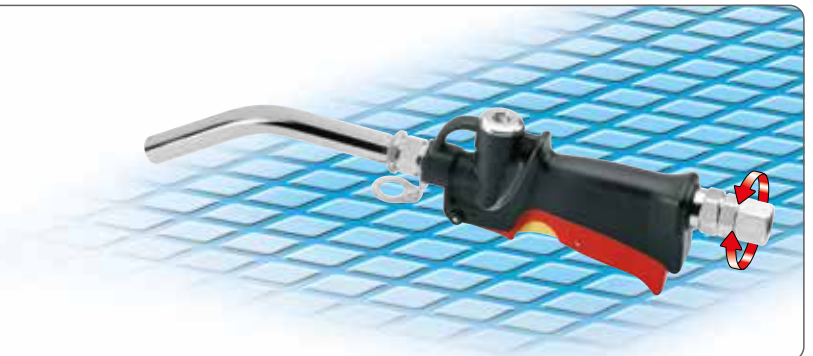

Art. 38024

Oil gun equipped with
F 1/2" inlet swivel joint, filter, rigid terminal
and semiautomatic drip-catcher nozzle ø 16 mm

Art. 37729

Oil gun with digital litre-counter
Art. 37780 equipped with
F 1/2" inlet swivel joint, filter, rigid terminal
and semiautomatic drip-catcher nozzle ø 16 mm
- not type-approved for public use



Art. 38025

Oil gun equipped with
F 1/2" inlet swivel joint, filter, flexible terminal
and semiautomatic drip-catcher nozzle ø 16 mm



Art. 37728

Oil gun with digital litre-counter
Art. 37780 equipped with
F 1/2" inlet swivel joint, filter, flexible terminal
and semiautomatic drip-catcher nozzle ø 16 mm
- not type-approved for public use





GUN

for oil and similar Series 1/2" - 40AL - 40AP

Art. 38020

Grip in aluminum for oil gun equipped with F 1/2" inlet swivel joint, filter, F 3/8" outlet

Art. 37740

Grip in aluminum for oil gun equipped with F 1/2" inlet swivel joint, filter, F 3/8" outlet, lever locking button



lever locking button



Art. 33121

Oil gun equipped with F 1/2" inlet swivel joint, filter, high flow rate rigid terminal

Art. 37743

Oil gun equipped with F 1/2" inlet swivel joint, filter, high flow rate rigid terminal, lever locking button

Art. 37760

Oil gun with digital litre-counter Art. 37780 equipped with F 1/2" inlet swivel joint, filter, high flow rate rigid terminal - not type-approved for public use



Art. 38021

Oil gun equipped with F 1/2" inlet swivel joint, filter, rigid terminal and semiautomatic drip-catcher nozzle ø 16 mm

Art. 37742

Oil gun equipped with F 1/2" inlet swivel joint, filter, rigid terminal, semiautomatic drip-catcher nozzle ø 16 mm and lever locking button

Art. 37759

Oil gun with digital litre-counter Art. 37780 equipped with F 1/2" inlet swivel joint, filter, rigid terminal, semiautomatic drip-catcher nozzle ø 16 mm - not type-approved for public use



Art. 38022

Oil gun equipped with 1/2" F inlet swivel joint, filter, flexible terminal and semiautomatic drip-catcher nozzle ø 16 mm

Art. 37741

Oil gun equipped with F 1/2" inlet swivel joint, filter, flexible terminal, semiautomatic drip-catcher nozzle ø 16 mm and lever locking button

Art. 37758

Oil gun with digital litre-counter Art. 37780 equipped with F 1/2" inlet swivel joint, filter, flexible terminal and semiautomatic drip-catcher nozzle ø 16 mm - not type-approved for public use

Art. 37786

Oil gun with digital litre-counter Art. 37780 equipped with F 1/2" inlet swivel joint, filter, flexible terminal, semiautomatic drip-catcher nozzle ø 16 mm and lever locking button - not type-approved for public use





GUN for oil and similar Series 1/2" - 65AP

Art. 37750

Grip in aluminum for oil gun equipped with F 1/2" inlet swivel joint, filter, F 1/2" outlet and lever locking button



Coloured caps supplied for all the range

lever locking button



Art. 33140

High flow rate oil gun equipped with F 1/2" inlet swivel joint, filter, high flow rate rigid terminal and lever locking button

Art. 37796

High flow rate oil gun with digital litre-counter Art. 37780 equipped with F 1/2" inlet swivel joint, filter, high flow rate rigid terminal and lever locking button
- not type-approved for public use



Art. 37752

Oil gun equipped with F 1/2" inlet swivel joint, filter, rigid terminal, semiautomatic drip-catcher nozzle ø 21 mm and lever locking button

Art. 37795

Oil gun with digital litre-counter Art. 37780 equipped with F 1/2" inlet swivel joint, filter, rigid terminal, semiautomatic drip-catcher nozzle ø 21 mm and lever locking button
- not type-approved for public use



Art. 37751

Oil gun equipped with F 1/2" inlet swivel joint, filter, flexible terminal, semiautomatic drip-catcher nozzle ø 21 mm and lever locking button

Art. 37794

Oil gun with digital litre-counter Art. 37780 equipped with F 1/2" inlet swivel joint, filter, flexible terminal, semiautomatic drip-catcher nozzle ø 21 mm and lever locking button, max pressure: 70 bar
- not type-approved for public use





GUN

for oil and similar Series 3/4" - 70AP

Art. 37775

High delivery oil grip in aluminum equipped with **F 3/4"** inlet swivel joint, filter, **F 1/2"** outlet and **lever locking button**



Coloured caps supplied for all the range

lever locking button



Art. 37778

High flow rate oil gun equipped with **F 3/4"** inlet swivel joint, filter, high flow rate rigid terminal and **lever locking button**

Art. 37799

High flow rate oil gun with digital litre-counter Art. 37781 equipped with **F 3/4"** inlet swivel joint, filter, high flow rate rigid terminal and **lever locking button**
- not type-approved for public use



Art. 37777

High flow rate oil gun equipped with **F 3/4"** inlet swivel joint, filter, rigid terminal 45°, semiautomatic drip-catcher nozzle ø 35 mm and **lever locking button**

Art. 37798

High flow rate oil gun with digital litre-counter Art. 37781 equipped with **F 3/4"** inlet swivel joint, filter, rigid terminal 45°, semiautomatic drip-catcher nozzle ø 35 mm and **lever locking button**
- not type-approved for public use



Art. 37776

High flow rate oil gun equipped with **F 3/4"** inlet swivel joint, filter, flexible terminal, semiautomatic drip-catcher nozzle ø 35 mm and **lever locking button**

Art. 37797

High flow rate oil gun with digital litre-counter Art. 37781 equipped with **F 3/4"** inlet swivel joint, filter, flexible terminal, semiautomatic drip-catcher nozzle ø 35 mm and **lever locking button**, max pressure: 70 bar
- not type-approved for public use





GUN

for oil and similar Series 3/4" - 85AP

Art. 33150

High delivery oil grip in aluminum equipped with **F 3/4"** inlet swivel joint, filter, **F 3/4"** outlet and **lever locking button**

lever locking button



Art. 33153

High delivery oil gun equipped with **F 3/4"** inlet swivel joint, filter, **lever locking button**, rigid terminal with free outlet

Art. 33148

High delivery oil gun with digital litre-counter Art. 37781 equipped with **F 3/4"** inlet swivel joint, filter, **lever locking button**, rigid terminal with free outlet
- not type-approved for public use



Art. 33152

High delivery oil gun equipped with **F 3/4"** inlet swivel joint, filter, **lever locking button**, rigid terminal and semiautomatic drip-catcher nozzle \varnothing 35 mm

Art. 33147

High delivery oil gun with digital litre-counter Art. 37781 equipped with **F 3/4"** inlet swivel joint, filter, **lever locking button**, rigid terminal and semiautomatic drip-catcher nozzle \varnothing 35 mm
- not type-approved for public use



Art. 33151

High delivery oil gun equipped with **F 3/4"** inlet swivel joint, filter, **lever locking button**, flexible terminal and semiautomatic drip-catcher nozzle \varnothing 35 mm

Art. 33146

High delivery oil gun with digital litre-counter Art. 37781 equipped with **F 3/4"** inlet swivel joint, filter, **lever locking button**, flexible terminal and semiautomatic drip-catcher nozzle \varnothing 35 mm, max pressure 70 bar
- not type-approved for public use

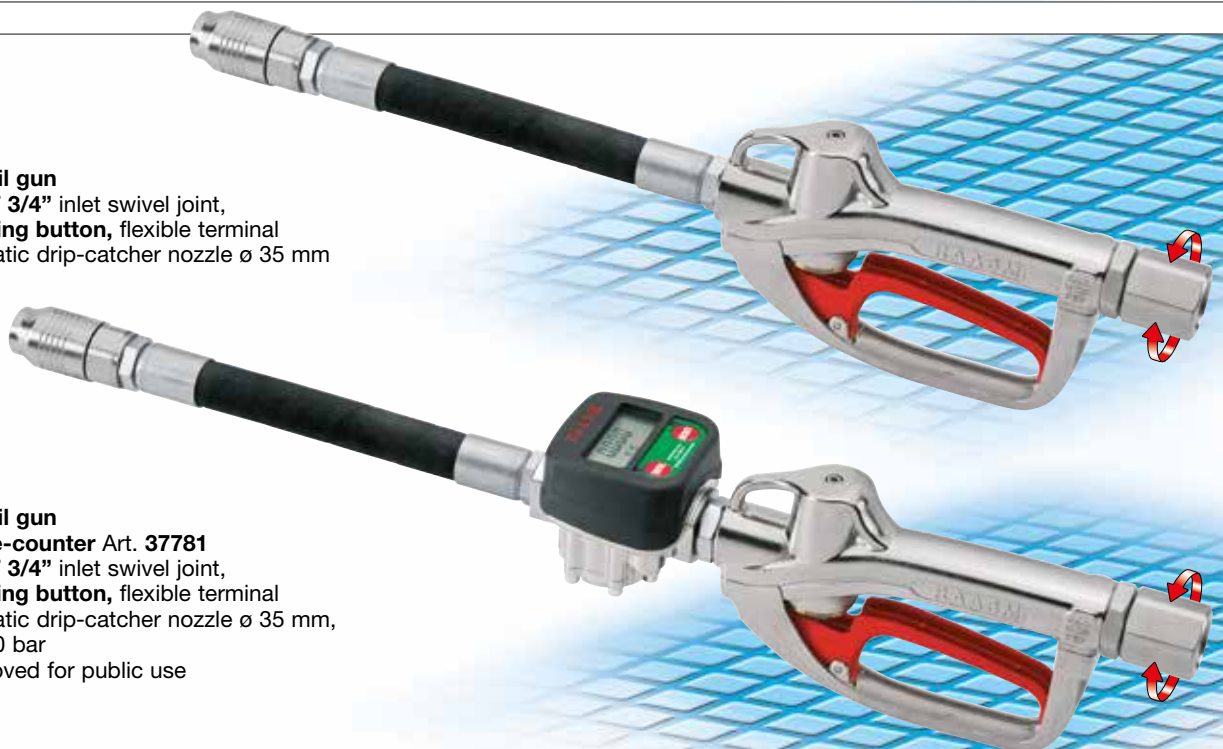



GUN

for windshield washing liquid and antifreeze

Art. 37785

Digital meter for windshield washing liquid and antifreeze, inlet and outlet F 1/2" BSP
- not type-approved for public use



Antifreeze gun Series 1/2" - 40AL

Art. 33121

Oil gun equipped with F 1/2" inlet swivel joint, filter, high flow rate rigid terminal

Art. 37764

Antifreeze gun with digital litre-counter Art. 37785 equipped with F 1/2" inlet swivel joint, filter, high flow rate rigid terminal
- not type-approved for public use

Art. 37762

Antifreeze gun with digital litre-counter Art. 37785 equipped with F 1/2" inlet swivel joint, filter, flexible terminal and semiautomatic drip-catcher nozzle \varnothing 16 mm
- not type-approved for public use

Art. 38022

Oil gun equipped with 1/2" F inlet swivel joint, filter, flexible terminal and semiautomatic drip-catcher nozzle \varnothing 16 mm



Windshield washing liquid gun Series 1/2" - 40AN

Art. 33445

Windshield washing liquid gun with oxidized aluminum grip equipped with F 1/2" inlet swivel joint, filter, high flow rate rigid terminal

Art. 33446

Windshield washing liquid gun with oxidized aluminum grip with digital litre-counter Art. 37785 equipped with F 1/2" inlet swivel joint, filter, high flow rate rigid terminal
- not type-approved for public use





Gun for oil and similar S. 1/2" - 30TP - 40AL - 40AP

Art. 38015
Semiautomatic
drip-catcher nozzle ø 10 mm

Art. 38016
Semiautomatic
drip-catcher nozzle ø 16 mm

Art. 38017
Semiautomatic
drip-catcher nozzle ø 8 mm



Art. 38010
Flexible terminal with
semiautomatic
drip-catcher nozzle ø 16 mm

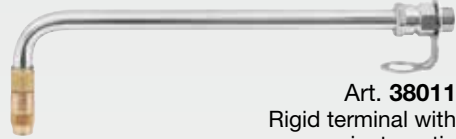

Art. 38011
Rigid terminal with
semiautomatic
drip-catcher nozzle ø 16 mm



Art. 38013
Rigid terminal 45°
with semiautomatic drip-catcher
nozzle ø 16 mm



Art. 38012
High delivery rigid
terminal with free outlet ø 20 mm



Art. 38023
Grip in technopolymer with
inlet swivel joint F 1/2"



Art. 38020
Grip in aluminum
with inlet swivel
joint F 1/2"



Art. 37740
Grip in aluminum with
F 1/2" inlet swivel joint and
lever locking button



Art. 38062
Swivel
joint for
oil gun,
M/F 1/2"



Art. 38018
Curved semiautomatic
drip-catcher ø 8 mm



Art. 38014
Flexible terminal with
semiautomatic
curved-drip-catcher nozzle ø 8 mm

Gun for oil and similar Series 1/2" - 65AP

Art. 38034
Semiautomatic
drip-catcher nozzle ø 21 mm

Art. 38035
Semiautomatic
drip-catcher nozzle ø 27 mm

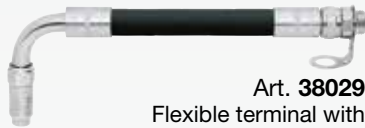

Art. 38029
Flexible terminal with
semiautomatic
drip-catcher nozzle ø 21 mm



Art. 38030
Rigid terminal with
semiautomatic
drip-catcher nozzle ø 21 mm



Art. 38031
Rigid terminal 45°
with semiautomatic
drip-catcher nozzle ø 21 mm



Art. 38032
High delivery rigid
terminal with free outlet ø 20 mm



Art. 37750
Grip in aluminum
with inlet swivel joint F 1/2"
and lever locking button



Art. 38063
Swivel
joint for
oil gun,
M/F 1/2"



Gun for oil and similar Series 3/4" - 70AP - 85AP



Art. 38040
High delivery
semiautomatic
drip-catcher nozzle
ø 35 mm

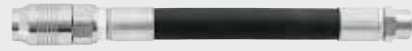

Art. 38037
High delivery
flexible terminal
with semiautomatic
drip-catcher nozzle ø 35 mm



Art. 38038
High delivery rigid
terminal 45° with
semiautomatic drip-catcher
nozzle ø 35 mm



Art. 38039
High delivery rigid
terminal with
free outlet ø 26 mm



Art. 37775
Grip in aluminum with
inlet swivel joint
F 3/4" and lever
locking button



Art. 33150
Grip in aluminum
with inlet swivel
joint F 3/4" and level
locking button



Art. 38066
Swivel
joint for
oil gun,
M 1/2" x F 3/4"



Art. 38065
Swivel joint for oil
gun, high delivery,
inlet M/F 3/4"

High delivery grip Series 3/4"

Example of used 3/4" oil gun with quick coupler for tank refilling.

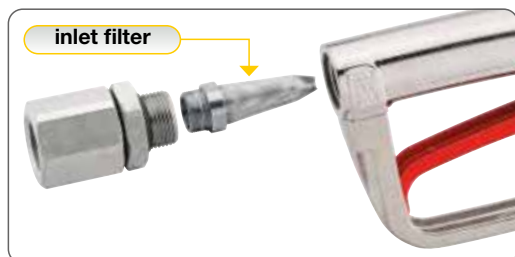
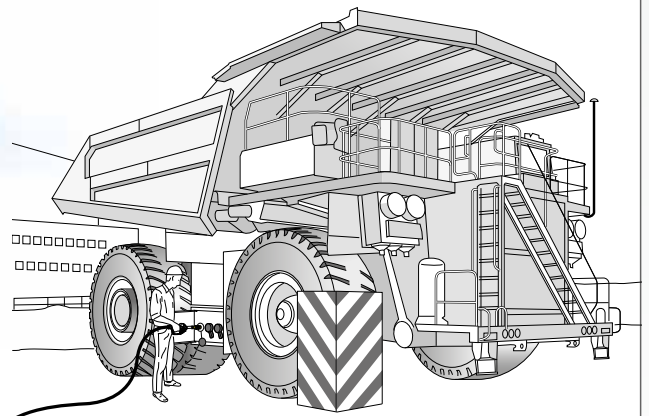

Inlet filter supplied with all our oil, antifreeze, windshield liquid delivery gun.



Accessories

digital meters and volumetric guns



- Art. 37704**
Digital dispensing oil gun with preselection,
equipped with:
- inlet swivel joint **F 1/2"**
 - flexible terminal
 - semiautomatic nozzle \varnothing 16 mm

* not type-approved for public use
* articles not manufactured by us



- Art. 37701**
Mechanical litre-counter (weight 1 kg) **for oil,**
equipped with:
- connection **F 1/2" x F 1/2"**
 - indicator 0-10 litres

* not type-approved for public use
* articles not manufactured by us



- Art. 37703**
Oil gun with mechanical litre-counter (Art. 37701),
equipped with:
- inlet swivel joint **F 1/2"**
 - flexible terminal
 - semiautomatic nozzle \varnothing 16 mm

* not type-approved for public use
* articles not manufactured by us



- Art. 33122**
High delivery oil gun for transfer,
equipped with:
- **F 3/4"** inlet swivel joint (max 8 bar)
 - rigid terminal with free outlet
- Ideal for high deliveries in transferring oil, waste oil and antifreeze liquid

Note: it is advisable to use it with hose 3/4" (Art. 997.505) and with pumps R 1:1 (max 8 bar)

* articles not manufactured by us



Accessories for oil pumps



Art. 38046
Bung adaptor
ø 32 mm, with double body
for pumps with suction tube,
series 500

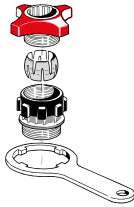

Art. 33434
Bung adaptor
ø 34 mm, with double body
for pumps with suction tube,
series 600

Art. 38042
Bung adaptor
ø 42 mm, with double body
for pumps with suction tube,
series 600 e 650

Art. 38044
Bung adaptor
ø 38 mm, with double body
for pumps manual double
acting oil pumps

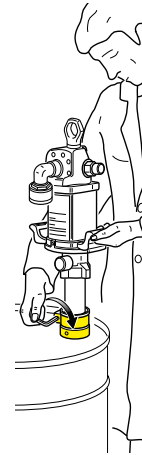

Art. 38051
Bung adaptor
ø 50 mm, for pumps
with suction tube,
series 500

Art. 10/14
Bung adaptor
ø 45 mm for industrial
pumps with suction tube,
series 900 e 1200

Art. 10/15
Bung adaptor
ø 53 mm for industrial
pumps with suction tube,
series 900 e 1200

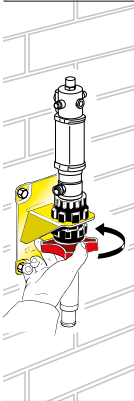

Art. 38047
Wall bracket ø 32 mm
with double body
for wall-mounting of pumps,
series 500

Art. 38043
Wall bracket ø 42 mm
with double body
for wall-mounting of pumps,
series 600 and 650

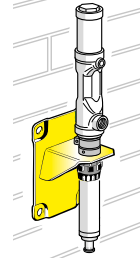

Art. 38052
Wall bracket ø 50 mm
with clamping system
with screw for
wall-mounting
of pumps,
series 500

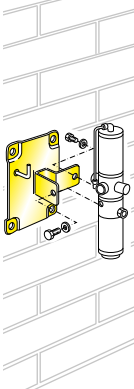

Art. 33115
Wall bracket in steel
for wall-mounting of
transfer pumps,
series 600 and 650

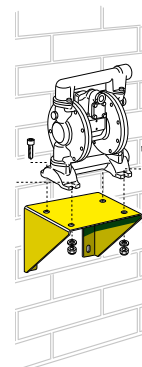

Art. 33590
**Wall bracket in painted
steel** for wall-mounting
of diaphragm pumps
1/2" and 3/4"

Art. 33591
**Wall bracket in painted
steel** for wall-mounting
of diaphragm pumps
1" and 1.1/4"

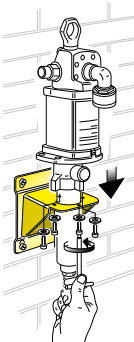

Art. 10/10
**Wall bracket in painted
steel** for wall-mounting
of integral and flanged
industrial pumps,
series 900 and 1200

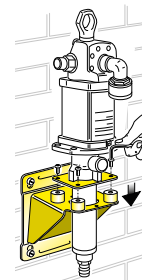

Art. 10/11
**Wall bracket in
painted steel**
with dampers for
wall-mounting of
integral and flanged
industrial pumps,
series 900 and 1200



Accessories for oil pumps

Union 2" F

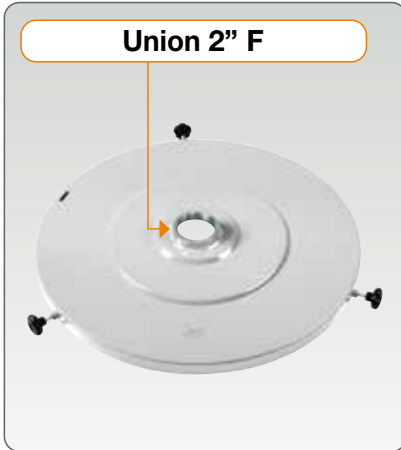

Drum cover with 2" F union suitable for standard bung adaptor

- Art. **65160** Drum cover ø 600 mm (drums ø external 550 - 600 mm)
- Art. **65142** Drum cover ø 420 mm (drums ø external 370 - 420 mm)
- Art. **65138** Drum cover ø 385 mm (drums ø external 340 - 385 mm)

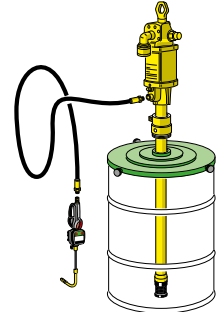

- Art. **88630**
Modular drip-tray.
Equipped with hook for gun and removable drip-tray. Applied under the hose reel, it is a handy holder for the delivery gun. Essential for a clean and orderly workplace

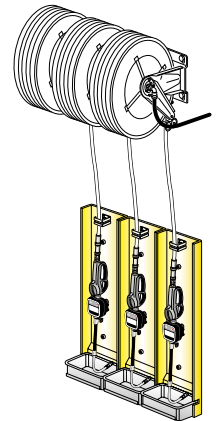

- Art. **33126**
Female quick connector
- thread F 3/4" G
- high pressure 250 bar

- Art. **33127**
Male quick connector
- thread F 3/4" G
- high pressure 250 bar

* articles not manufactured by us



- Art. **38069**
90° union
- 3/4" G - F/M

- Art. **38070**
90° union
- 1/2" G - F/M

* articles not manufactured by us



- Art. **33106** Nipple M 3/4" NPT x F 3/4" G
- Art. **33107** Nipple M 3/4" G x F 1" NPT
- Art. **33108** Nipple M 1" G x F 3/4" NPT
- Art. **33109** Nipple M 1" G x F 1" NPT
- Art. **38075** Nipple M 1/2" G x F 1/2" NPT
- Art. **38076** Nipple M 1/2" NPT x F 1/2" G
- Art. **38077** Nipple M 3/8" NPT x F 3/8" G
- Art. **38078** Nipple M 3/8" G x F 3/8" NPT
- Art. **38079** Nipple M 1/2" NPT x M 3/8" NPT
- Art. **33111** Nipple M 1.1/4" G x F 1.1/4" NPT
- Art. **33112** Nipple M 3/4" G x F 3/4" NPT
- Art. **33113** Nipple M 1/2" G x F 3/4" NPT

* articles not manufactured by us



- Art. **38071** Nipple M 1/2" G x M 1/2" G ●●
- Art. **38072** Nipple M 1/2" G x M 3/8" G ●
- Art. **38073** Nipple M 3/8" G x M 3/8" G ●●
- Art. **33114** Nipple M 1" G x M 1/2" G ●
- Art. **33116** Nipple M 1" G x M 1" G ●
- Art. **33117** Nipple M 3/4" G x M 3/4" G ●
- Art. **33118** Nipple M 1/2" G x M 3/4" G ●
- Art. **33119** Nipple M 1" G x M 3/4" G ●
- Art. **33275** Nipple M 1/2" G x F 3/4" G ●
- Art. **33276** Nipple M 3/4" G x F 1" G ●
- Art. **33277** Nipple M 3/4" G x F 1/2" G ●

●● tapered/cylindrical thread
● cylindrical/cylindrical thread



Accessories 4-way evacuation valve and flow regulator chamber



The 4-way evacuation valve is used for extraction and discharge of waste oil fluid hydraulic gear and engine oil and antifreeze

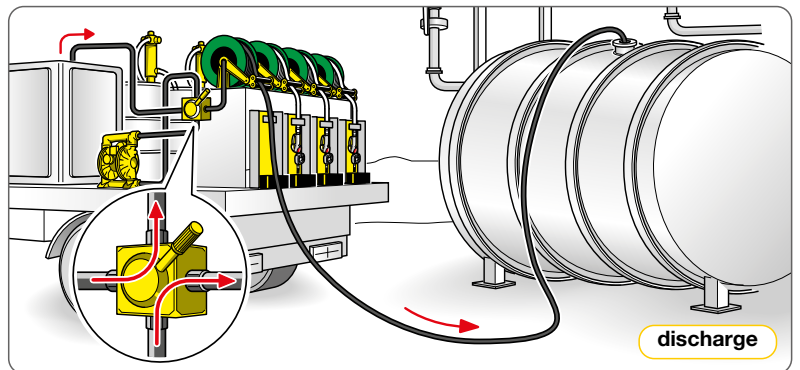
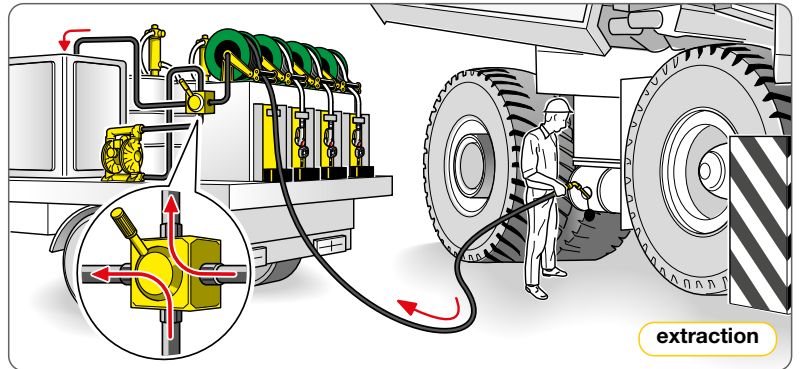

Art. 38130
4-way evacuation valve with connection F 3/4"G

Art. 38131
4-way evacuation valve with connection F 1"G

Art. 38132
4-way evacuation valve with connection F 1.1/2"G

Article	Seals	Connection	Pressure	Weight
38130	Viton®	F 3/4"	14 bar	3 kg
38131	Viton®	F 1"	14 bar	3 kg
38132	Viton®	F 1.1/2"	14 bar	3 kg



Art. 38097

Flow regulator chamber F 3/4" x F 3/4" equipped with:
 - one-way valve eliminates sudden pressure changes, ensuring a regular flow
 - suitable for R 1:1 - 3:1 - 5:1 pumps
 - max pressure 100 bar

Art. 38098

Flow regulator chamber F 3/4" x F 3/4" with air tank equipped with:
 - one-way valve eliminates sudden pressure changes, ensuring a regular flow
 - suitable for pumps till R 20:1
 - max pressure 100 bar

Pressure trend of oil pump outlet

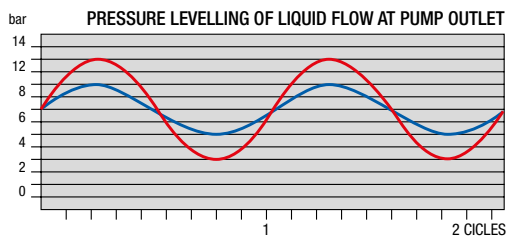

with pump R 3:1 - 8 bar
 ■ without chamber Art. 38097
 ■ with chamber Art. 38097

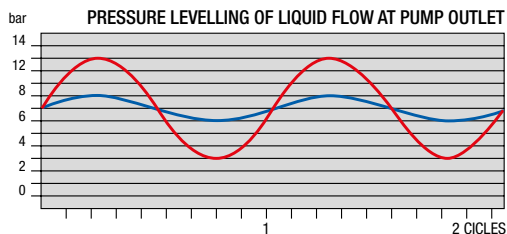

with pump R 3:1 - 8 bar
 ■ without chamber Art. 38098
 ■ with chamber Art. 38098

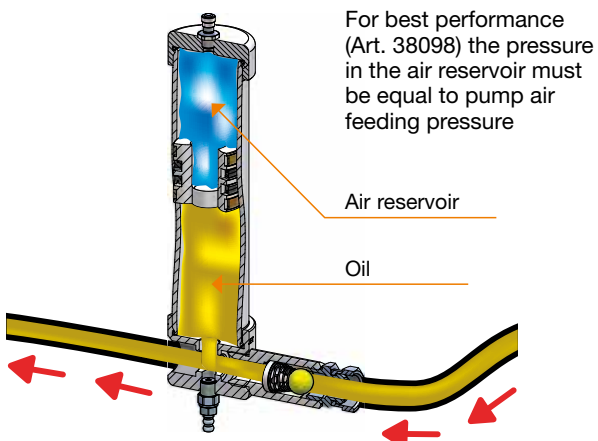



Accessories for oil pumps

*



Art. 38210

Art. 38211

Art. 38210
Ball cock F 1/2" x F 1/2"
total passage for system
- max pressure 70 bar

Art. 38211
Ball cock F 1" x F 1"
total passage for system
- max pressure 70 bar

* articles not manufactured by us

*



Art. 38095
"Y" filter in line F/F 1/2" for fitting on the outlet of pumps for oil and allied products, max pressure 100 bar

Art. 38096
"Y" filter in line F/F 1" for fitting on the outlet of pumps for oil and allied products, max pressure 100 bar

* articles not manufactured by us

*



Art. 38099
System overpressure control valve
- F 1/2" x F 1/2"
- Calibration 5 - 50 bar

Art. 38100
System overpressure control valve
- F 3/4" x F 3/4"
- Calibration 5 - 50 bar

* articles not manufactured by us

*



Art. 37812
Pressure regulator with condensate discharge filter, lubricator, pressure gauge and inlet-outlet connections F/F 1/4"

Art. 37817
Pressure regulator with condensate discharge filter, lubricator, pressure gauge and inlet-outlet connections F/F 1/2"

* articles not manufactured by us



Art. 38091
Check valve with connection for flexible hose 1.1/4" - thread 1"G - M to be fitted on the draining cock of tanks



Art. 38080
Hose holder ø 1.1/4" with **M 3/4" inlet connection**
Art. 38081
Hose holder ø 1.1/4" with **M 1" inlet connection**
Art. 38082
Hose holder ø 1.1/4" with **M 1.1/4" inlet connection**
Art. 38083
Stainless steel hose holder ø 3/4" with **M 1" inlet connection**



Art. 38026
Flexible suction tube ø 1.1/4" - 30 mm - length 2 m for wall-mounted pumps

Art. 38028
Flexible suction tube ø 1.1/4" - 30 mm - length 1 m for wall-mounted pumps



Art. 33426
Flexible suction tube ø 3/4" - length 2 m for wall-mounted s/steel pumps



Art. 993.201 **Hose M 1/4" x F 1/4"** - 1 m - 20 bar
Art. 993.202 **Hose M 1/4" x F 1/4"** - 2 m - 20 bar
Art. 996.301 **Hose M 1/2" x F 1/2"** - 1 m - 150 bar
Art. 996.302 **Hose F 1/2" x F 1/2"** - 2 m - 150 bar
Art. 996.304 **Hose M 1/2" x F 1/2"** - 4 m - 150 bar
Art. 997.3305 **Hose M 3/4" x F 3/4"** - 5 m - 100 bar
Art. 998.501 **Hose M 1" x F 1"** - 1 m - 150 bar
Art. 998.502 **Hose M 1" x F 1"** - 2 m - 150 bar



Accessories for oil pumps



Art. 38056

Flexible and rigid suction tube for wall mounted pump series 500 - 600 - 650 - 900 equipped with:

- Art. 38026 flexible suction tube 2 m - \varnothing 1.1/4"
- Art. 38027 rigid suction tube 940 mm
- Art. 38042 bung adaptor

Art. 38057

Flexible and rigid suction tube for wall mounted pump series 500 - 600 - 650 - 900 equipped with:

- Art. 38026 flexible suction tube 2 m - \varnothing 1.1/4"
- Art. 38055 rigid suction tube 1260 mm
- Art. 33434 bung adaptor

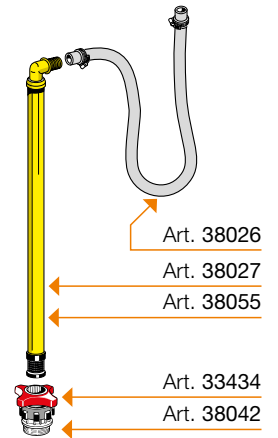

Art. 33583

Flexible and rigid suction tube for wall mounted diaphragm pump equipped with:

- Art. 38026 flexible suction tube 2 m - \varnothing 1.1/4"
- Art. 33581 rigid suction tube 940 mm - \varnothing 1.1/4"
- Art. 33434 bung adaptor

Art. 33585

Flexible and rigid suction tube for wall mounted diaphragm pump equipped with:

- Art. 38026 flexible suction tube da 2 m - \varnothing 1.1/4"
- Art. 33582 rigid suction tube 1240 mm
- Art. 33434 bung adaptor

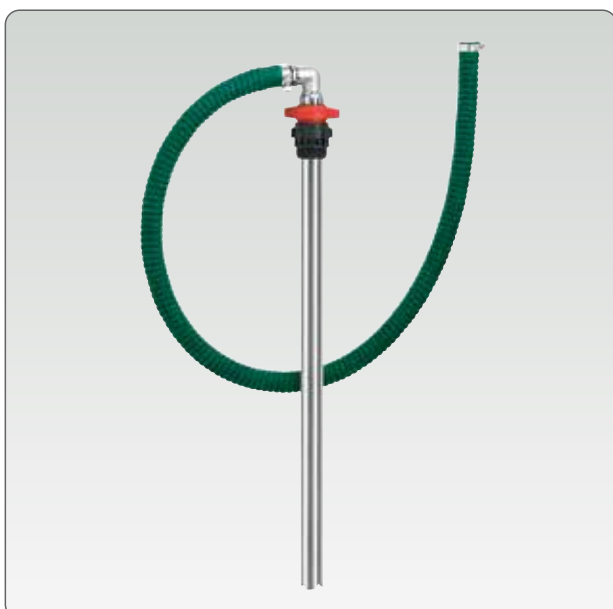
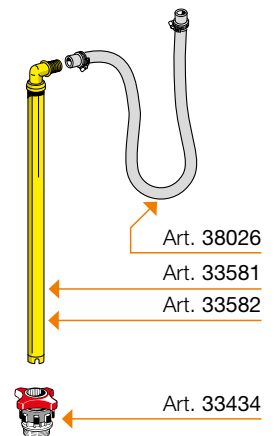

Art. 33424

Flexible and rigid suction tube for wall mounted pump series 600 INOX equipped with:

- Art. 33426 flexible suction tube 2 m - \varnothing 3/4"
- Art. 33427 stainless steel suction tube 940 mm - \varnothing 3/4"
- Art. 33434 bung adaptor

Art. 33425

Flexible and rigid suction tube for wall mounted pump series 600 INOX equipped with:

- Art. 33426 flexible suction tube 2 m - \varnothing 3/4"
- Art. 33428 stainless steel suction tube 1260 mm - \varnothing 3/4"
- Art. 33434 bung adaptor

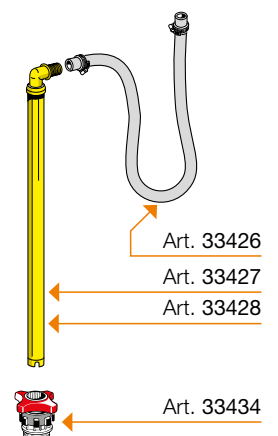



Accessories extensions 1" thread



Art. 38092

Top connector - thread F 1" x F 1"
allows to connect pump M 1" thread with
extensions M 1" thread

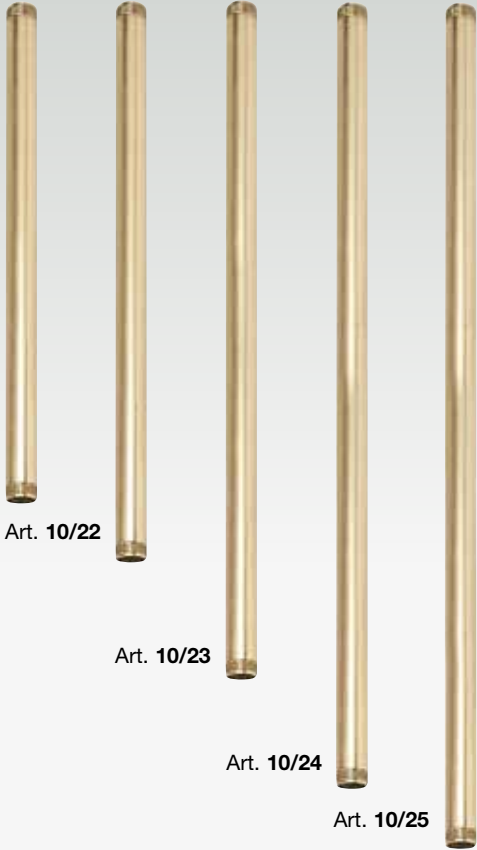

Art. 10/21

Art. 10/22

Art. 10/23

Art. 10/24

Art. 10/25

Art. 10/21

Extension ø 34 - thread M 1"G x M 1"G - 460 mm
- suitable for modular and extendable pumps with F 1" connection

Art. 10/22

Extension ø 34 - thread M 1"G x M 1"G - 660 mm
- suitable for modular and extendable pumps with F 1" connection

Art. 10/23

Extension ø 34 - thread M 1"G x M 1"G - 960 mm
- suitable for modular and extendable pumps with F 1" connection

Art. 10/24

Extension ø 34 - thread M 1"G x M 1"G - 1260 mm
- suitable for modular and extendable pumps with F 1" connection

Art. 10/25

Extension ø 34 - thread M 1"G x M 1"G - 1460 mm
- suitable for modular and extendable pumps with F 1" connection

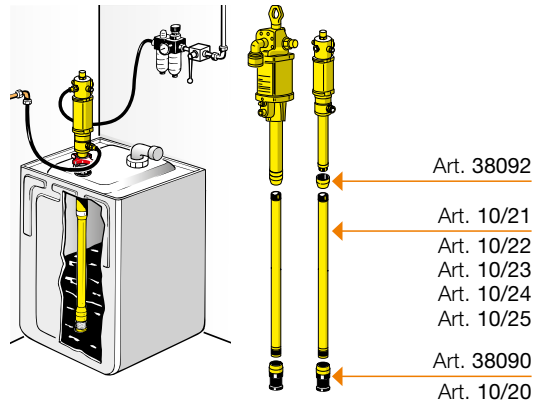

Art. 38090



Art. 10/20

Art. 38090

Foot valve with air eliminator - F 1" thread
suitable to fit ø 34 extensions M 1"G thread

Art. 10/20

Foot valve with filter - F 1" thread
suitable to fit ø 34 extensions M 1"G thread

Extendable pumps suction tube 1"

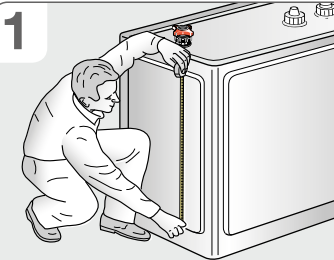

1 Obtain a water pipe (normally available on the market) ø 1" and thickness 2,5 mm

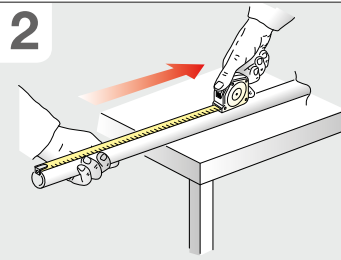

2 Cutting the length suitable for the container

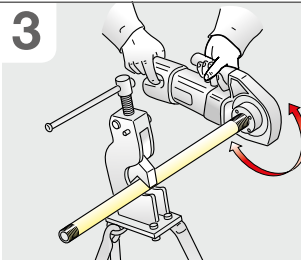

3 Thread the 2 ends with 1" gas Male

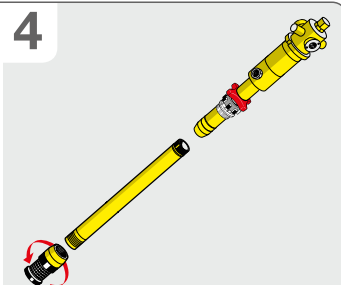

4 Screw the threaded pipe between the pump and the foot valve (Art. 10/20)

Note: apply a sealant to prevent air infiltration in the pumping phase or oil leaks during stops



Accessories extensions for customising pumps



Art. 38084
Top connector F 1"
for connection between
pump and extension

Art. 38085
Extension ø 32 mm
- 500 mm

Art. 38086
Connector to joint together
to extensions

Art. 38087
Extension ø 32 mm
- 200 mm

Art. 38088
Foot valve
complete with union and
filter

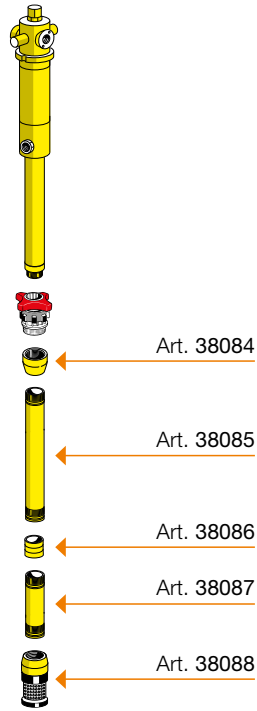

Art. 38089
**Differentiated union with
valve** for suction tubes
ø 42 mm with the foot
valve removed it enables
connection between the
suction tube and the modular
extensions

Art. 38093
Union for foot valve
it connects the modular
extension, added to
the suction tube, to the
previously removed foot
valve

Suction tube bottom connections

Extension of the rigid suction
tube for adapting to tank depth

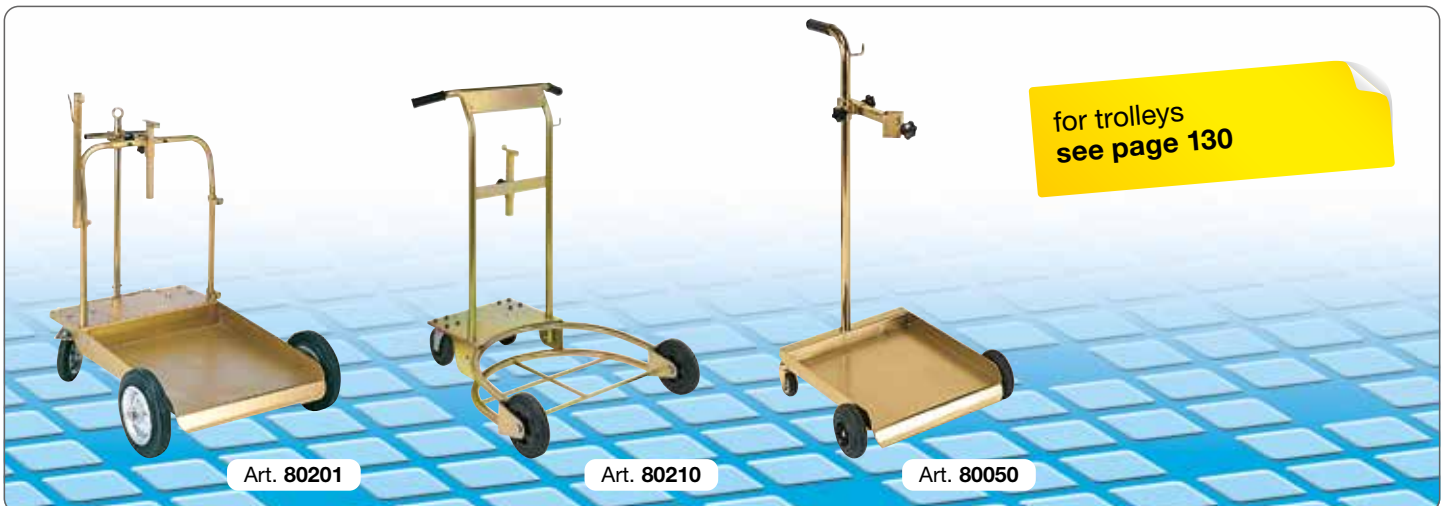
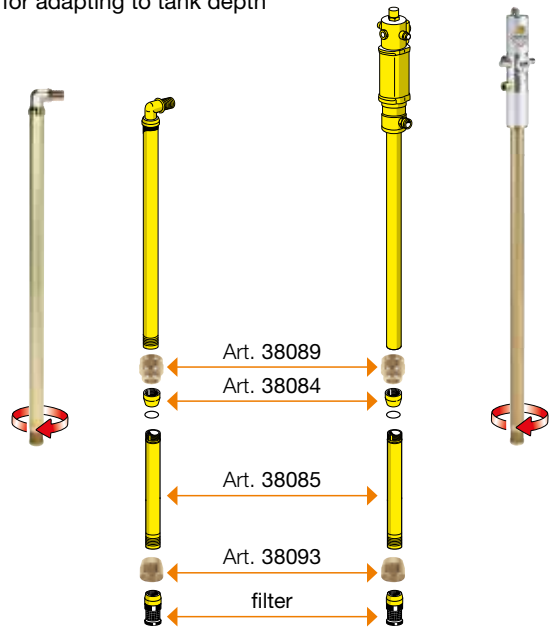

for trolleys
see page 130

Art. 80201

Art. 80210

Art. 80050



FLUIDS AND LUBRICATION EQUIPMENT



Grease dispensing pumps

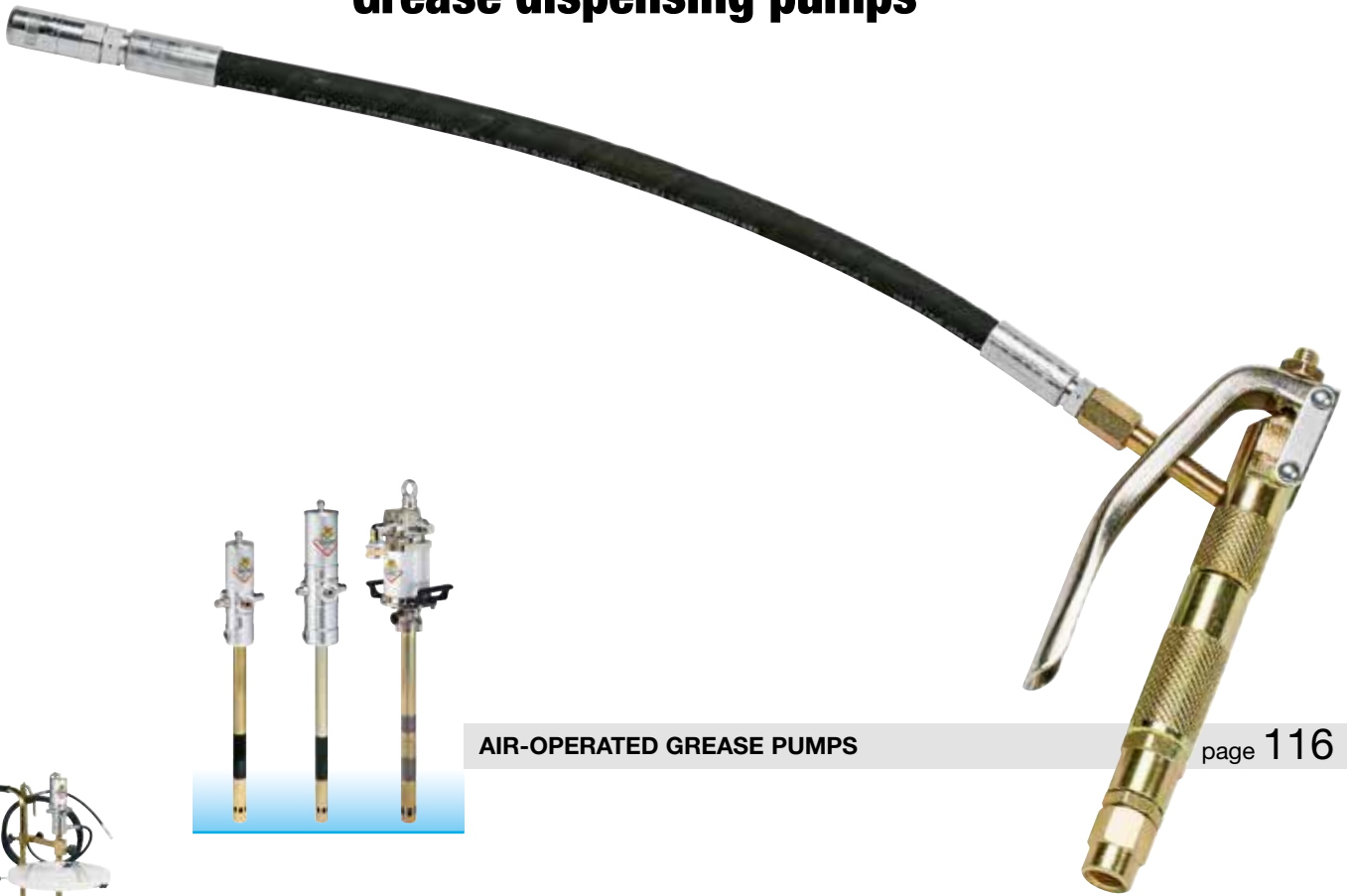

AIR-OPERATED GREASE PUMPS

page 116



GREASING KIT

page 120

5



GUNS AND ACCESSORIES

page 126



TROLLEYS FOR CONTAINERS 20 - 220 KG

page 130



Air-operated pumps for DISTRIBUTION grease

Ratio 50:1 Flow rate 1500 g/min

grease

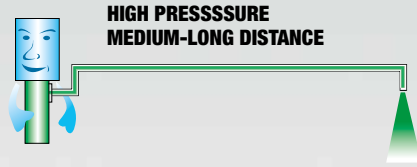
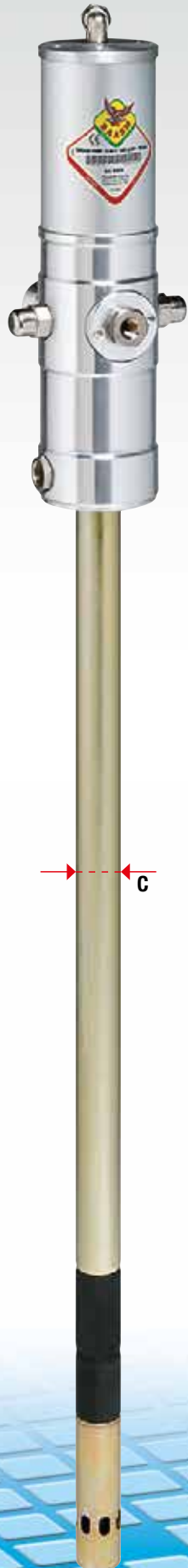

HIGH PRESSURE
MEDIUM-LONG DISTANCE

Series 600 air-operated pumps for short-long distance grease distribution, for high pressure greasing. Ideal for dispensing medium-high viscosity grease. Suitable for mobile installations and centralised fixed systems.

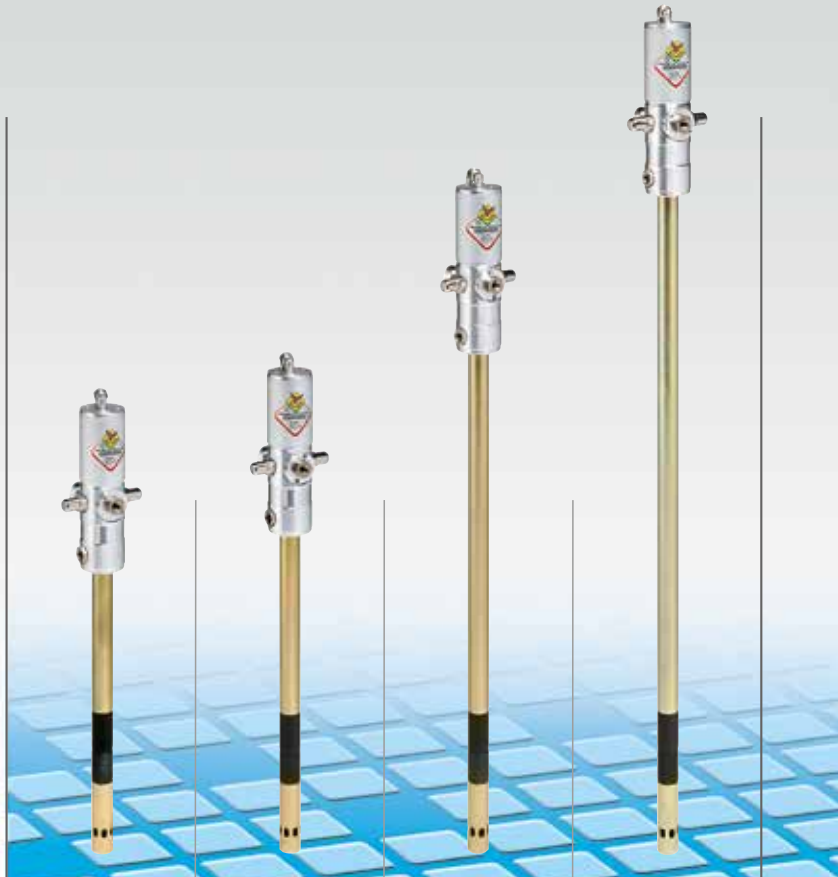

series 600

Article with seals in	PU	62041	62048	62074	62095
Compatible fluids		Greases, medium-high viscosity			
Suction tube upper body		Aluminium			
Suction tube		Carbon steel			
Air inlet connection	bsp	F 1/4" G	F 1/4" G	F 1/4" G	F 1/4" G
Fluid outlet connection	bsp	F 3/8" G	F 3/8" G	F 3/8" G	F 3/8" G
Air working pressure	bar	6 - 8	6 - 8	6 - 8	6 - 8
Average air consumption	l/min	330	330	330	330
Noise level	dB	81	81	81	81
Air max pressure	bar	8	8	8	8
Suitable for drums	kg	16 - 20	20 - 30	50 - 60	180 - 220
Pump	Art.	-	-	-	-
Hose reel	Art.	-	-	-	-
Gun	Art.	-	-	-	-
Drum cover	Art.	-	-	-	-
Follower plate	Art.	-	-	-	-
Connection hose	Art.	-	-	-	-
Nipple	Art.	-	-	-	-
Drip-tray	Art.	-	-	-	-
Packing	N° - m ³	1 - 0,010	1 - 0,010	1 - 0,020	1 - 0,020
Weight	kg	4,6	4,8	6,1	6,7
Dimensions (A - B - C)	cm	26,5 - 41 - 3	26,5 - 48 - 3	26,5 - 74 - 3	26,5 - 94 - 3

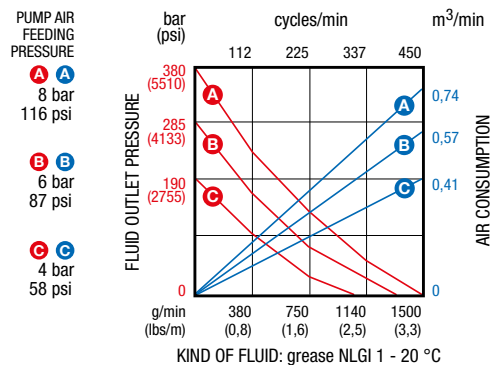

Ratio **65:1** Flow rate **1900 g/min**

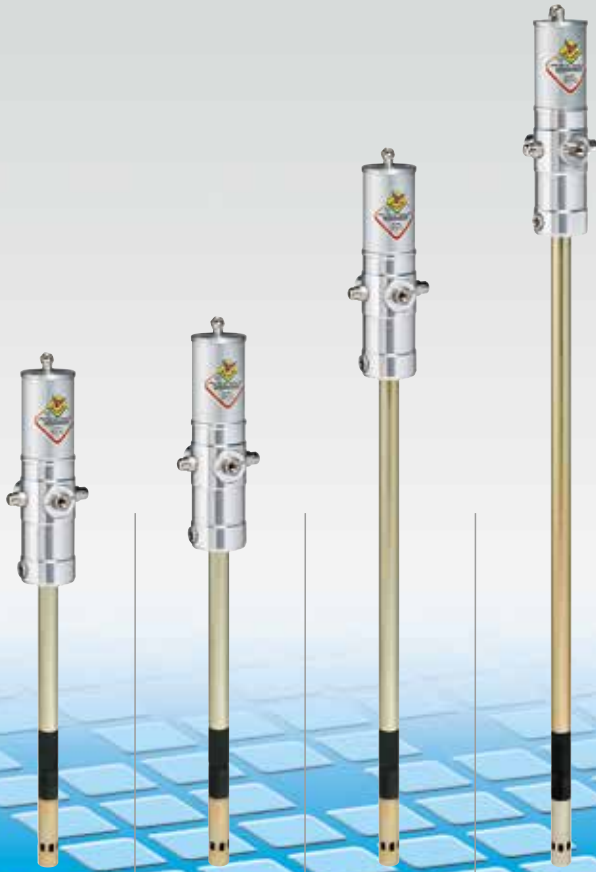

series **700**

63041 **63048** **63074** **63095**

Greases, medium-high viscosity

Aluminium

Carbon steel

F 1/4" G	F 1/4" G	F 1/4" G	F 1/4" G
F 3/8" G	F 3/8" G	F 3/8" G	F 3/8" G
6 - 8	6 - 8	6 - 8	6 - 8
440	440	440	440
81	81	81	81
8	8	8	8
16 - 20	20 - 30	50 - 60	180 - 220
-	-	-	-
-	-	-	-
-	-	-	-
-	-	-	-
-	-	-	-
-	-	-	-
-	-	-	-
-	-	-	-
1 - 0,010	1 - 0,010	1 - 0,020	1 - 0,020
5,9	6,1	7,4	8,2
33,5 - 41 - 3	33,5 - 48 - 3	33,5 - 74 - 3	33,5 - 94 - 3

PUMP AIR FEEDING PRESSURE

A 8 bar 116 psi

B 6 bar 87 psi

C 4 bar 58 psi

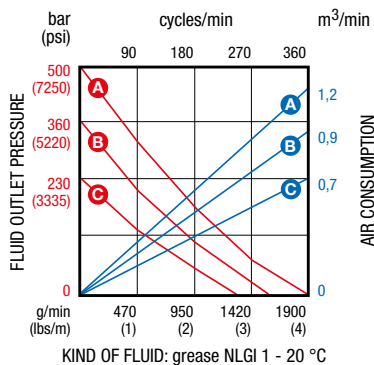

Ratio **50:1** Flow rate **1500 g/min**



series **600**

64200 **64210**

Greases, medium-high viscosity

Aluminium

Carbon steel

F 1/4" G	F 1/4" G
F 3/8" G	F 3/8" G
6 - 8	6 - 8
330	330
81	81
8	8
180 - 220	180 - 220
62095	62095
8420.501	8440.501
66889	66889
65600	65600
66590	66590
995.702	995.702
38073	38073
88630	88630
4 - 0,150	4 - 0,160
66,8	72

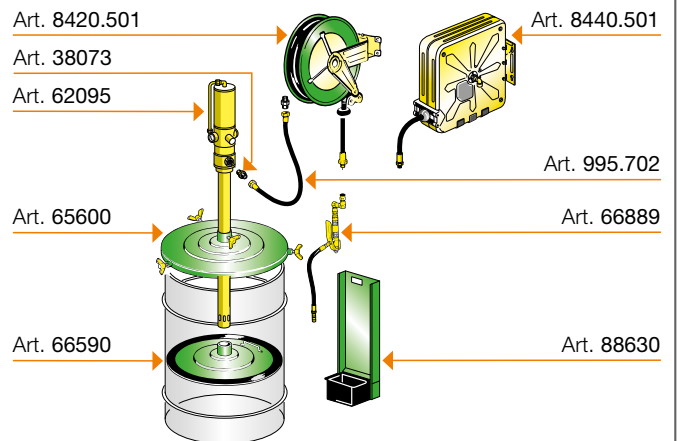



Air-operated pumps for DISTRIBUTION grease

grease

Ratio **45:1**
Flow rate **4400 g/min**

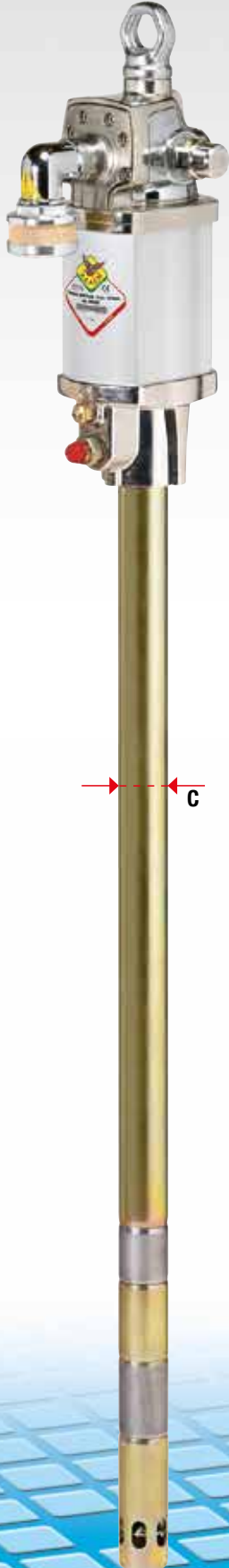

Series 900 industrial air-operated pumps for short-long distance grease distribution, for high pressure greasing. Ideal for transferring grease and high viscosity oil. The double action guarantees the delivery of a continuous and constant flow, suitable for the numerous needs of modern industry. The high quality of the materials used and the anticorrosion treatments reduce internal friction and limit wear over time.

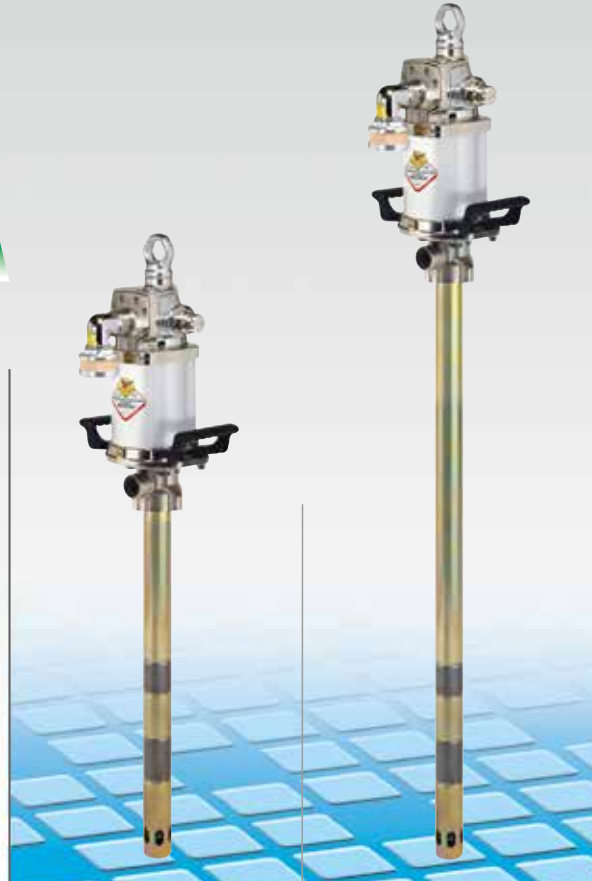

series **900**

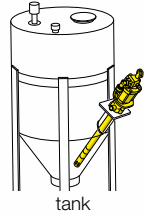
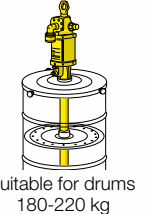
Article with seals in	PU	90F/451	91F/451
Compatible fluids		Greases, high viscosity oils	
Suction tube upper body		Carbon steel	
Suction tube		Carbon steel	
Air inlet connection	bsp	F 1/2" G	F 1/2" G
Fluid outlet connection	bsp	F 1/2" G	F 1/2" G
Flow rate	g/min	4400	4400
Max air consumption 8 bar	m ³ /min	1,6	1,6
Noise level	dB	80	80
Air max pressure	bar	8	8
Suitable for drums			 suitable for drums 180-220 kg
Packing	N° - m ³	1 - 0,050	1 - 0,070
Weight	kg	17	19
Dimensions (A - B - C)	cm	44,5 - 50 - 4,5	44,5 - 94 - 4,5

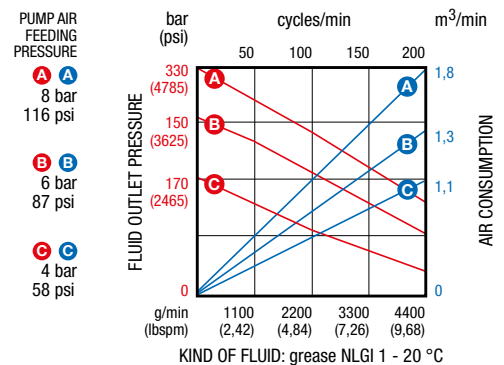
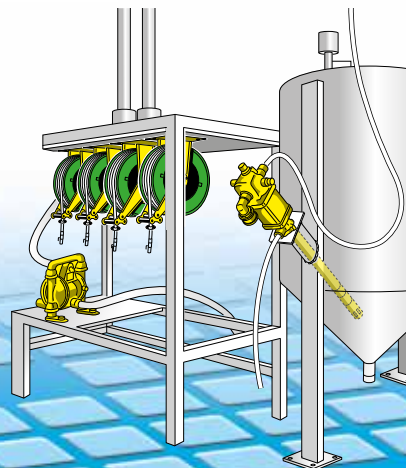

Ratio 70:1
Flow rate **3000 g/min**



series 900

91C/701

Greases, high viscosity oils

Aluminium
Carbon steel

F 1/2" G

F 1/2" G

3000

1,6

80

8

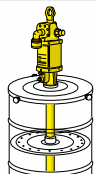

suitable for drums
180-220 kg

1 - 0,070

19

43 - 94 - 4,5

Ratio 75:1
Flow rate **4400 g/min**



series 1200

116F/751

117F/751

Greases, high viscosity oils

Carbon steel

F 1/2"

F 1/2"

4400

2,8

80

8

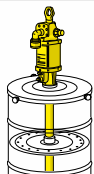

suitable for drums
180-220 kg

1 - 0,070

21

44,5 - 94 - 4,5



suitable for drums
50-60 kg

1 - 0,070

20

44,5 - 74 - 4,5

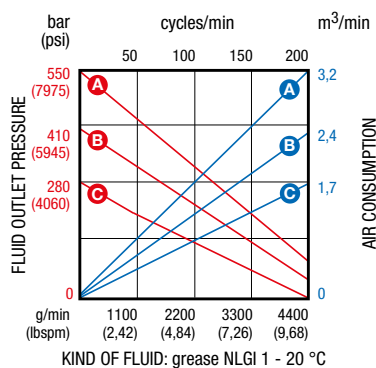
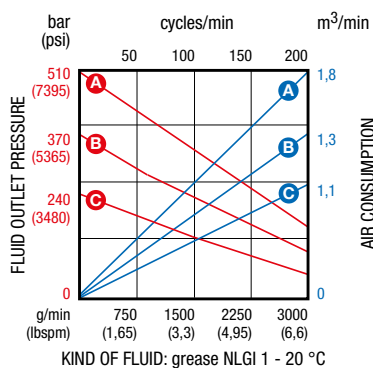

Ratio 40:1
Flow rate **10000 g/min**



with ram hoist Art.10/85

10/12401P1N

example of pump installation on a twin column ram hoist. For more info see page 212

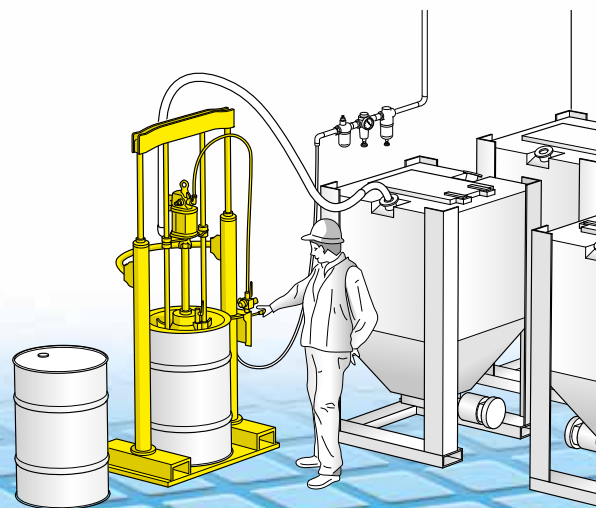



Mobile or fixed grease dispensing kits suitable for drums 180 - 220 kg

Mobile grease dispenser kits.

The ideal combination for dispensing grease in any workplace. The very easy to handle trolley is equipped with a drum (180 - 220 kg) clamping device, adjustable side support for hooking accessories, and wheel with brake. The mobile unit comes with a handy hose reel with 12 m of hose. By request the mobile unit can be equipped with other hose reels (see page 142).

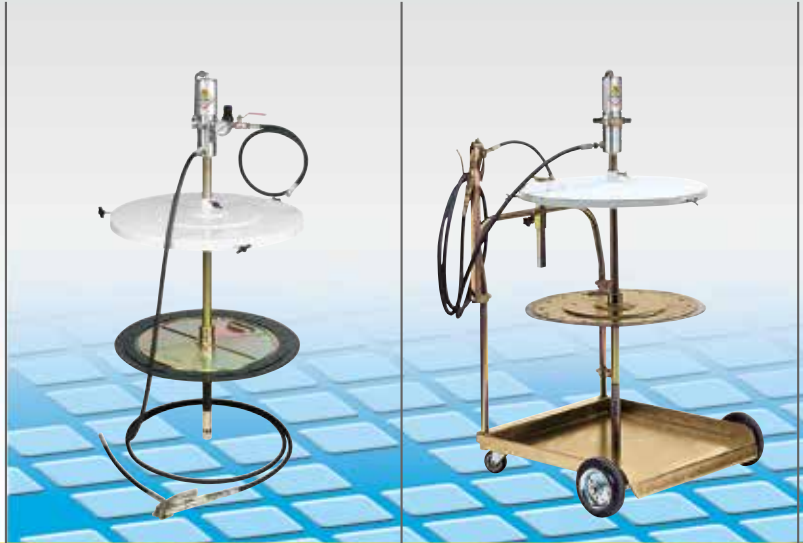

Article	64195	64196	64197	64070	64070/65	64070/75
Ratio	50:1	65:1	75:1	50:1	65:1	75:1
Flow rate g/min	1500	1900	4400	1500	1900	4400
For drums with external ø	from 550 to 600			from 550 to 600		
Pump	Art. 62095	Art. 63095	Art. 116F/751	Art. 62095	Art. 63095	Art. 116F/751
Trolley	Art. -	Art. -	Art. -	Art. 80200	Art. 80200	Art. 80200
Hose reel or delivery hose	Art. 993.504	Art. 993.504	Art. 993.504	Art. 993.504	Art. 993.504	Art. 993.504
Gun	Art. 66888	Art. 66888	Art. 66888	Art. 66888	Art. 66888	Art. 66888
Drum cover	Art. 65600	Art. 65600	Art. 10/50	Art. 65600	Art. 65600	Art. 10/50
Follower plate	Art. 66590	Art. 66590	Art. 10/60	Art. 66590	Art. 66590	Art. 10/60
Grease connecting hose	Art. -	Art. -	Art. -	Art. -	Art. -	Art. -
Air connecting hose	Art. 993.202	Art. 993.202	Art. 996.302	Art. -	Art. -	Art. -
Nipple	Art. 66892	Art. 66892	Art. 66893	Art. 66892	Art. 66892	Art. 66893
Air regulator	Art. 37801	Art. 37801	Art. 37814	Art. -	Art. -	Art. -
Air quick coupler	Art. 37805	Art. 37805	Art. 37807	Art. -	Art. -	Art. -
Packing N° - m ³	2 - 0,060	2 - 0,060	2 - 0,110	3 - 0,120	3 - 0,120	3 - 0,170
Weight kg	21	22,5	38	40,3	41,7	57
Dimensions (A - B - C) cm	60 - 60 - 120	60 - 60 - 127	60 - 60 - 138	67 - 77 - 131,5	67 - 77 - 131,5	67 - 77 - 131,5

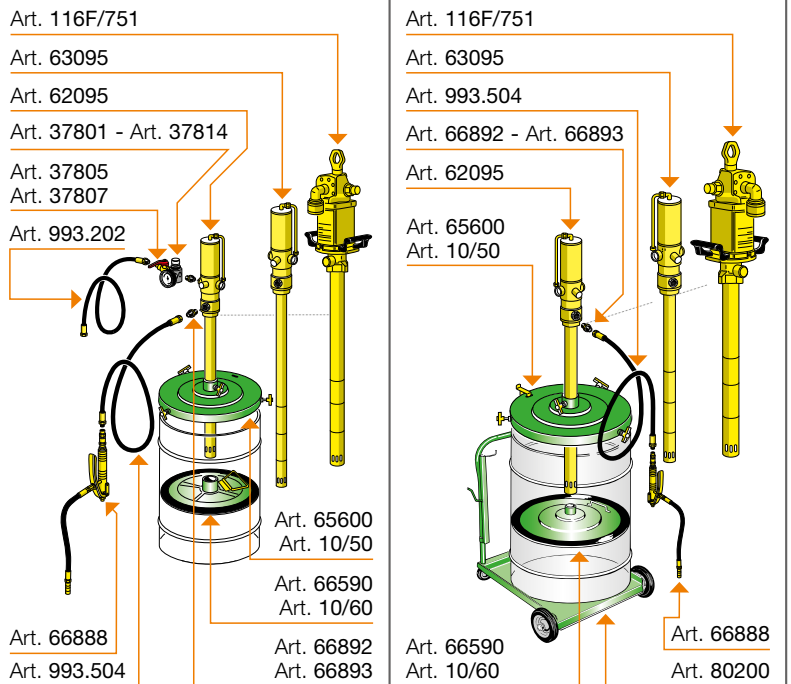
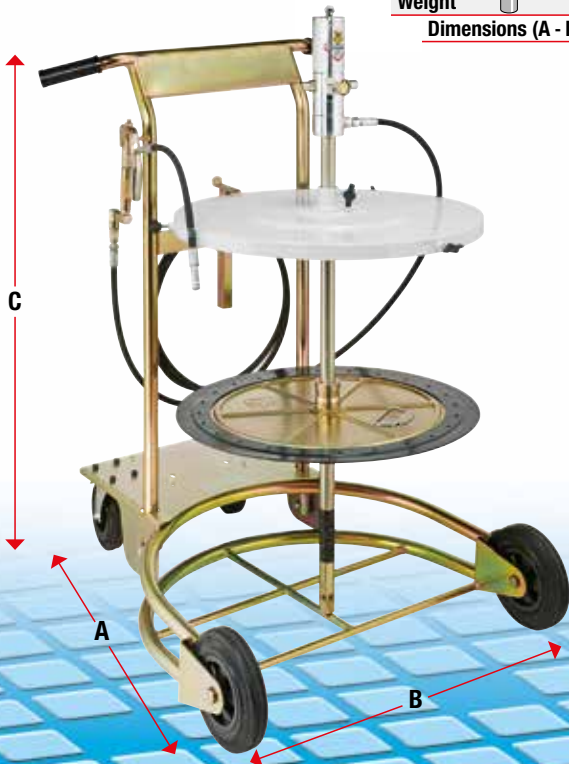

with hose reel

with hose reel

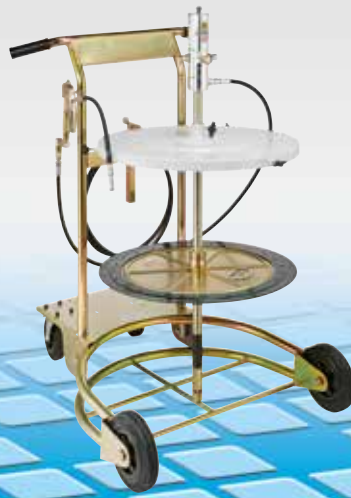

64000	64000/65	64000/75	64071	64071/65	64071/75	64001	64001/65	64001/75
50:1	65:1	75:1	50:1	65:1	75:1	50:1	65:1	75:1
1500	1900	4400	1500	1900	4400	1500	1900	4400
from 550 to 600			from 550 to 600			from 550 to 600		
62095	63095	116F/751	62095	63095	116F/751	62095	63095	116F/751
80201	80201	80201	80210	80210	80210	80210	80210	80210
8430.501	8430.501	8430.501	993.504	993.504	993.504	8430.501	8430.501	8430.501
66889	66889	66889	66889	66889	66889	66889	66889	66889
65600	65600	10/50	65600	65600	10/50	65600	65600	10/50
66590	66590	10/60	66590	66590	10/60	66590	66590	10/60
995.702	995.702	995.702	-	-	-	995.702	995.702	995.702
-	-	-	-	-	-	-	-	-
38073	38073	38072	66892	66892	66893	38073	38073	38072
-	-	-	-	-	-	-	-	-
4 - 0,234	4 - 0,234	4 - 0,285	3 - 0,120	3 - 0,120	3 - 0,170	4 - 0,234	4 - 0,234	4 - 0,285
86	87,5	102	45,8	47,2	62,5	66,2	67,6	82,5
93 - 81 - 137	93 - 81 - 137	93 - 81 - 137	90 - 77 - 126	90 - 77 - 126	90 - 77 - 126	90 - 77 - 126	90 - 77 - 126	90 - 77 - 126

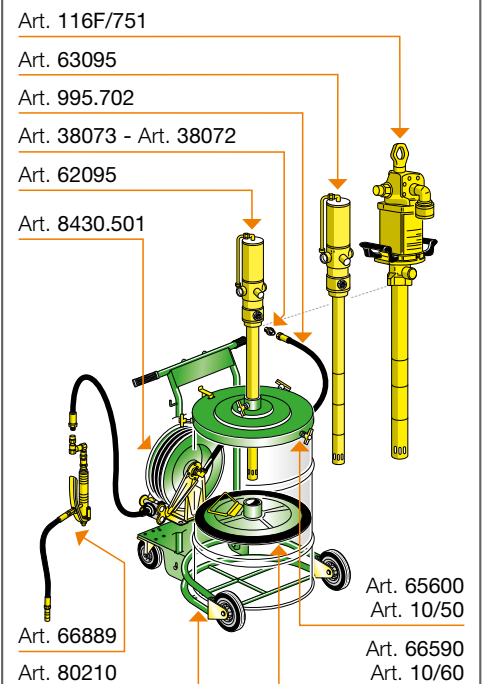
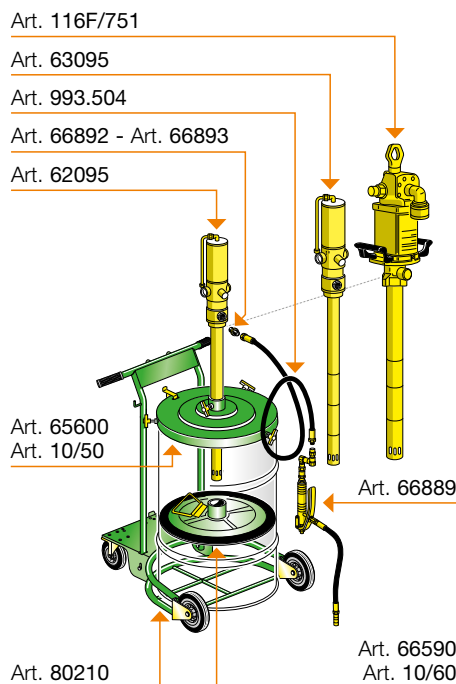
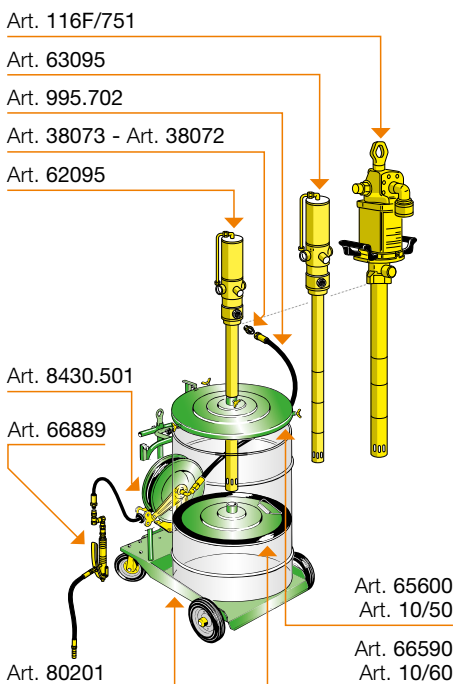



Mobile or fixed grease dispensing kits suitable for drums 50 - 60 kg

Mobile grease dispenser kits.

The ideal combination for dispensing grease in any workplace.

The compact trolley has 2 fixed wheels and 2 castors (Art. 80050) or only 2 fixed wheels (Art. 80040 and Art. 80035), that make it very easy to handle. It is equipped with a pump support and is suitable for small-medium size containers.

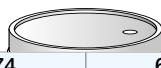
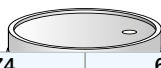

Article	64145	64146	64063	64064
Ratio	50:1	65:1	50:1	50:1
Flow rate	g/min	1500	1900	1500
For drums with external ø	from 370 to 420 		from 370 to 420 	
Pump	Art. 62074	Art. 63074	Art. 62074	Art. 62074
Trolley	Art. -	Art. -	Art. 80050	Art. 80050
Delivery hose	Art. 993.504	Art. 993.504	Art. 993.504	Art. 993.504
Air connecting hose	Art. 993.202	Art. 993.202	Art. -	Art. -
Gun	Art. 66888	Art. 66888	Art. 66888	Art. 66888
Drum cover	Art. 65420	Art. 65420	Art. 65420	Art. 65420
Follower plate	Art. 66400	Art. 66400	Art. -	Art. 66400
Nipple	Art. 66892	Art. 66892	Art. 66892	Art. 66892
Air regulator	Art. 37801	Art. 37801	Art. -	Art. -
Air quick coupler	Art. 37805	Art. 37805	Art. -	Art. -
Packing	Art. 2 - 0,040	Art. 2 - 0,040	Art. 3 - 0,059	Art. 3 - 0,059
Weight	kg 17	kg 18	kg 19,5	kg 22,4
Dimensions (A - B - C) cm	43 - 43 - 99	43 - 43 - 106	46 - 50 - 107,5	46 - 50 - 114,5

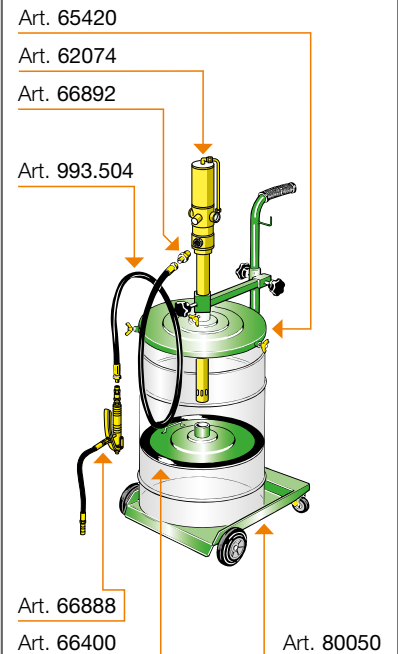
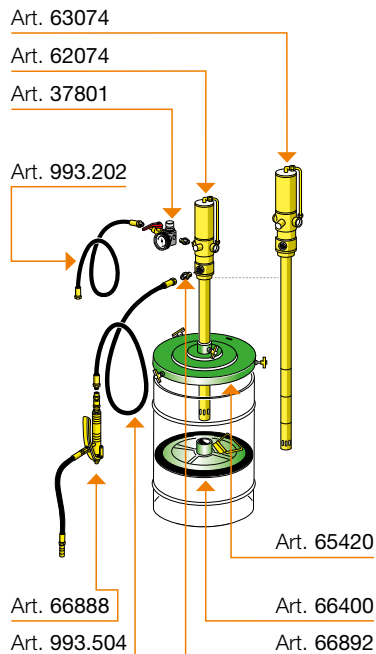
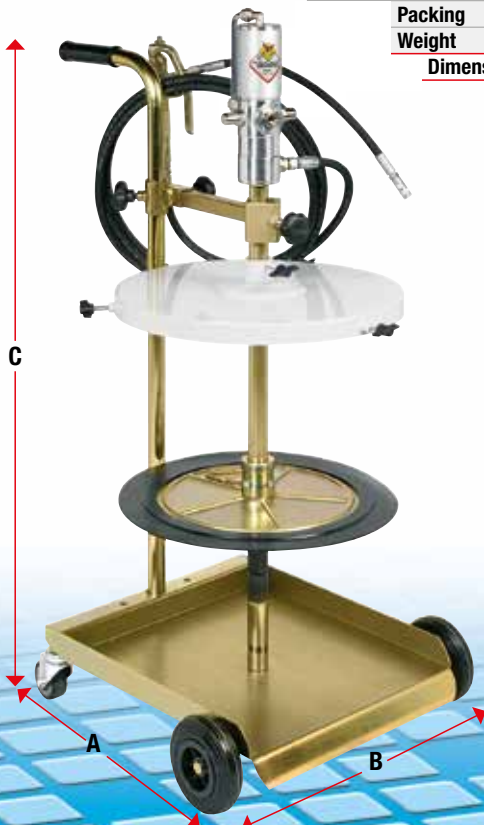

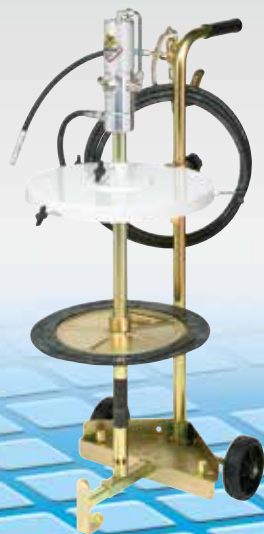

64040	64041	64037	64038	64042	64042/65	64039	64039/65
50:1	50:1	50:1	50:1	50:1	65:1	50:1	65:1
1500	1500	1500	1500	1500	1900	1500	1900
from 370 to 420		from 340 to 385		from 370 to 420		from 340 to 385	
62074	62074	62074	62074	62074	63074	62074	63074
80035	80035	80035	80035	80040	80040	80040	80040
993.504	993.504	993.504	993.504	993.504	993.504	993.504	993.504
-	-	-	-	-	-	-	-
66888	66888	66888	66888	66888	66888	66888	66888
65420	65420	65385	65385	65420	65420	65385	65385
-	66400	-	66370	66400	66400	66370	66370
66892	66892	66892	66892	66892	66892	66892	66892
-	-	-	-	-	-	-	-
-	-	-	-	-	-	-	-
3 - 0,048	3 - 0,048	3 - 0,048	3 - 0,048	3 - 0,048	3 - 0,048	3 - 0,048	3 - 0,048
19	22	18	20	22	23,5	21	22,5
44 - 39,5 - 106	44 - 39,5 - 106	44 - 39,5 - 106	44 - 39,5 - 106	43 - 47,5 - 107,5	43 - 47,5 - 114,5	43 - 47,5 - 107,5	43 - 47,5 - 114,5

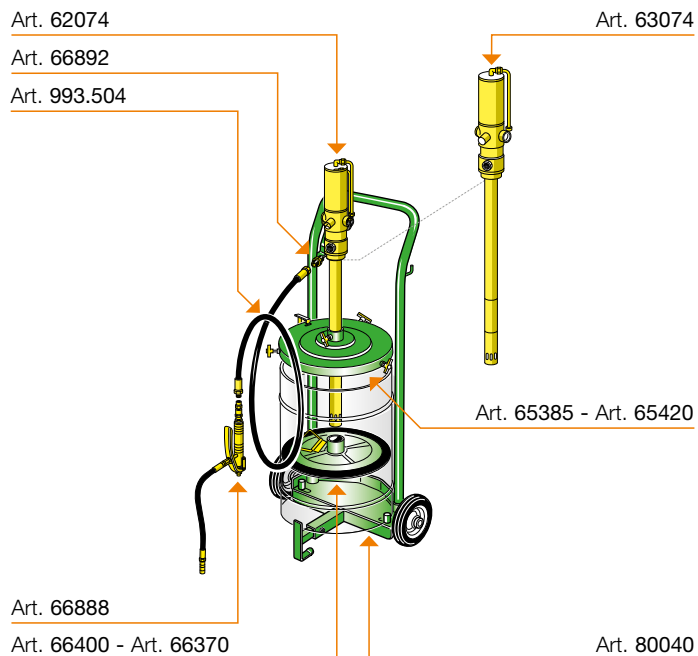
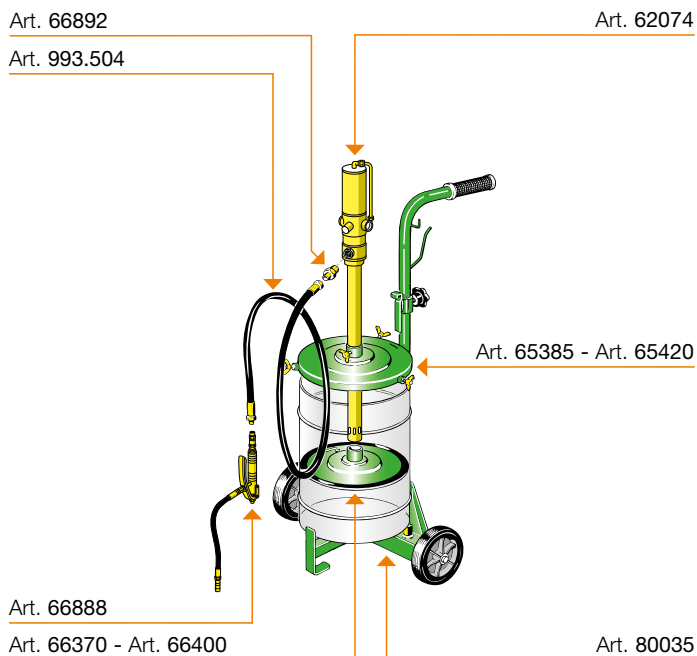



Mobile or fixed grease dispensing kits suitable for drums 12 - 30 kg



Mobile grease dispenser kits.

The ideal combination for dispensing grease in any workplace.

The compact trolley (Art. 80040 and Art. 80035) has 2 fixed wheels that make it very easy to handle.

It is equipped with a pump support and is suitable for small-medium size containers.

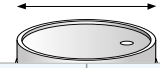
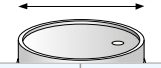

Article	64034	64035	64032	64033
Ratio	50:1	50:1	50:1	50:1
Flow rate g/min	1500	1500	1500	1500
For drums with external ø mm	from 300 to 350 		from 260 to 300 	
Pump Art.	62048	62048	62048	62048
Trolley Art.	80035	80035	80035	80035
Delivery hose Art.	993.504	993.504	993.504	993.504
Gun Art.	66888	66888	66888	66888
Drum cover Art.	65350	65350	65310	65310
Follower plate Art.	-	66340	-	66310
Nipple Art.	66892	66892	66892	66892
Kit carrying handle Art.	-	-	-	-
Packing  N° - m ³	3 - 0,040	3 - 0,040	3 - 0,040	3 - 0,040
Weight  kg	15,9	17,5	15	17
Dimensions (A - B - C) cm	44 - 39,5 - 99,5	44 - 39,5 - 99,5	44 - 39,5 - 99,5	44 - 39,5 - 99,5

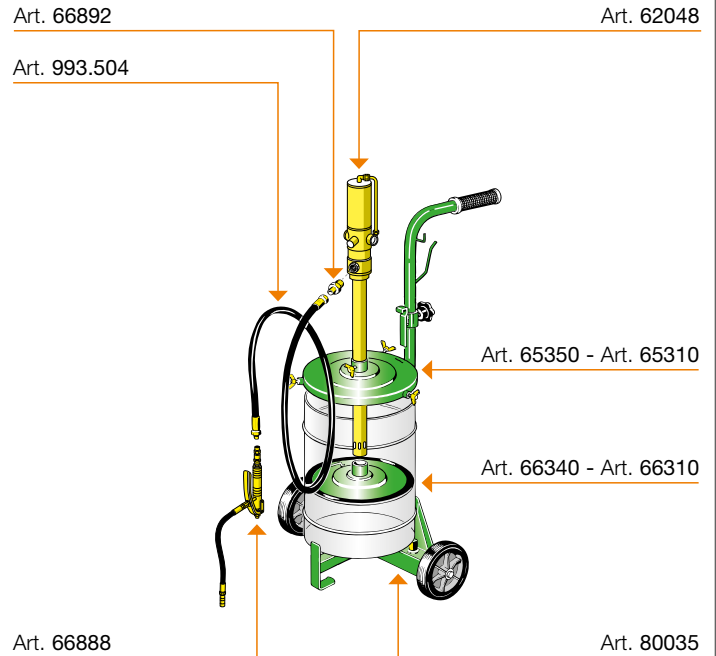
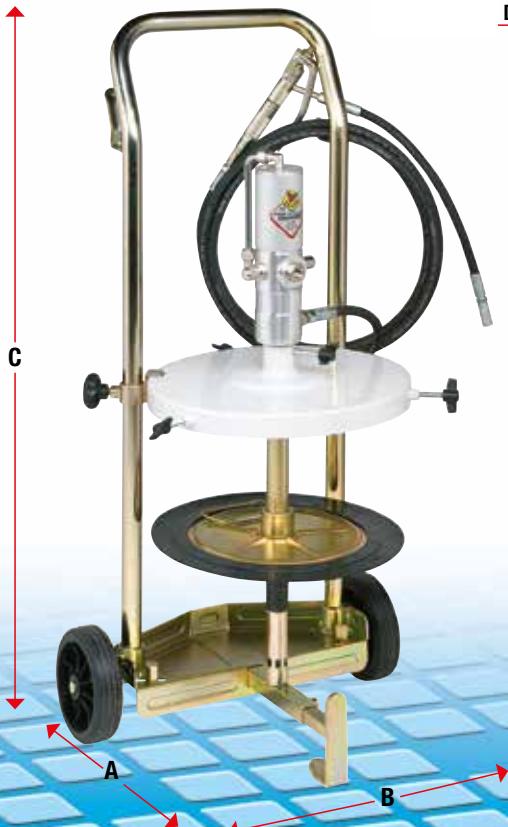

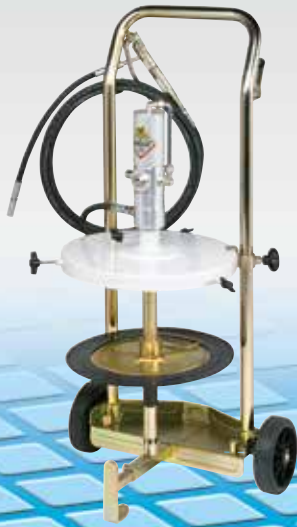

64036	64033/40	64025	64031	64021
50:1	50:1	50:1	50:1	50:1
1500	1500	1500	1500	1500
from 300 to 350	from 260 to 300	from 240 to 280	from 260 to 300	from 240 to 280
62048	62048	62041	62048	62041
80040	80040	80040	-	-
993.504	993.504	993.504	993.504	993.504
66888	66888	66888	66888	66888
65350	65310	65280	65310	65280
66340	66310	66265	66310	66265
66892	66892	66892	66892	66892
-	-	-	66599	66599
3 - 0,040	3 - 0,040	3 - 0,040	2 - 0,025	2 - 0,030
18,5	18	17	11,4	11
43 - 47,5 - 99	43 - 47,5 - 99	43 - 47,5 - 99	33 - 33 - 74,5	30 - 30 - 67,5

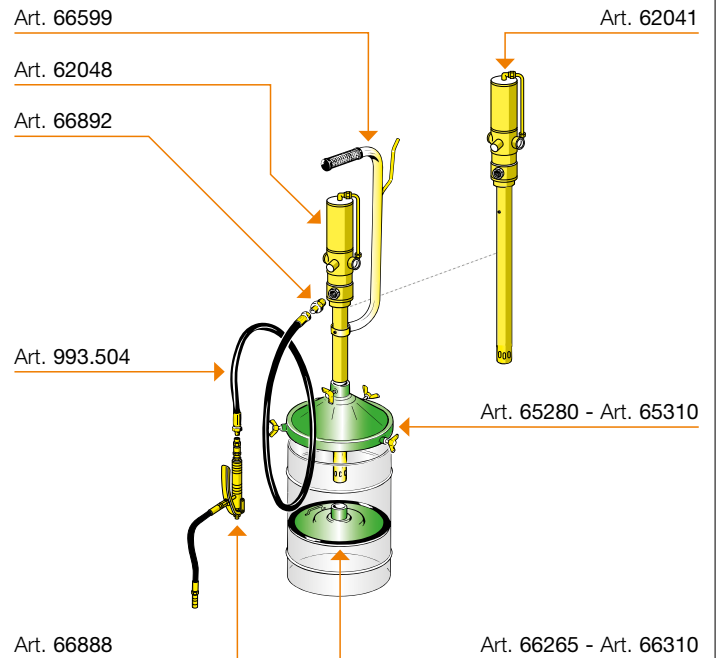
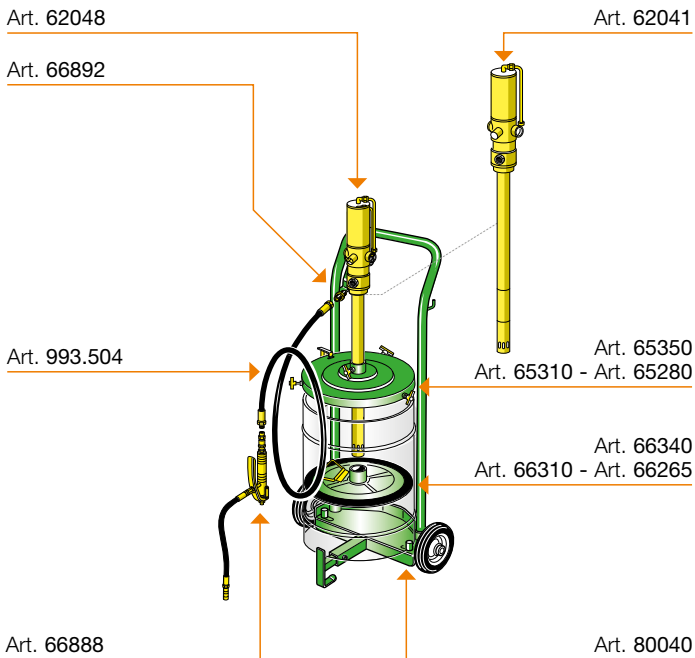



Accessories for grease pumps

Union \varnothing 30 mm

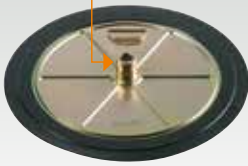

Follower plate for pumps series 600 - 700 with suction tube \varnothing 30

- Art. 66265 Follower plate \varnothing 265 mm (drum internal \varnothing 240 - 260 mm)
- Art. 66310 Follower plate \varnothing 303 mm (drum internal \varnothing 255 - 300 mm)
- Art. 66340 Follower plate \varnothing 340 mm (drum internal \varnothing 300 - 330 mm)
- Art. 66370 Follower plate \varnothing 370 mm (drum internal \varnothing 335 - 360 mm)
- Art. 66400 Follower plate \varnothing 400 mm (drum internal \varnothing 360 - 400 mm)
- Art. 66590 Follower plate \varnothing 585 mm (drum internal \varnothing 540 - 580 mm)

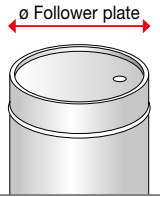

Union \varnothing 45 mm

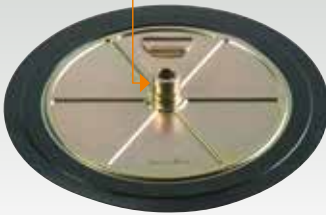

Follower plate for pumps series 900 - 1200 with suction tube \varnothing 45

- Art. 10/60 Follower plate \varnothing 585 mm (drum internal \varnothing 540 - 580 mm)
- Art. 10/61 Follower plate \varnothing 400 mm (drum internal \varnothing 360 - 400 mm)
- Art. 10/62 Follower plate \varnothing 370 mm (drum internal \varnothing 335 - 360 mm)
- Art. 10/63 Follower plate \varnothing 310 mm (drum internal \varnothing 255 - 300 mm)

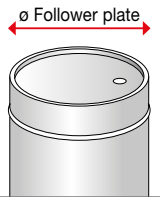

The **follower plate** is always recommended but becomes indispensable when using particularly hard greases. The follower plate is pulled towards the bottom of the drum by the vacuum created by the pump and always ensures the following advantages:

- it compresses the grease, preventing air pockets from forming and possible cavitation of the pump
- it keeps the grease clean, as well as preserving its characteristics
- it enables collection of all the grease from the bottom of the drum, that would otherwise remain stuck to the sides

Details and advantages

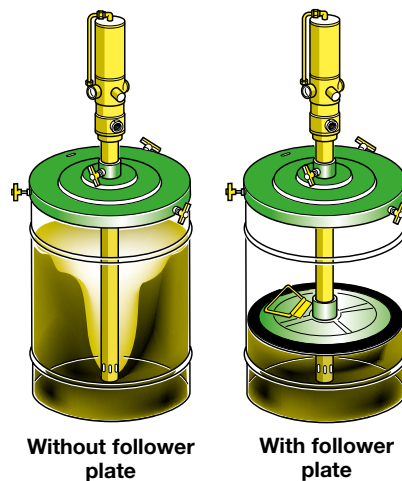

Without follower plate

With follower plate

The atmospheric pressure at sea-level is 1 bar, equivalent to approx. 1 kg per cm^2 . When the pump sucks the grease from the container, a vacuum is created under the follower plate and, at the same time, depending on the width of its surface, a pressure from 370 kg to 2000 kg is created above it.

Pump

Drum cover

Follower plate

Vacuum created by pump sucking the grease

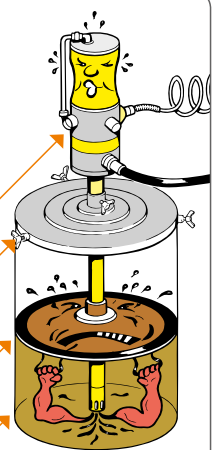

Union \varnothing 30 mm

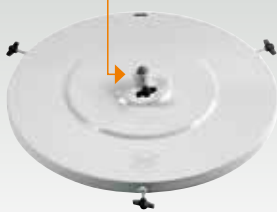

Drum cover for pumps series 600 - 700 with suction tube \varnothing 30

- Art. 65280 Drum cover \varnothing 280 mm (drums external \varnothing 240 - 280 mm)
- Art. 65310 Drum cover \varnothing 310 mm (drums external \varnothing 260 - 300 mm)
- Art. 65350 Drum cover \varnothing 350 mm (drums external \varnothing 300 - 350 mm)
- Art. 65385 Drum cover \varnothing 385 mm (drums external \varnothing 340 - 385 mm)
- Art. 65420 Drum cover \varnothing 420 mm (drums external \varnothing 370 - 420 mm)
- Art. 65600 Drum cover \varnothing 600 mm (drums external \varnothing 550 - 600 mm)

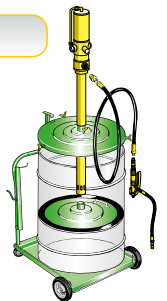

Union \varnothing 45 mm



Drum cover for pumps series 900 - 1200 with suction tube \varnothing 45

- Art. 10/50 Drum cover \varnothing 600 mm (drums external \varnothing 550 - 600 mm)
- Art. 10/51 Drum cover \varnothing 420 mm (drums external \varnothing 370 - 420 mm)
- Art. 10/52 Drum cover \varnothing 385 mm (drums external \varnothing 340 - 385 mm)

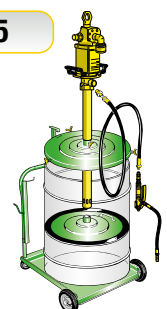



Accessories for grease pumps

Union \varnothing 25 - 30 - 38 mm



Drum cover for manual pumps with suction tube \varnothing 25 - 30 - 38

- Art. **65309** Drum cover \varnothing 337 mm
(drums external \varnothing 270 - 330 mm) for Art. 60311 (suction tube \varnothing 25 mm)
- Art. **65311** Drum cover \varnothing 337 mm
(drums external \varnothing 270 - 330 mm) for Art. 60411 (suction tube \varnothing 38 mm)
- Art. **65312** Drum cover \varnothing 337 mm
(drums external \varnothing 270 - 330 mm) for pumps with \varnothing 30 mm suction tube

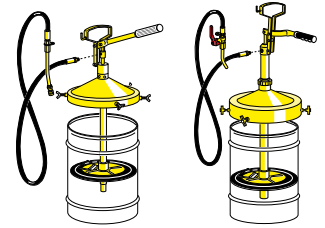

- Art. **66891** Nipple M 1/4"G x
M 1/4"G tapered/cylindrical thread
- Art. **66892** Nipple M 1/4"G x
M 3/8"G cylindrical/cylindrical thread
- Art. **66893** Nipple M 1/4"G x
M 1/2"G cylindrical/cylindrical thread



- Art. **66739** 4-jaw grease coupler
with antisplash valve fitted standard
on manual grease pumps. Inlet M10x1
- Art. **66740** Special 4-jaw grease
coupler with antisplash valve fitted
standard on all grease guns. Inlet M10x1



- Art. **66895**
Nipple M 3/8"G x F 1/4"NPT
- Art. **66896**
Nipple M 1/4"G x F 1/4"NPT
- Art. **66897**
Nipple F 1/4"G x M 1/4"NPT



- Art. **66741**
90° grease coupler.
Inlet thread M10x1



- Art. **60450**
Female quick connector
complete with check valve -
F 1/4"G max pressure 350 bar

* articles not manufactured by us



- Art. **66742**
Hooking grease coupler hexagon
15 mm - round 16 mm coupler.
Inlet thread M10x1



- Art. **60451**
Male quick connector
complete with check valve -
F 1/4"G max pressure 350 bar

* articles not manufactured by us



- Art. **66743**
Push-on grease hexagon
15 mm - round 16 mm coupler.
Inlet thread M10x1



- Art. **66661**
Straight single swivel joint
M/F 1/4" G supplied with grease
guns Art. 66888 - Art. 66881

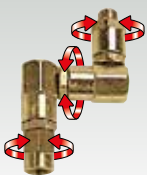

- Art. **66663**
Triple swivel joint
M/F 1/4" G supplied with grease
guns Art. 66889 - Art. 66882



- Art. **66599**
Handle for portable grease kit
supplied with grease kits Art. 64020 -
Art. 64021 - Art. 64030 - Art. 64031



- Art. **993.201**
Hose M/F 1/4" - 1 m - 20 bar
- Art. **993.202**
Hose M/F 1/4" - 2 m - 20 bar
- Art. **993.504**
Hose M/F 1/4" - 4 m - 400 bar
- Art. **993.512**
Hose M/F 1/4" - 12 m - 400 bar
- Art. **993.518**
Hose M/F 1/4" - 18 m - 400 bar
- Art. **995.701**
Hose M/F 3/8" - 1 m - 400 bar
- Art. **995.702**
Hose M/F 3/8" - 2 m - 400 bar
- Art. **995.710**
Hose F 3/8" x M 1/4" - 10 m - 400 bar
- Art. **995.715**
Hose F 3/8" x M 1/4" - 15 m - 400 bar



Grease guns



Flexible terminal

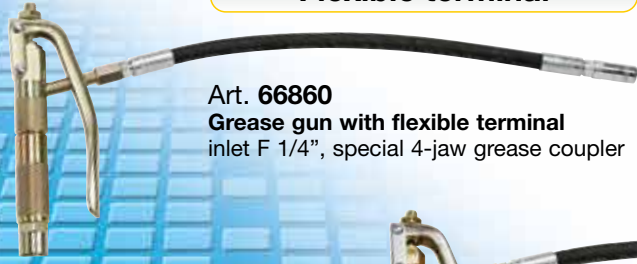

Art. 66860
Grease gun with flexible terminal
inlet F 1/4", special 4-jaw grease coupler

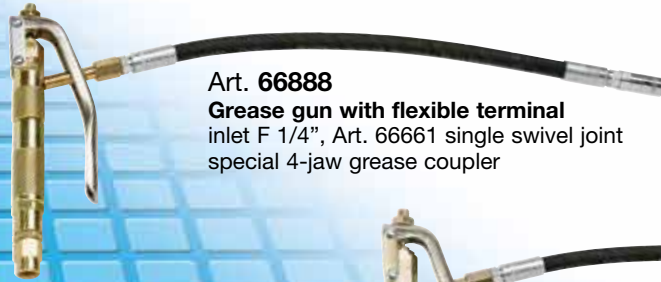

Art. 66888
Grease gun with flexible terminal
inlet F 1/4", Art. 66661 single swivel joint
special 4-jaw grease coupler



Art. 66889
Grease gun with flexible terminal
inlet F 1/4", Art. 66663 triple swivel joint
special 4-jaw grease coupler

Without terminal



Art. 66855
Grease gun
valve inlet F 1/4"

Rigid terminal



Art. 66880
Grease gun with rigid terminal
inlet F 1/4", with special 4-jaw
grease coupler



Art. 66881
Grease gun with rigid terminal
inlet F 1/4", Art. 66661 single swivel joint
with special 4-jaw grease coupler



Art. 66882
Grease gun with rigid terminal
inlet F 1/4", Art. 66663 triple swivel joint
with special 4-jaw grease coupler



Art. 66856
Flexible terminal with special 4-jaw grease coupler



Art. 66857
Rigid terminal with special 4-jaw grease coupler



Accessories for grease pumps

*



Art. 37801

Pressure regulator with pressure gauge, connections M/F 1/4" G. Applied on a pump or on the tank of a suction/drainer, for regulating the compressed air inlet pressure

Art. 37814

Pressure regulator with pressure gauge, connections M/F 1/2" G. Applied on a pump or on the tank of a suction/drainer, for regulating the compressed air inlet pressure

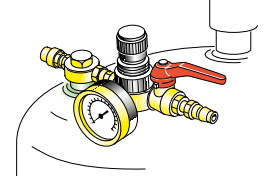

* articles not manufactured by us

*



Art. 37810

Pressure regulator with condensate discharge filter and pressure gauge, connections F/F 1/4" G for application at the start of the compressed air line feeding the pump

Art. 37815

Pressure regulator with condensate discharge filter and pressure gauge, connections F/F 1/2" G for application at the start of the compressed air line feeding the pump

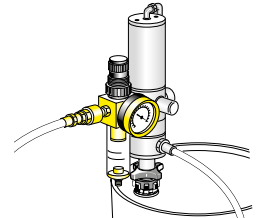

* articles not manufactured by us

*



Art. 37811

Air lubricator, connections F/F 1/4" G. Its application guarantees better efficiency of the pump over time

Art. 37816

Air lubricator, connections F/F 1/2" G. Its application guarantees better efficiency of the pump over time

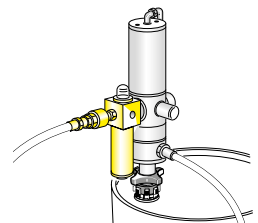

* articles not manufactured by us

*



Art. 37812

Pressure regulator with condensate discharge filter, air lubricator and pressure gauge. Connections F/F 1/4" G the system guarantees that the pump feed air is free of condensate

Art. 37817

Pressure regulator with condensate discharge filter, air lubricator and pressure gauge. Connections F/F 1/2" G the system guarantees that the pump feed air is free of condensate

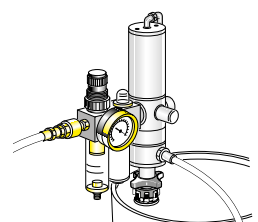

* articles not manufactured by us



MODULAR Trolleys

for drums 20 - 60 kg

Modular trolleys, entirely galvanised, suitable for handling 20 - 220 kg drums. Equipped with 2 or 4 high fluency wheels that make them very easy to handle. Their compact size ensures perfect integration in the workplace and their modularity enables compact packing for easy storage.



Article	80035	80040	80050
Suitable for drums	20 - 60	20 - 60	20 - 60
Packing N° - m ³	1 - 0,010	1 - 0,010	1 - 0,020
Weight	5	6	9,2
For drums with max external (D)	39	44	39,5
Dimensions (A - B - C)	44 - 39,5 - 99,5	43 - 47,5 - 99	46 - 50 - 99

Packing dimensions

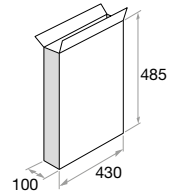
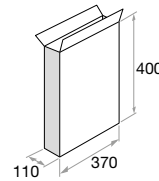
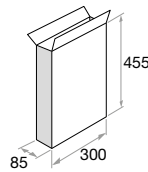

Modular structure

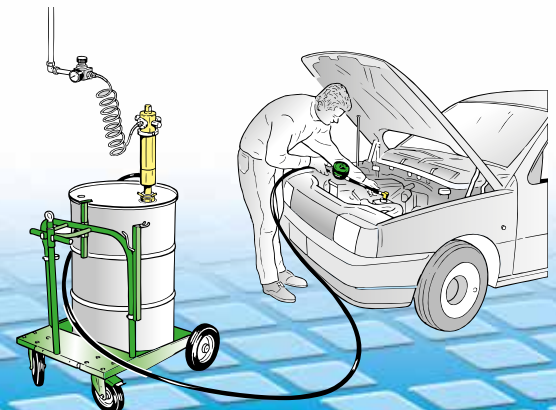
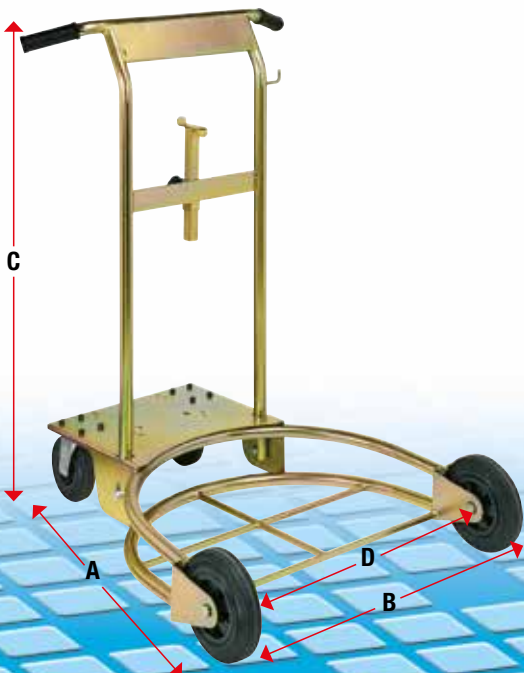
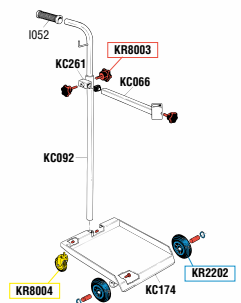
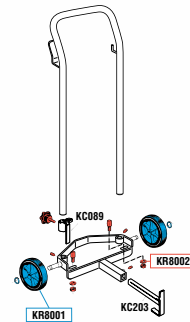
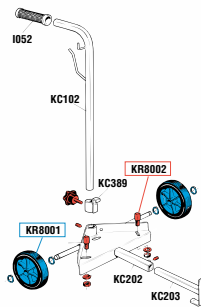

for drums 180 - 220 kg



80200	80201	80210	80215
180 - 220	180 - 220	180 - 220	180 - 220
1 - 0,060	1 - 0,100	1 - 0,18	2 - 0,028
21,9	45,9	26,2	44
61,5	61,5	61,5	61,5
67 - 77 - 87	93 - 81 - 103	90 - 77 - 115	90 - 77 - 176

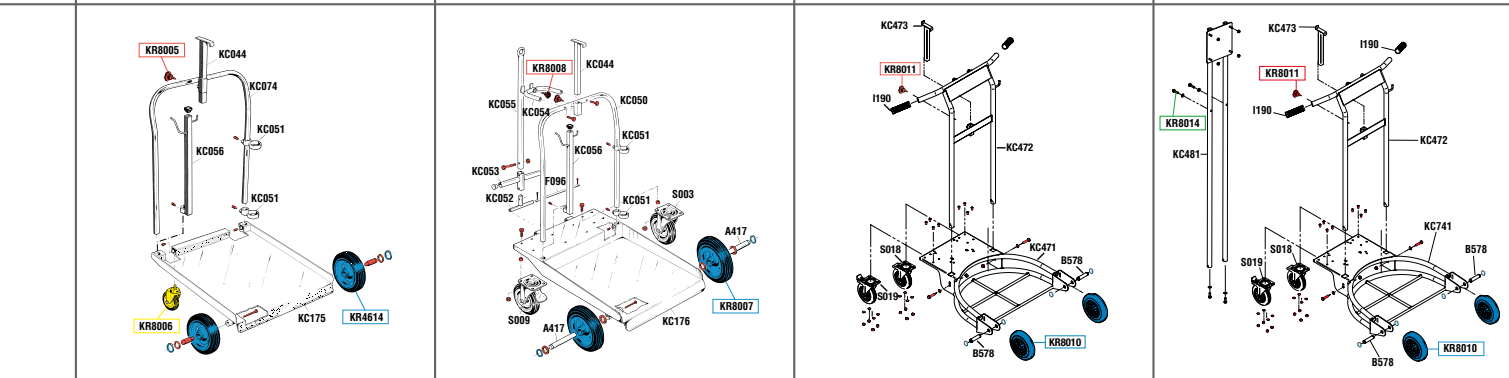
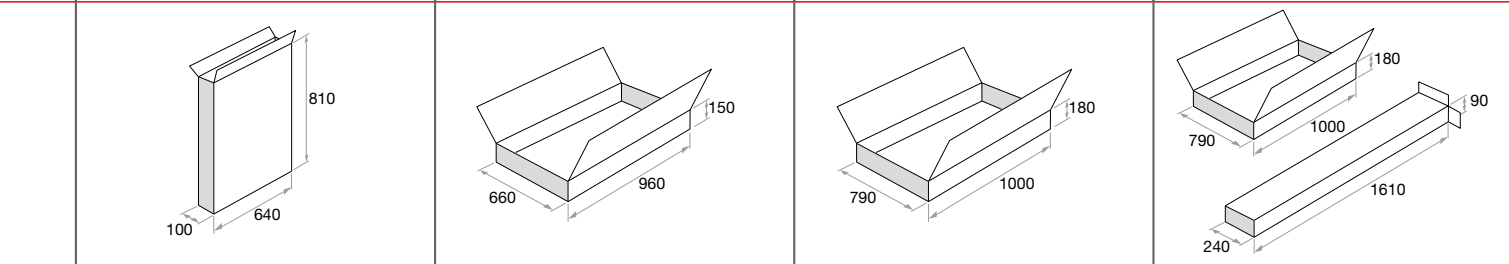

Technical features Designed to complete our articles such as oil and grease kits

Art. 80035 - Art. 80040

Art. 80200 - Art. 80201
Art. 80210

Art. 80215
Pump, hose reel and oil gun not included



FLUIDS AND LUBRICATION EQUIPMENT



Service columns



FRONTAL SERVICE COLUMNS page 134



BILATERAL SERVICE COLUMNS page 136





FRONTAL/BILATERAL SERVICE COLUMNS page 138

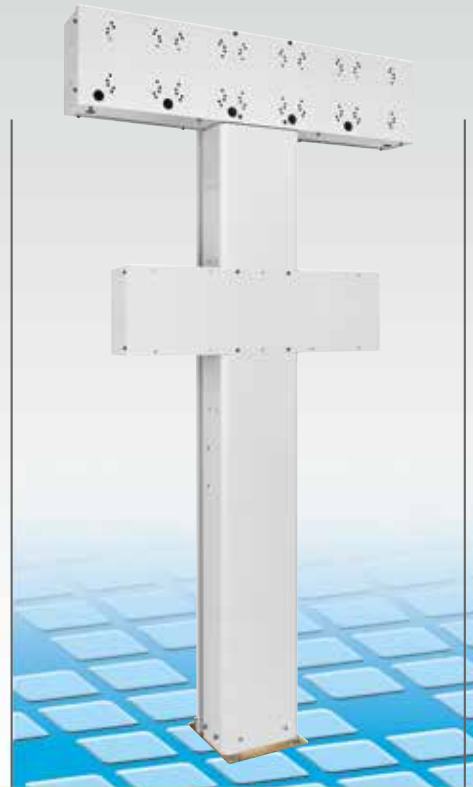
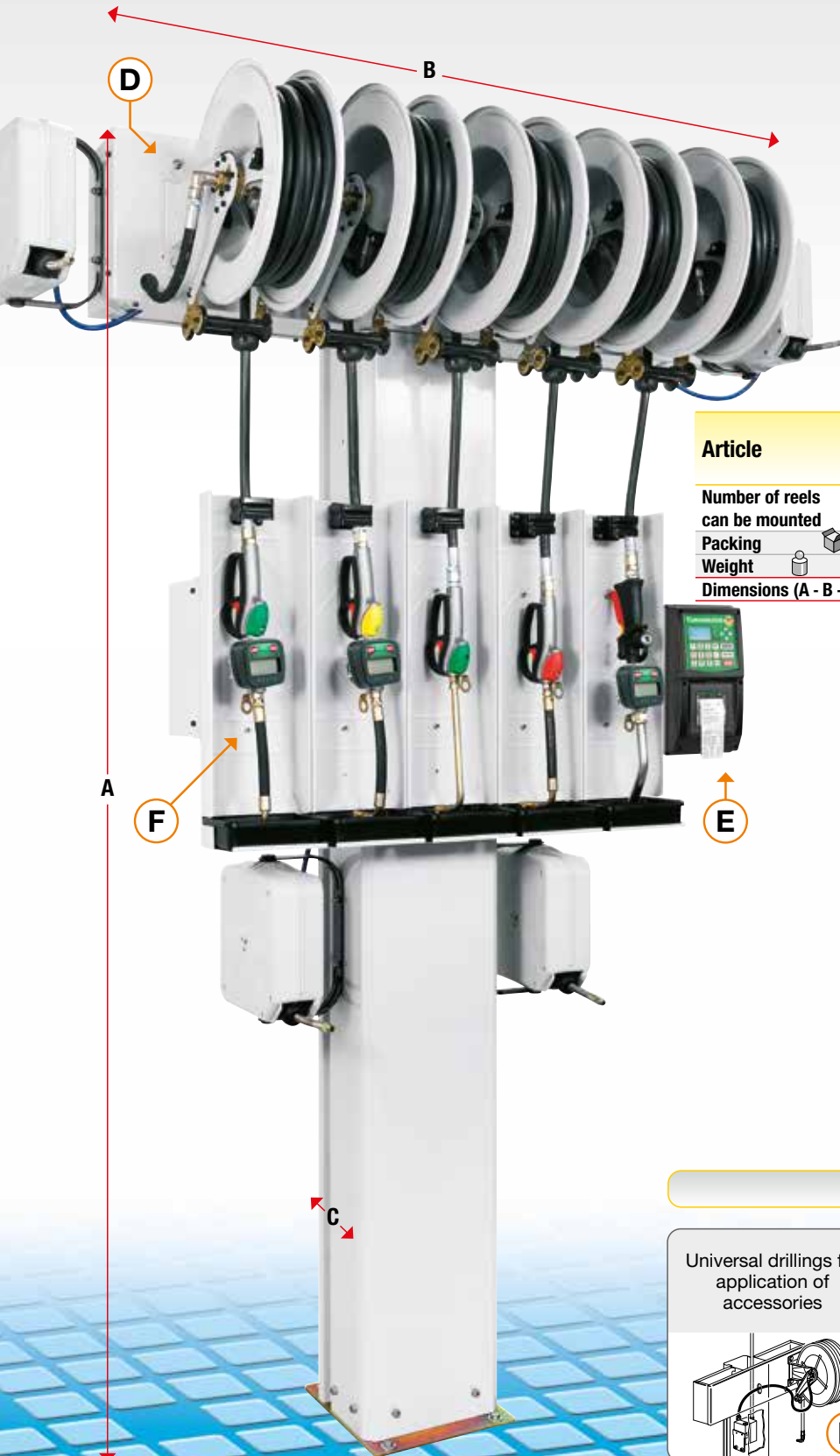

FRONTAL service columns

Frontal service columns. Ideal service stations for rationalising the areas dedicated to delivery. Installable on walls, connected to the centralised distribution system, they are real independent operational stations. Made from top quality materials, with scratchproof painting.



Article	39323	39334	39335
Number of reels can be mounted	3	4	5
Packing  N° - m ³	1 - 0,265	1 - 0,460	1 - 0,460
Weight  kg	54,5	84,5	91
Dimensions (A - B - C) cm	245 - 86 - 13	251 - 110 - 24	251 - 134 - 24

**Art. 88630
Modular drip-tray.**
Equipped with hook for gun and removable drip-tray. Applied under the hose reel, it is a handy holder for the delivery gun. Essential for a clean and orderly workplace.



Details and advantages

Universal drillings for application of accessories

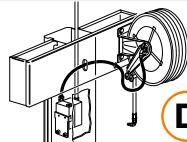

Arrangement for fixing the fluids control system

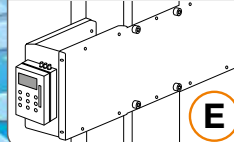

Holes for drip tray

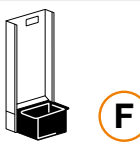

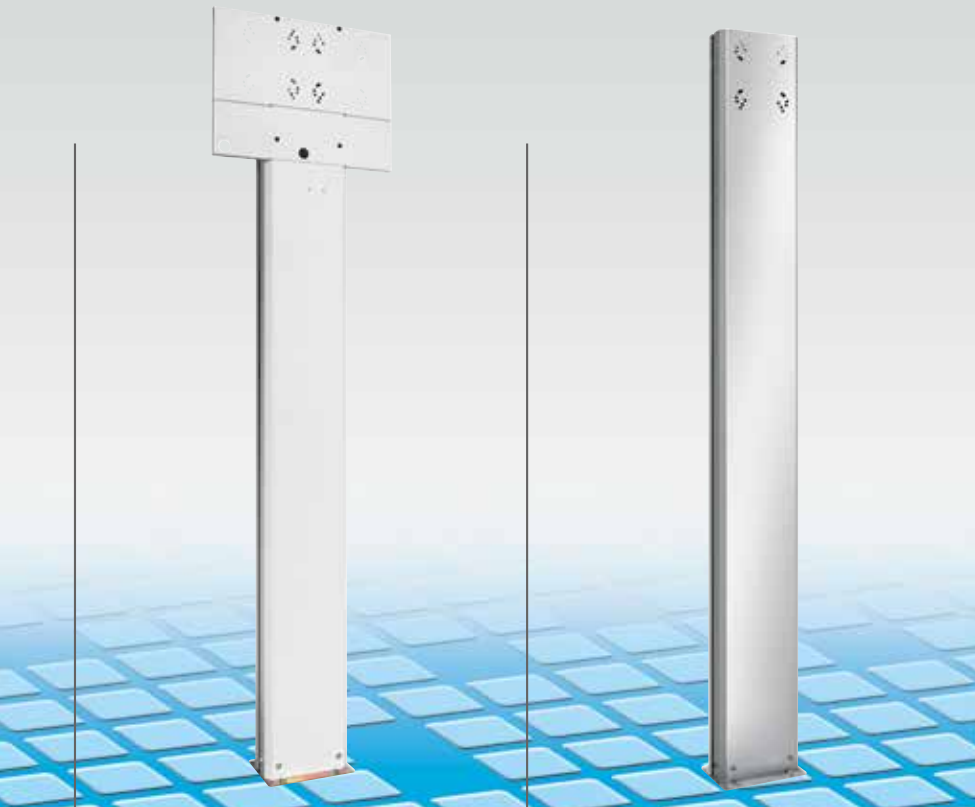

39322	39422 AISI 304 S. Steel	39320 for suction	39321	39421 AISI 304 S. Steel
2	2	1	1	1
1 - 0,265	1 - 0,265	1 - 0,265	1 - 0,265	1 - 0,265
48,5	44	41	42	37
245 - 62 - 13	245 - 62 - 13	245 - 29 - 12,5	245 - 29 - 12,5	245 - 29 - 12,5

The upper part of the support is arranged with holes for the application of hose reels series 330 - 390 - 430 - 450 - 530 and solenoid valves for stopping the fluid. The drip-tray can be applied frontally.

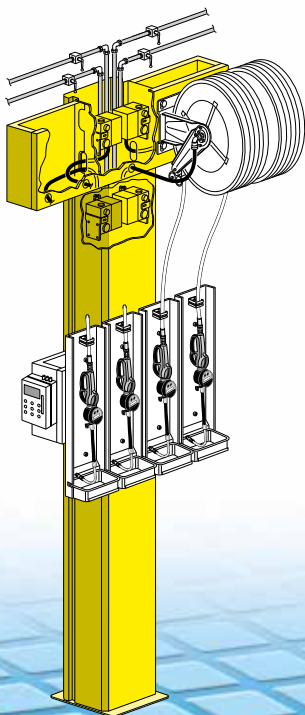

Ceiling installation

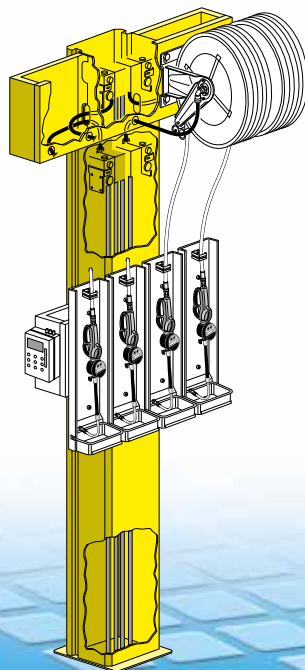



Floor installation

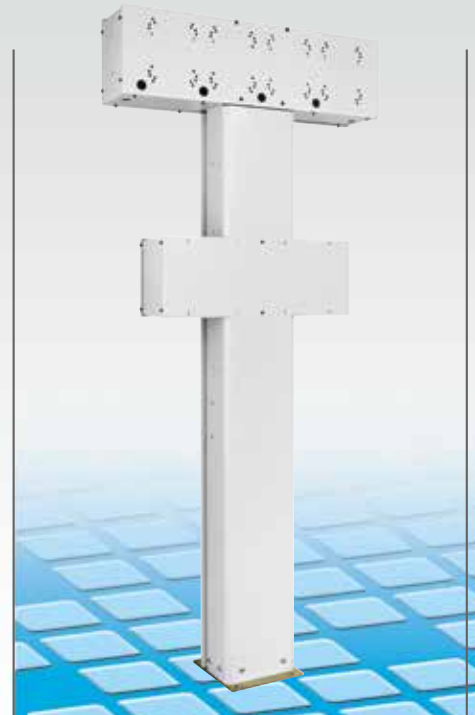
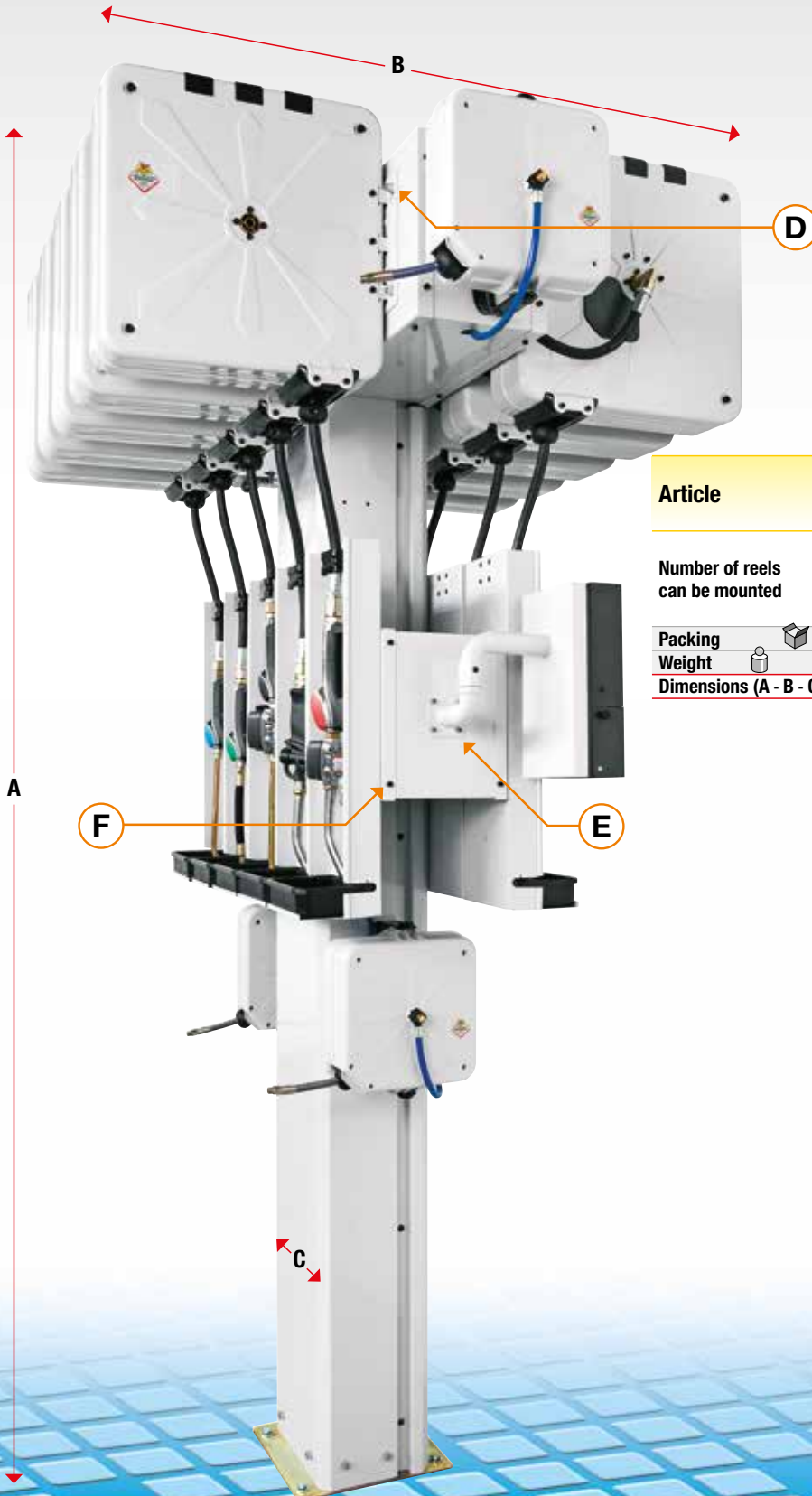

BILATERAL service columns

Bilateral service columns, usable from both sides for access. Installable anywhere in the workplace, connected to the centralised distribution system, they are real independent operational stations. Made from top quality materials, with scratchproof painting, and full width drip trays.



Article	39336	39338	39340
Number of reels can be mounted	3 + 3 + (4 hose reels S. 250 - 260 280 - 300)	4 + 4 + (4 hose reels S. 250 - 260 280 - 300)	5 + 5 + (4 hose reels S. 250 - 260 280 - 300)
Packing  N° - m ³	1 - 0,460	1 - 0,460	1 - 0,460
Weight  kg	86	94	101
Dimensions (A - B - C) cm	251 - 86 - 24	251 - 110 - 24	251 - 134 - 24

The upper part of the support is arranged with holes for the application of hose reels series 330 - 390 - 430 - 450 - 530 and solenoid valves for stopping the fluid. The drip-tray can be applied frontally.

Details and advantages

Universal drillings for application of accessories

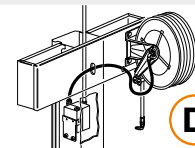

D

Arrangement for fixing the fluids control system

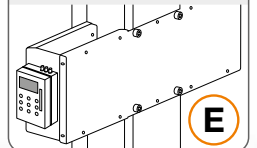

E

Holes for drip tray

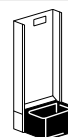

F

Drip-tray

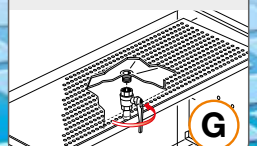

G

Art. 88630
Modular drip-tray.
 Equipped with hook for gun and removable drip-tray. Applied under the hose reel, it is a handy holder for the delivery gun. Essential for a clean and orderly workplace.

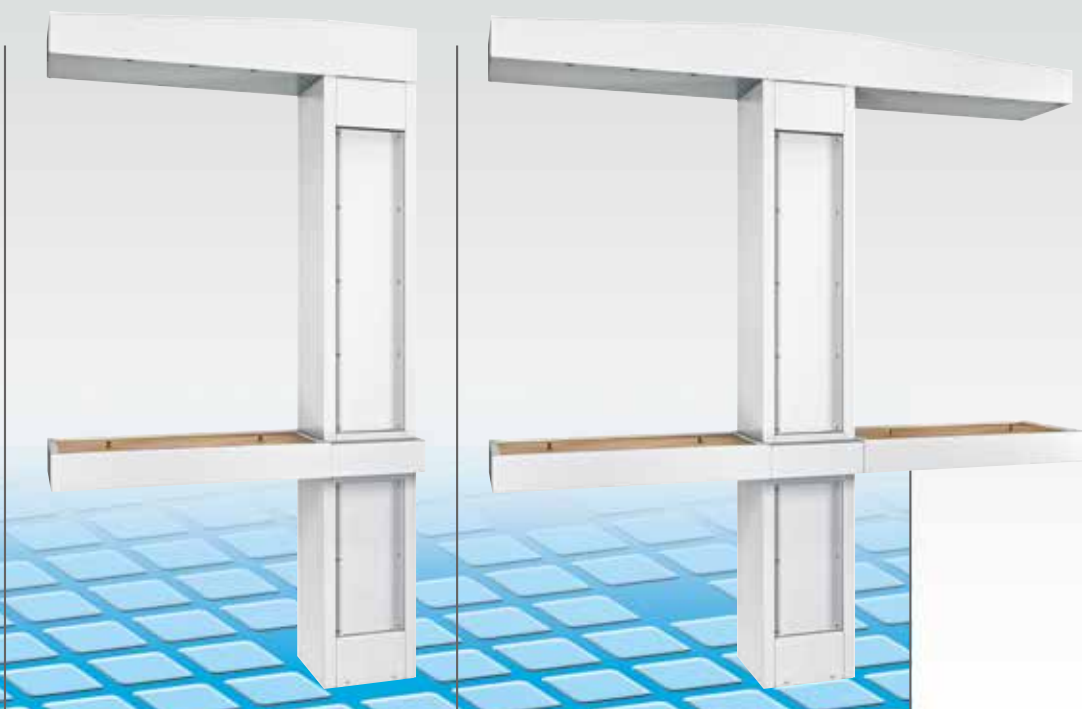

39324

39328

4 + (2 hose reels
 S. 250 - 260 - 280 - 300)

8 + (2 hose reels
 S. 250 - 260 - 280 - 300)

1 - 1,035
 228

1 - 1,035
 276

268,5 - 145,2 - 50,5

268,5 - 250,3 - 50,5

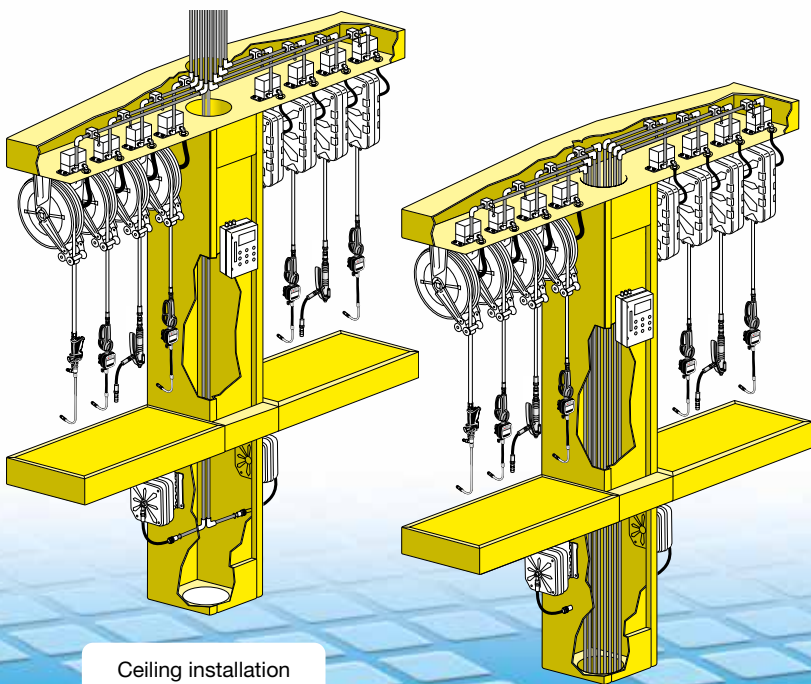

Ceiling installation

Floor installation





FRONTAL/BILATERAL service columns

Frontal, bilateral service column or with containment tank.

Ideal service stations for rationalising the areas dedicated to delivery. Able to collect any leaks or accidental spills, by means of the containment tanks, in compliance with the new regulations. Installable on walls, they are real independent operational stations. Made from top quality materials, with scratchproof painting.

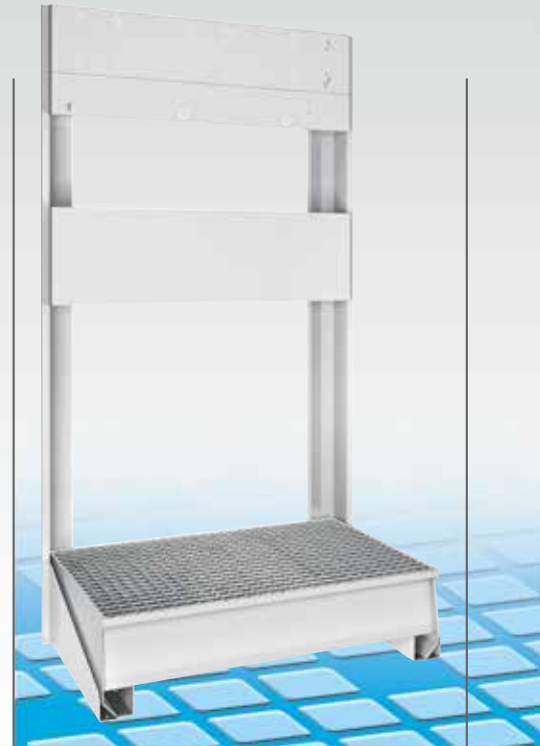
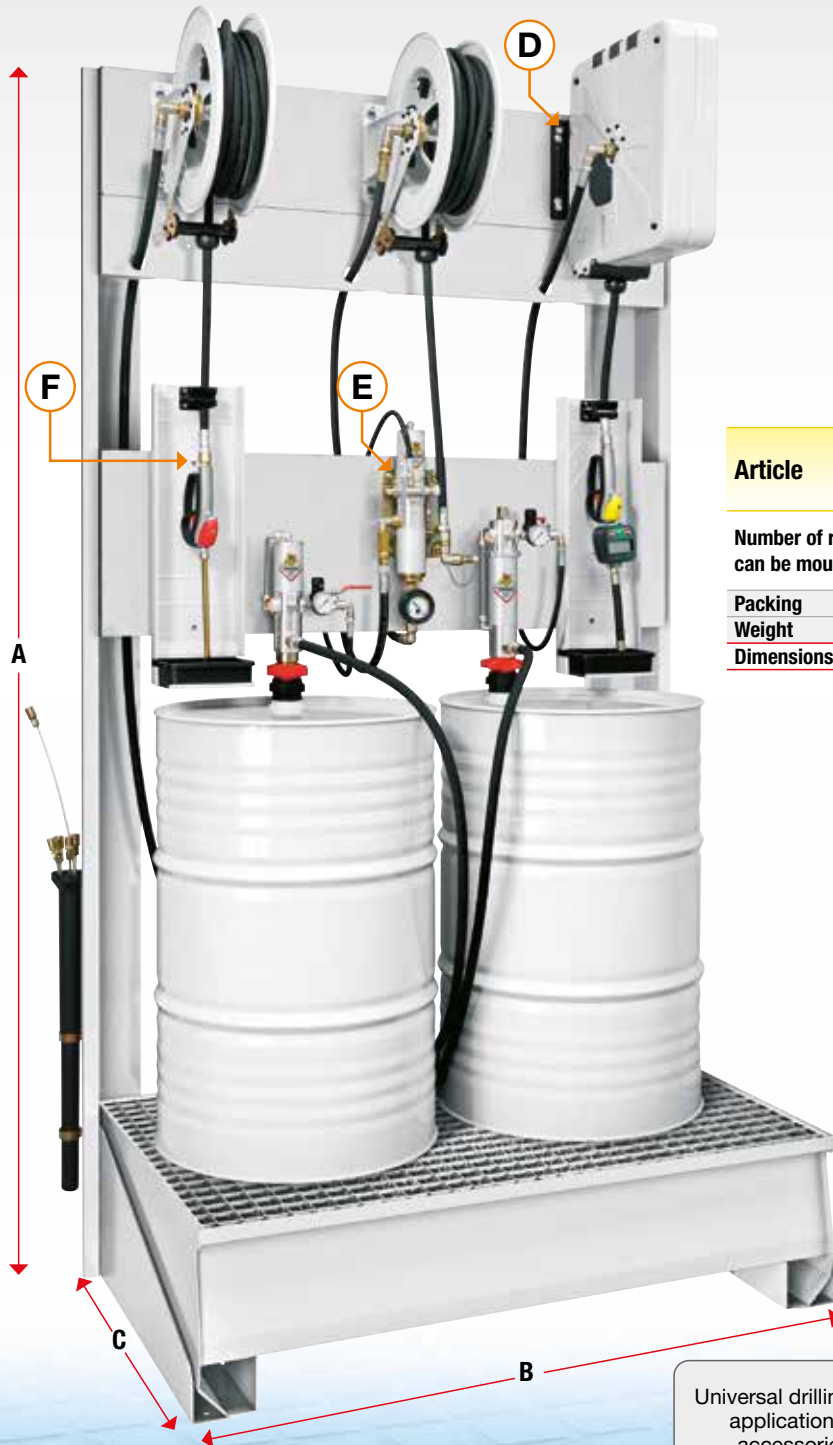

Article	39351	39352
Number of reels can be mounted	2 hose reels + 1 drum 180-220 kg	3 hose reels + 2 drums 180-220 kg
Packing N° - m ³	2 - 1,080	2 - 1,120
Weight kg	161	183,5
Dimensions (A - B - C) cm	260 - 110 - 89,5	260 - 145 - 89,5

Art. 39901
Containment tank 1 drum 180 - 220 kg (capacity 197 litre)

N°1 packing m³ 0,525 kg 51

Art. 39902
Containment tank 2 drum 180 - 220 kg (capacity 266 litre)

N°1 packing m³ 0,670 kg 64,5

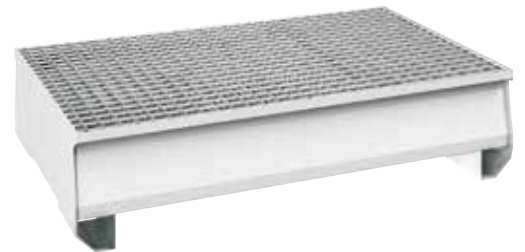

Details and advantages

Universal drillings for application of accessories

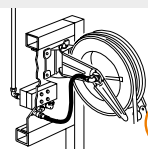

D

Holes for application of alternative pump

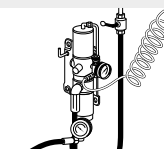

E

Holes for drip tray

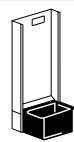

F

Accessories for Art. 39314 - 39317



Art. 39405
PC holder for service columns

📦 N°1 packing m³ 0,019

📦 kg 3,6

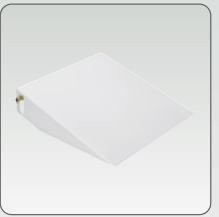

Art. 39406
Paper holder for service columns

📦 N°1 packing m³ 0,044

📦 kg 3,3

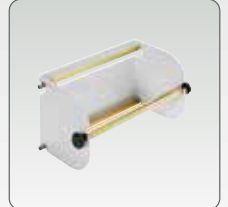

Art. 39407
Basket for service columns

📦 N°1 packing m³ 0,044

📦 kg 3,9

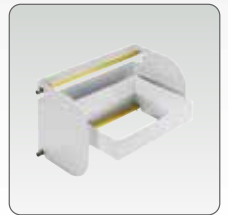

39304	39307	39314	39317
4	6	4 + (2 hose reels S. 250 - 260 - 280 - 300)	6 + (2 hose reels S. 250 - 260 - 280 - 300)
1 - 0,520	1 - 0,650	1 - 0,770	1 - 1,245
136	166	265	305
234 - 107 - 48,5	234 - 155 - 48,5	264 - 129 - 60	264 - 177 - 60

Details and advantages

Universal drillings for application of accessories

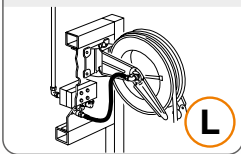

Delivery gun-hose hook

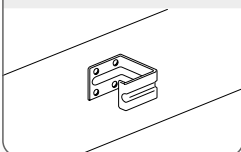

Drip-tray

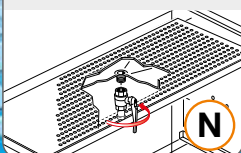

Details and advantages

Universal drillings for application of accessories

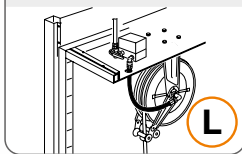

Arrangement for fixing the fluids control system

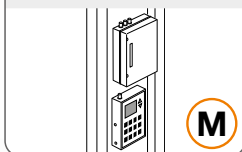

Drip-tray

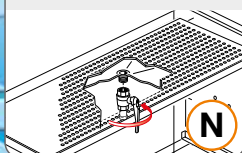



RAASM HOSE REELS

FLUIDS AND LUBRICATION EQUIPMENT



INDUSTRIAL HOSE REELS



Index hose reels

INTRODUCTION, ADVANTAGES AND CHOOSING A HOSE REELS

page 144

ENCLOSED IN SHOCK RESISTANT TECHNOPOLIMER SERIES 260



AIR-WATER 20 BAR

page 148

OPEN - HOSE POLYURETHANE



AIR-WATER 20 BAR

page 149

ENCLOSED IN PAINTED STEEL SERIES 450 - 440



AIR-WATER 20 BAR

page 150

OIL AND SIMILAR PRODUCTS 150 BAR

page 150

GREASE 400 BAR

page 150

ENCLOSED AND OPEN WITH DRUM IN ABS SHOCK PROOF



AIR-WATER 20 BAR

page 151

WATER MAX 130 °C 100 BAR

page 151

WATER MAX 130 °C 200 BAR

page 151

OIL AND SIMILAR PRODUCTS 150 BAR

page 151

GREASE 400 BAR

page 151

OPEN - AIR-WATER - PAINTED OR STAINLESS STEEL



AIR-WATER 20 BAR

page 154

WATER MAX 130 °C 100 BAR

page 156

WATER MAX 130 °C 200 BAR

page 158

WATER MAX 130 °C 400 BAR

page 160

OPEN - STAINLESS STEEL AISI 304



WATER MAX 130 °C 100 BAR

page 162

WATER MAX 130 °C 200 BAR

page 162

WATER MAX 130 °C 400 BAR

page 162

OPEN - STAINLESS STEEL AISI 316



WATER MAX 130 °C 100 BAR

page 163

OPEN - OIL, GREASE AND ALLIED PRODUCTS - PAINTED OR STAINLESS STEEL



OIL AND SIMILAR PRODUCTS 150 BAR

page 164

GREASE 400 BAR

page 166

OPEN - DIESEL FUEL AND ADBLUE® IN PAINTED OR STAINLESS STEEL



DIESEL FUEL 10 BAR page 168

ADBLUE® 10 BAR page 170

OPEN - DOUBLE INLET AND OUTLET - PAINTED STEEL



AIR-WATER 20 BAR page 171

OIL-WATER 200 BAR page 171

OIL-PAINT 150 BAR page 171

OIL 400 BAR page 171

OPEN - OXYACETYLENE WELDING AND LPG-METHANE - PAINTED STEEL

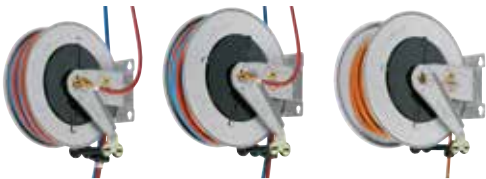

WELDING 20 BAR page 172

LPG-METHANE 20 BAR page 173

PNEUMATIC OR HYDRAULIC MOTOR OPERATED INDUSTRIAL SERIES - PAINTED STEEL



AIR-WATER 20 BAR page 174

WATER MAX 130 °C 100 BAR page 174

OIL AND SIMILAR PRODUCTS 150 BAR page 174

GREASE 400 BAR page 174

DIESEL FUEL 10 BAR page 174

SERIES 500 - MANUAL - PAINTED STEEL



AIR-WATER 20 BAR page 176

WATER MAX 130 °C 100 BAR page 176

WATER MAX 130 °C 200 BAR page 176

WATER MAX 130 °C 400 BAR page 176

OIL AND SIMILAR PRODUCTS 150 BAR page 176

DIESEL FUEL 10 BAR page 176

GROUNDING CABLE REELS_z - PAINTED STEEL



GROUNDING CABLE REELS page 177

SERIES 700 MOTOR DRIVEN AND MANUAL OPERATED - PAINTED STEEL



SERIES 700 (CATALOGUE N. 220/700) page 178



ACCESSORIES - HOSES page 180

7



RAASM introduces his wide range of hose reels

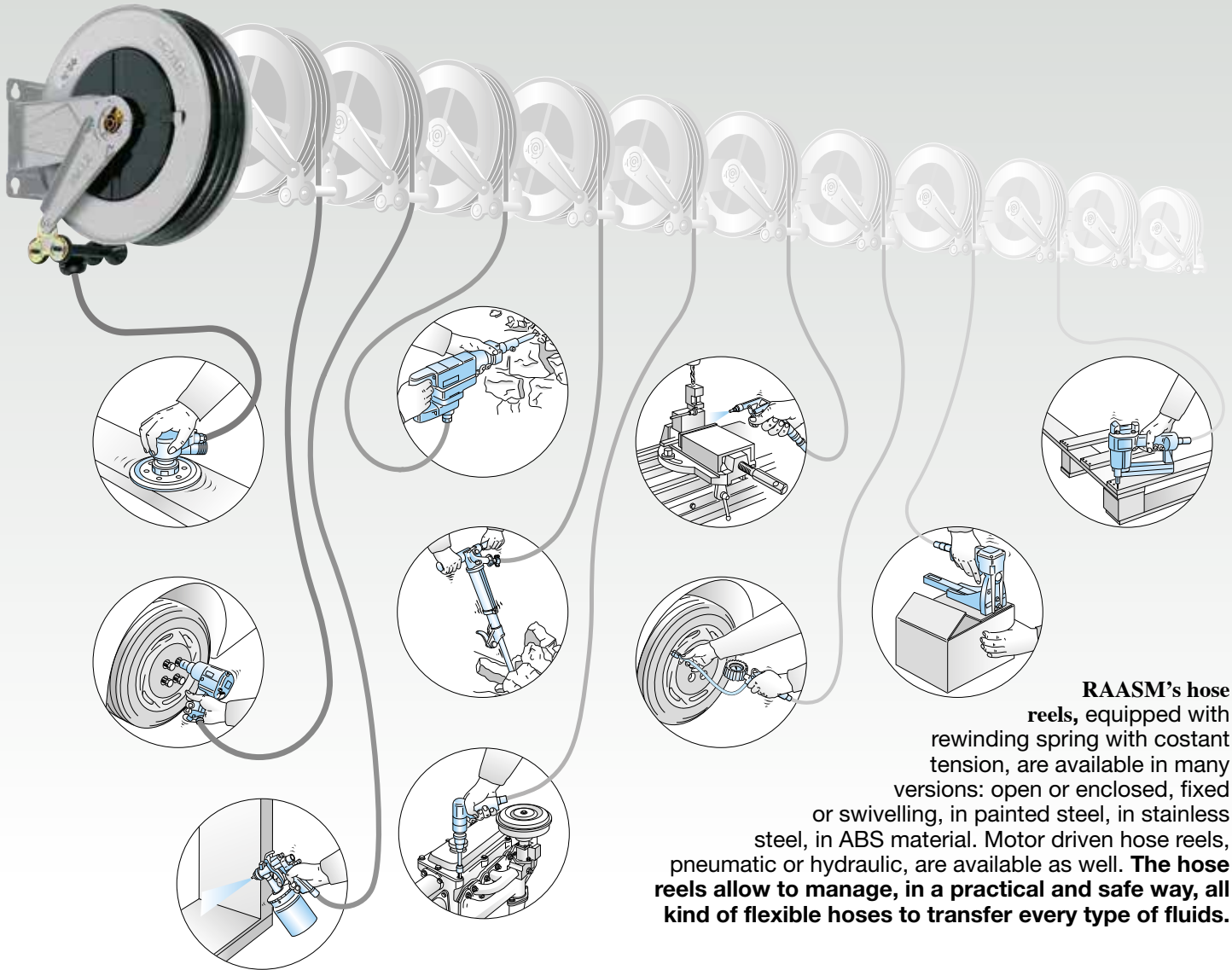

RAASM's hose reels, equipped with rewinding spring with constant tension, are available in many versions: open or enclosed, fixed or swivelling, in painted steel, in stainless steel, in ABS material. Motor driven hose reels, pneumatic or hydraulic, are available as well. **The hose reels allow to manage, in a practical and safe way, all kind of flexible hoses to transfer every type of fluids.**

HOSE REELS ADVANTAGES



ACCIDENT

The hose reels allows workers to operate in a safe workplace, using equipment always ready for use.



BREAK

The hose reels safeguards against wear and possible breakage of the hoses themselves.



DISORDER

With the hose reels, hose rewinding is quick and safe, for an orderly workplace.

Choosing a hose reels

When choosing a hose reels, it is important to consider the following aspects:

TYPE OF FLUID TO BE DELIVERED	FLOWRATE IN L/MIN TO BE DELIVERED	LENGTH AND DIAMETER OF HOSE TO BE USED	PRESSURE OF FLUID
-------------------------------	-----------------------------------	--	-------------------

TYPE OF FLUID TO BE DELIVERED AND PRESSURE OF FLUID

Air - Water 20 bar	AdBlue® 10 bar
Water max 130 °C 100 bar	Air - Water 20 bar
Water max 130 °C 200 bar	Oil - Water 200 bar
Water max 130 °C 400 bar	Oil - Paint 150 bar
Oil and similar products 150 bar	Oil 400 bar
Grease 400 bar	Welding 20 bar
Diesel fuel 10 bar	LPG - methane 20 bar

HOSE LENGTH AND DIAMETER

external diameter of hose	HOSE REELS SERIES									
	290	330	380 - 390	420 - 430	440 - 450	520 - 530	540 - 550	560	617 - 618	637 - 638
ø 12 mm	max. length 16 m	max. length 18 m	max. length 22 m	-	-	-	-	-	-	-
ø 14 mm	max. length 14 m	max. length 16 m	max. length 20 m	-	-	-	-	-	-	-
ø 17 mm	max. length 10 m	max. length 12 m	max. length 18 m	max. length 21 m	max. length 21 m	max. length 28 m	-	-	-	-
ø 19,5 mm	-	-	-	max. length 16 m	max. length 16 m	max. length 26 m	-	-	-	-
ø 22 mm	-	-	-	max. length 14 m	max. length 14 m	max. length 24 m	max. length 30 m	max. length 60 m	max. length 50 m	max. length 100 m
ø 28 mm	-	-	-	-	-	-	max. length 22 m	max. length 40 m	max. length 30 m	max. length 60 m
ø 34 mm	-	-	-	-	-	-	max. length 17 m	max. length 30 m	max. length 20 m	max. length 40 m
ø 44 mm	-	-	-	-	-	-	-	-	max. length 15 m	max. length 30 m
ø 50 mm	-	-	-	-	-	-	-	-	max. length 10 m	max. length 20 m
ø 13 + 13 mm	-	-	-	max. length 13 m	-	max. length 22 m	max. length 37 m	-	-	-
ø 15 + 15 mm	-	-	-	max. length 12 m	-	max. length 20 m	max. length 35 m	-	-	-
ø 16 + 16 mm	-	-	-	max. length 10 m	-	max. length 15 m	max. length 27 m	-	-	-

HOSE STOP

Adapters for hoses of different diameter (supplied with the hose stop)

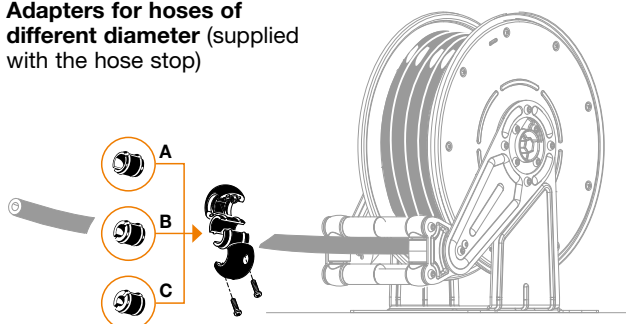

Universal hose stop comes with all hose reels supplied without hose, complete with adapters for using hoses of different diameter.

Article	Hose reels series		ø Reductions
KR7201	290 - 330 380 - 390	Painted - S. steel	12 - 14 - 16 mm
KR8104	420 - 430 - 440 450 - 520 - 530	Painted - S. steel	14 - 17 - 19 mm
KR8705	540 - 550 - 560	Painted - S. steel	14 - 17,5 - 21 28,5 - 30 - 34 mm
KR8907	420 - 520 - 540	Double hose	12 - 14 - 15 - 16 mm



Technical characteristics

Corrosion proof: all the components are treated or painted for external use.
Easy to install anywhere: on wall, floor, ceiling, vehicles, etc.

Automatic stopping system: allows hose to be locked at the required length

Fluid conveyance joint

The wall bracket with bayonet hooking is easy to mount and allows to remove quickly the hose reels when necessary

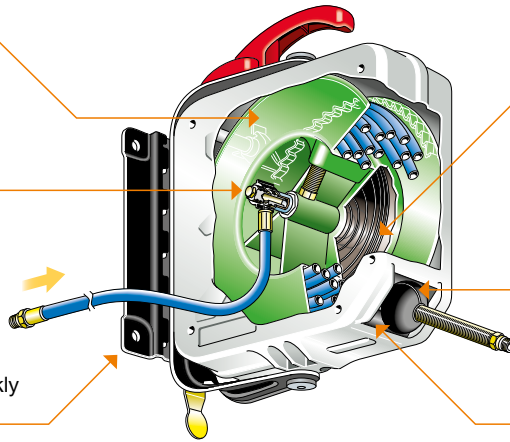

Rewinding spring

Adjustable hose stop

Self-lubricating hose guide rollers

Drum support bushings in self-lubricating material

The easy to install adjustable bracket allows the hose reels to be removed for any maintenance

The trip enables automatic stopping at the required length

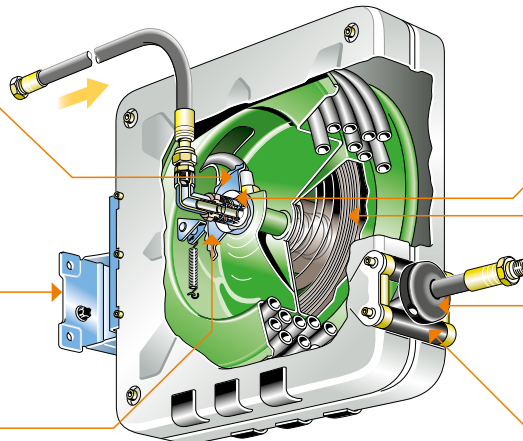

Fluid conveyance joint

Rewinding spring

Adjustable hose stop

Self-lubricating hose guide rollers

Automatic stopping system: allows the hose to be locked at the required length

Adjustable arm: to favour hose extraction according to hose reel installation

Self-lubricating hose guide rollers: wide multi-way opening

Adjustable hose stop

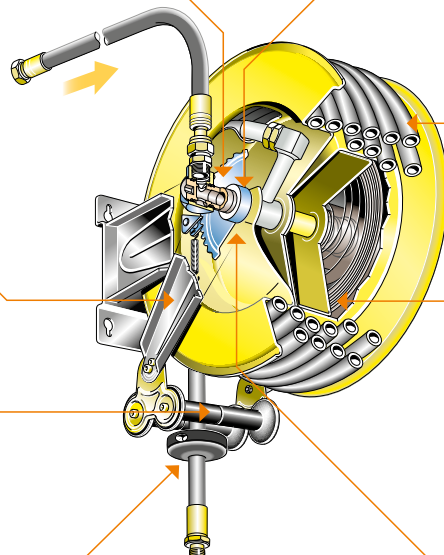

Drum support bushings in brass alloy, self-lubricating, effective and corrosion resistant

Hose reels drum: sturdy and practical with ribbing and rounded edges

Fully enclosed and protected constant-force automatic rewinding spring

Fluid passage swivel joint in brass / carbon steel / s/steel / AISI 304 s/steel with polyurethane / Viton® / Teflon® seals



Guide to reading the catalogue

1 Type of fluid to be delivered (water, air, oil, grease, other)

2 Pressure of fluid to be delivered linked to the feed pressure

3 Hose length the distance between the hose reels and the places where the fluid is to be delivered

4 Hose diameter on which the capacity of the hose itself depends

AIR / WATER - 20 bar PAINTED STEEL

FIXED



Article

8290.100

S. 290

8290.101

8290.104

SWIVELLING



Article

-

-

-

Supplied with:
- hoses in black synthetic
- galvanized steel fitting
- swivel in brass
- seals in "Viton®"

Hose supplied

without hose

10m - 3/8" (995.210)

15m - 1/4" (993.215)

without hose

12m - 3/8" (995.211)

A Stainless steel or painted this depends on the workplace (closed or open) and the type of hose reels use (protected or exposed to water sprays)

B Fixed or swivelling if the hose reels is used in a battery its operating range will be limited, therefore the fixed version is preferable. For uses requiring a greater operating range the swivelling version is recommended

C Open or enclosed the enclosed version is available only for the following fluids: air, oil and grease. The choice is up to the customer



HOSE REELS INSTALLATION

Example of installation: the adjustable arms can be easily repositioned according to needs

Standard installation

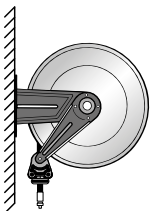

Wall installation

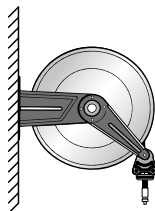

Bench installation

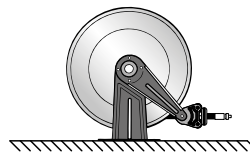

Ceiling installation

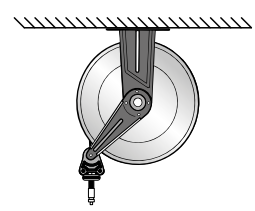

ACCESSORIES FOR HOSE REELS

Art. 88650

Latch mechanism
ABS protective cover
rack side for hose reels
series 420 - 430



Art. 88651

Latch mechanism
ABS protective cover
rack side for hose reels
series 520 - 530
540 - 550 - 560



Art. 88630

Modular drip-tray.
Equipped with hook
for gun and removable
drip-tray.
Applied under the
hose reels, it is a
handy holder for the
delivery gun.
Essential for a clean
and orderly workplace.





AIR-WATER - 20 bar

Series 260

Series 260



SWIVELLING wall support with BAYONET hooking

SWIVELLING SIMPLE wall support

Article	Hose supplied	Connection	
		inlet	outlet
89010	11m - 8x12 (971.111)	M1/4"G	M1/4"G
89011	11m - 6x10 (971.011)	M1/4"G	M1/4"G

Article	Hose supplied	Connection	
		inlet	outlet
89109	11m - 8x12 (971.111)	M1/4"G	M1/4"G
89110	11m - 6x10 (971.011)	M1/4"G	M1/4"G

OVERALL DIMENSIONS

OVERALL DIMENSIONS

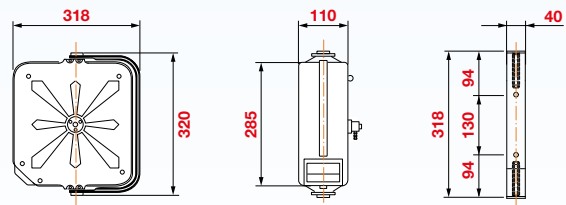
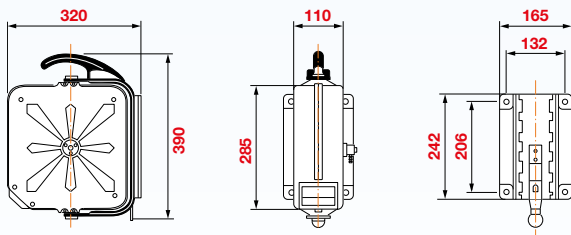

To prevent removal or theft of the hose reels, it can be secured with a bolt or padlock (not supplied).

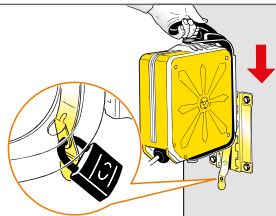

- Supplied with
- polyurethane hose
 - brass fitting
 - brass swivel joint
 - "Viton®" seals



Art. 89001

Series 260 hose reels are equipped with a **wall bracket with bayonet hooking**. The placing of several brackets in the service points allows the hose reels to be easily moved to the various workstations.

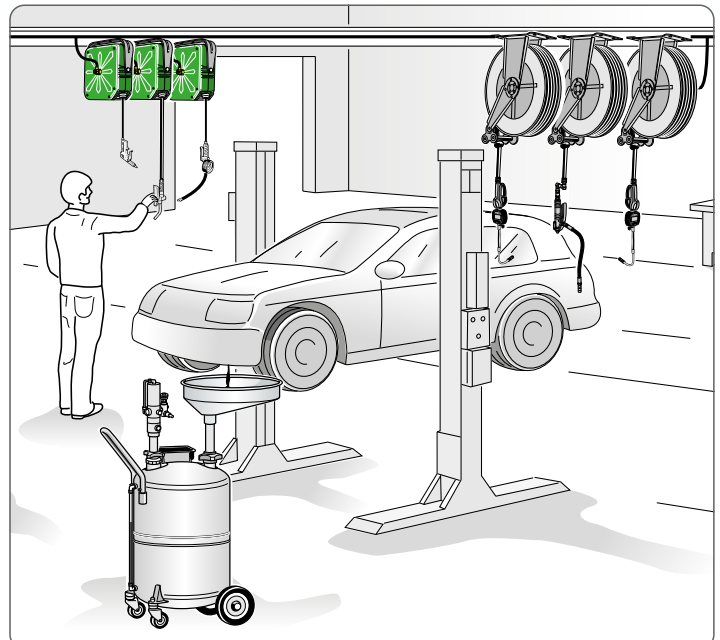
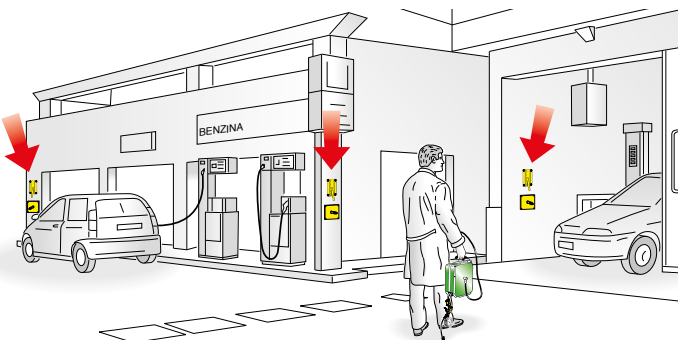



AIR-WATER - 20 bar

PAINTED STEEL

Ex ATEX directive II 3 GD c X

Supplied with:
 - polyurethane hose
 - brass fitting
 - brass swivel joint
 - "Viton®" seals



S. 288

Article	Hose supplied	Connection	
		inlet	outlet
8288.100	without hose	M3/8"G	F3/8"G
8288.102	13m - 10x14,5 (972.113)	M3/8"G	M3/8"G
8288.103	15m - 8x12 (971.115)	M3/8"G	M1/4"G
8288.104	10m - 6x10 (971.010)	M3/8"G	M1/4"G
8288.105	15m - 6x10 (971.015)	M3/8"G	M1/4"G

S. 328

8328.100	without hose	M3/8"G	F3/8"G
8328.102	15m - 10x14,5 (972.115)	M3/8"G	M3/8"G
8328.103	18m - 8x12 (971.118)	M3/8"G	M1/4"G
8328.104	8m - 13x19 (976.108)	M1/2"G	M1/2"G
8328.105	12m - 13x19 (976.112)	M1/2"G	M1/2"G

S. 378

8378.100	without hose	M3/8"G	F3/8"G
8378.102	20m - 10x14,5 (972.120)	M3/8"G	M3/8"G
8378.103	20m - 8x12 (971.120)	M3/8"G	M1/4"G
8378.104	10m - 13x19 (976.110)	M1/2"G	M1/2"G
8378.105	15m - 13x19 (976.114)	M1/2"G	M1/2"G

S. 438

8430.100	without hose	F1/2"G	F1/2"G
8438.101	10m - 13x19 (976.111)	F1/2"G	M1/2"G
8438.102	15m - 13x19 (976.115)	F1/2"G	M1/2"G

FIXED OVERALL DIMENSIONS

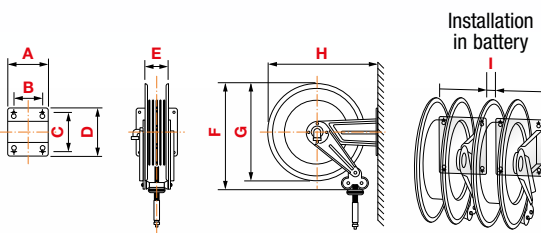

Art.	A	B	C	D	E	F	G	H	I	1-m ³	kg *
S. 288	186	140	196	226	110	310	300	320	-	0,037	from 7 to 12
S. 328	186	140	196	226	110	355	350	365	20	0,045	from 8 to 13
S. 378	186	140	196	226	110	400	390	410	20	0,068	from 10 to 17
S. 438	186	140	196	226	115	450	420	460	20	0,098	from 14 to 21

* The list shows min and max weight for each series: min weight refers to version without hose, max weight refers to heaviest version which depends on hose length and diameter.

FIXED HOSE REELS INSTALLATION

The quick coupling support is equipped with 4 slot holes that allow an easy and safe installation of the hose reels. The **template** supplied facilitates drilling of the holes and there fore hose reels fixing.

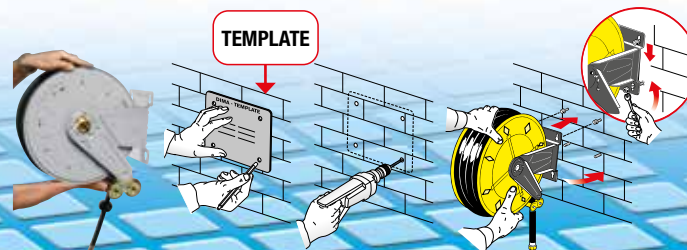



ENCLOSED IN PAINTED STEEL

Series 450

Series 440



ATEX directive
IIB 2 GD c T4 T135 °C X
o II 3 GD c X (20 bar)



Supplied with:
- hoses in black synthetic rubber
- zinc plated steel couplings



FIXED support
Article

SWIVELLING support
Article

Hose supplied	Connection	
	inlet	outlet

Air - Water 20 bar
- bras swivel joint
- "Viton®" seals

8450.100
8450.101
8450.102
8450.103
8450.104

8440.100
8440.101
8440.102
8440.103
8440.104

without hose	F1/2"G	F1/2"G
12m - 3/8" (995.212)	F1/2"G	M3/8"G
18m - 3/8" (995.218)	F1/2"G	M3/8"G
10m - 1/2" (996.210)	F1/2"G	M1/2"G
15m - 1/2" (996.215)	F1/2"G	M1/2"G

Oil and similar products 150 bar
- carbon steel swivel joint
- "polyurethane" seals

8450.400
8450.401
8450.402

8440.400
8440.401
8440.402

without hose	F1/2"G	F1/2"G
10m - 1/2" (996.310)	F1/2"G	M1/2"G
15m - 1/2" (996.315)	F1/2"G	M1/2"G

Grease 400 bar
- carbon steel swivel joint
- "polyurethane" seals

8450.500 *
8450.501
8450.502
8450.505
8450.506

8440.500 *
8440.501
8440.502
8440.505
8440.506

without hose	F3/8"G	F1/2"G
12m - 1/4" (993.512)	F3/8"G	M1/4"G
18m - 1/4" (993.518)	F3/8"G	M1/4"G
10m - 3/8" (995.710)	F3/8"G	M1/4"G
15m - 3/8" (995.715)	F3/8"G	M1/4"G

* 600 bar

* 600 bar

FIXED OVERALL DIMENSIONS

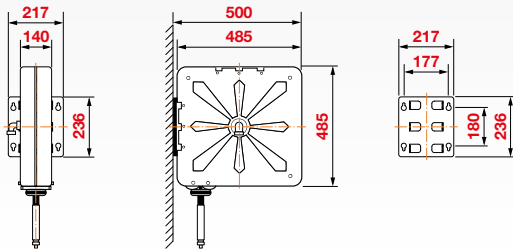

1 N°1 packing m³ 0,111 1 from 21 to 29 kg

SWIVELLING OVERALL DIMENSIONS

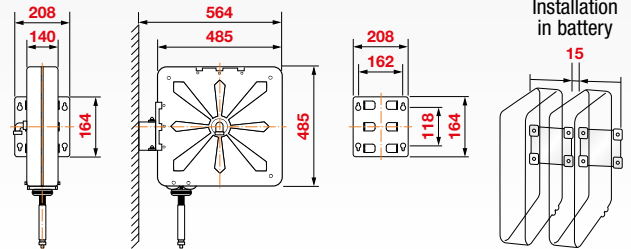

1 N°1 packing m³ 0,111 1 from 22 to 30 kg

FIXED HOSE REELS INSTALLATION

The quick coupling support is equipped with 4 slot holes that allow an easy and safe installation of the hose reels.
The **template** supplied facilitates drilling of the holes and there fore hose reels fixing.

SWIVELLING HOSE REELS INSTALLATION

The **quick coupling swivelling support** facilitates hose reels installation and enables **55° rotation** to the right or left or locking in **fixed positioned at 0°** by means of clamping with two screws.

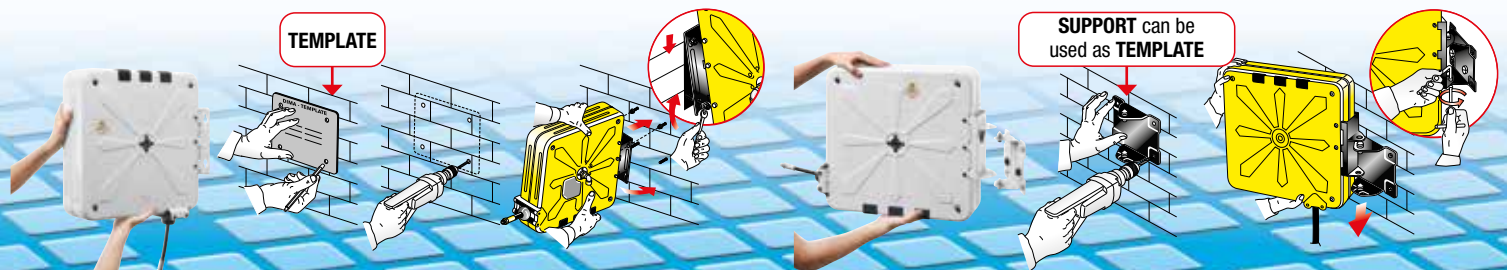



ENCLOSED IN PAINTED STEEL with **ABS** spool

Series 450

cover in painted steel

ABS shock proof drum



Supplied with:
- hoses in black synthetic rubber
- zinc plated steel couplings



Ex ATEX directive II 3 GD c X

Article

Hose supplied	Connection	
	inlet	outlet

Air - Water 20 bar
- bras swivel joint
- "Viton®" seals

9450.100
9450.101
9450.102
9450.103
9450.104

without hose	F1/2"G	F1/2"G
12m - 3/8" (995.212)	F1/2"G	M3/8"G
18m - 3/8" (995.218)	F1/2"G	M3/8"G
10m - 1/2" (996.210)	F1/2"G	M1/2"G
15m - 1/2" (996.215)	F1/2"G	M1/2"G

Oil and similar products 150 bar
- carbon steel swivel joint
- "polyurethane" seals

9450.400
9450.401
9450.402

without hose	F1/2"G	F1/2"G
10m - 1/2" (996.310)	F1/2"G	M1/2"G
15m - 1/2" (996.315)	F1/2"G	M1/2"G

Grease 400 bar
- carbon steel swivel joint
- "polyurethane" seals

9450.500 *
9450.501
9450.502
9450.505
9450.506

without hose	F3/8"G	F1/2"G
12m - 1/4" (993.512)	F3/8"G	M1/4"G
18m - 1/4" (993.518)	F3/8"G	M1/4"G
10m - 3/8" (995.710)	F3/8"G	M1/4"G
15m - 3/8" (995.715)	F3/8"G	M1/4"G

* 600 bar

FIXED OVERALL DIMENSIONS

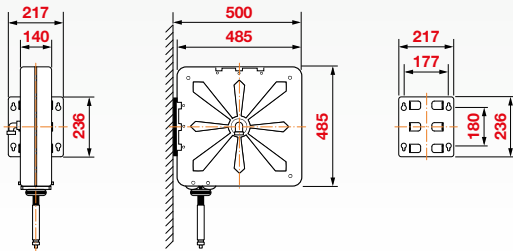

N°1 packing m³ 0,111 from 20 to 29 kg

FIXED HOSE REELS INSTALLATION

The quick coupling support is equipped with 4 slot holes that allow an easy and safe installation of the hose reels.
The **template** supplied facilitates drilling of the holes and there fore hose reels fixing.

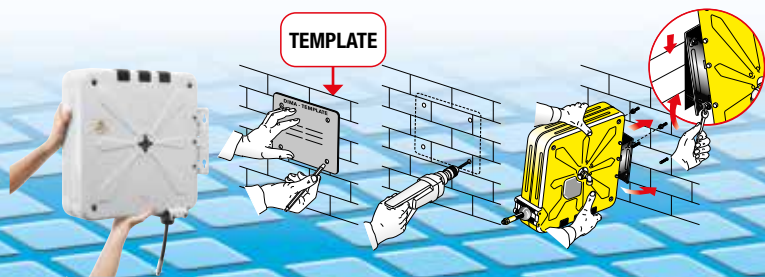

HOSE REELS INSTALLATION

Example of installation: the hose reels can be easily repositioned according to needs

Standard installation

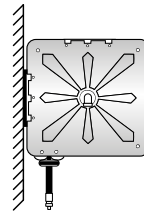

Wall installation

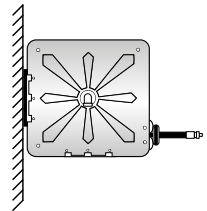

Bench installation

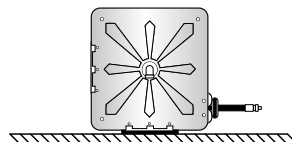

Ceiling installation

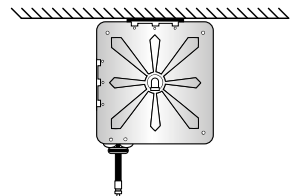



PAINTED STEEL with ABS drum

Series 430

Painted steel bracket

ABS shock proof drum



Supplied with:
- hoses in black synthetic rubber
- zinc plated steel couplings



	FIXED support		Connection	
	Article		inlet	outlet
Air - Water 20 bar - bras swivel joint - "Viton®" seals	9430.100	without hose	F1/2"G	F1/2"G
	9430.101	12m - 3/8" (995.212)	F1/2"G	M3/8"G
	9430.102	18m - 3/8" (995.218)	F1/2"G	M3/8"G
	9430.103	10m - 1/2" (996.210)	F1/2"G	M1/2"G
	9430.104	15m - 1/2" (996.215)	F1/2"G	M1/2"G
Water max 130 °C 100 bar - AISI 304 stainless steel swivel joint - "Viton®" seals	9430.200	without hose	F1/2"G	F1/2"G
	9430.201	10m - 1/2" (996.311)	F1/2"G	M1/2"G
	9430.202	15m - 1/2" (996.316)	F1/2"G	M1/2"G
	hygienic hose 9431.202	15m - 1/2" (996.415)	F1/2"G	M1/2"G
Water max 130 °C 200 bar - AISI 304 stainless steel swivel joint - "Viton®" seals	9430.300	without hose	F3/8"G	F1/2"G
	9430.301	12m - 3/8" (995.512)	F3/8"G	F3/8"G
	9430.302	18m - 3/8" (995.518)	F3/8"G	F3/8"G
	hygienic hose 9431.302	18m - 3/8" (995.618)	F3/8"G	F3/8"G
Oil and similar products 150 bar - carbon steel swivel joint - "polyurethane" seals	9430.400	without hose	F1/2"G	F1/2"G
	9430.401	10m - 1/2" (996.310)	F1/2"G	M1/2"G
	9430.402	15m - 1/2" (996.315)	F1/2"G	M1/2"G
Grease 400 bar - carbon steel swivel joint - "polyurethane" seals	9430.500 *	without hose	F3/8"G	F1/2"G
	9430.501	12m - 1/4" (993.512)	F3/8"G	M1/4"G
	9430.502	18m - 1/4" (993.518)	F3/8"G	M1/4"G
	9430.505	10m - 3/8" (995.710)	F3/8"G	M1/4"G
	9430.506	15m - 3/8" (995.715)	F3/8"G	M1/4"G

* 600 bar

FIXED OVERALL DIMENSIONS

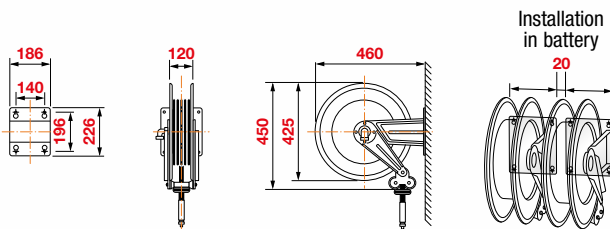

N°1 packing m³ 0,098 from 14 to 24 kg

FIXED HOSE REELS INSTALLATION

The quick coupling support is equipped with 4 slot holes that allow an easy and safe installation of the hose reels.
The **template** supplied facilitates drilling of the holes and there fore hose reels fixing.

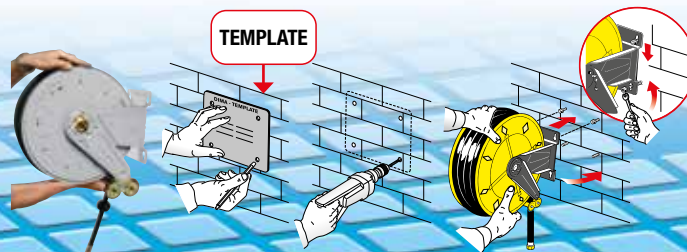



STAINLESS STEEL with ABS drum

Series 430

AISI 304 stainless steel bracket

Ex ATEX directive II 3 GD c X



ABS shock proof drum

Supplied with:
- hoses in black synthetic rubber
- zinc plated steel couplings



	FIXED support		Connection		
	Article		Hose supplied	inlet	outlet
Air - Water 20 bar - bras swivel joint - "Viton®" seals		9432.100	without hose	F1/2"G	F1/2"G
		9432.101	12m - 3/8" (995.212)	F1/2"G	M3/8"G
		9432.102	18m - 3/8" (995.218)	F1/2"G	M3/8"G
		9432.103	10m - 1/2" (996.210)	F1/2"G	M1/2"G
		9432.104	15m - 1/2" (996.215)	F1/2"G	M1/2"G
Water max 130 °C 100 bar - AISI 304 stainless steel swivel joint - "Viton®" seals		9434.200	without hose	F1/2"G	F1/2"G
		9432.201	10m - 1/2" (996.311)	F1/2"G	M1/2"G
		9432.202	15m - 1/2" (996.316)	F1/2"G	M1/2"G
	hygienic hose	9433.202	15m - 1/2" (996.415)	F1/2"G	M1/2"G
Water max 130 °C 200 bar - AISI 304 stainless steel swivel joint - "Viton®" seals		9434.300	without hose	F3/8"G	F1/2"G
		9432.301	12m - 3/8" (995.512)	F3/8"G	F3/8"G
		9432.302	18m - 3/8" (995.518)	F3/8"G	F3/8"G
	hygienic hose	9433.302	18m - 3/8" (995.618)	F3/8"G	F3/8"G
Oil and similar products 150 bar - AISI 304 stainless steel swivel joint - "Viton®" seals		9434.200	without hose	F1/2"G	F1/2"G
		9432.401	10m - 1/2" (996.310)	F1/2"G	M1/2"G
		9432.402	15m - 1/2" (996.315)	F1/2"G	M1/2"G
Grease 400 bar - carbon steel swivel joint - "polyurethane" seals		9432.500 *	without hose	F3/8"G	F1/2"G
		9432.501	12m - 1/4" (993.512)	F3/8"G	M1/4"G
		9432.502	18m - 1/4" (993.518)	F3/8"G	M1/4"G
		9432.505	10m - 3/8" (995.710)	F3/8"G	M1/4"G
		9432.506	15m - 3/8" (995.715)	F3/8"G	M1/4"G

* 600 bar

FIXED OVERALL DIMENSIONS

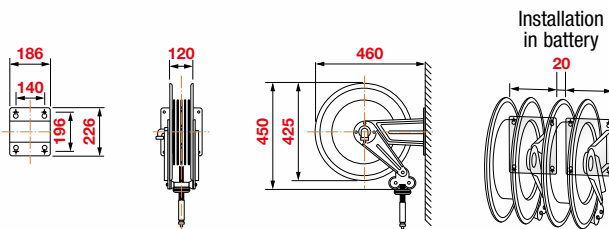

N°1 packing m³ 0,098 from 14 to 24 kg

FIXED HOSE REELS INSTALLATION

The quick coupling support is equipped with 4 slot holes that allow an easy and safe installation of the hose reels.
The **template** supplied facilitates drilling of the holes and there fore hose reels fixing.

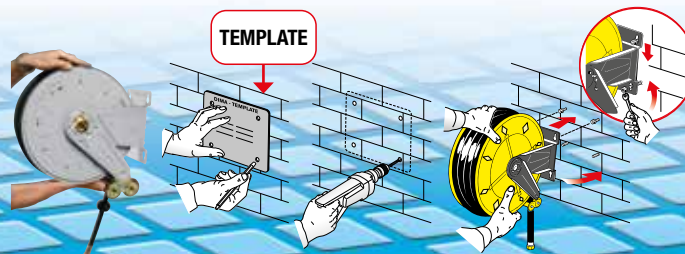



AIR-WATER - 20 bar

PAINTED STEEL

Ex ATEX directive II 3 GD c X

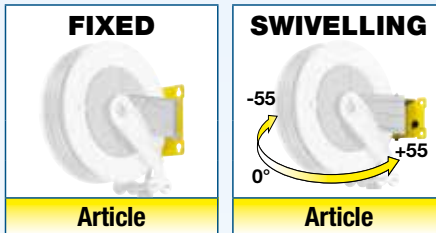

Supplied with:

- hoses in black synthetic rubber
- zinc plated steel couplings
- brass swivel joint
- "Viton®" seals



	Article	Article	Hose supplied	Connection	
				inlet	outlet
S. 290	8290.100	-	without hose	F3/8"G	F3/8"G
	8290.101	-	10m - 3/8" (995.210)	F3/8"G	M3/8"G
	8290.104	-	15m - 1/4" (993.215)	F3/8"G	M1/4"G
S. 330	8330.100	-	without hose	F3/8"G	F3/8"G
	8330.101	-	12m - 3/8" (995.211)	F3/8"G	M3/8"G
S. 390	8390.100	8380.100	without hose	F3/8"G	F3/8"G
	8390.102	8380.102	18m - 3/8" (995.217)	F3/8"G	M3/8"G
S. 430	8430.100	8420.100	without hose	F1/2"G	F1/2"G
	8430.101	8420.101	12m - 3/8" (995.212)	F1/2"G	M3/8"G
	8430.102	8420.102	18m - 3/8" (995.218)	F1/2"G	M3/8"G
	8430.103	8420.103	10m - 1/2" (996.210)	F1/2"G	M1/2"G
	8430.104	8420.104	15m - 1/2" (996.215)	F1/2"G	M1/2"G
for ABS hose reels Series 430 see page 152					
S. 530	8530.100	8520.100	without hose	F1/2"G	F1/2"G
	8530.101	8520.101	20m - 1/2" (996.220)	F1/2"G	M1/2"G
	8530.102	8520.102	25m - 1/2" (996.225)	F1/2"G	M1/2"G
S. 540	8540.100	8550.100	without hose	F1"G	F1"G
	8540.101	8550.101	15m - 3/4" (997.215)	F1"G	M3/4"G
	8540.102	8550.102	20m - 3/4" (997.220)	F1"G	M3/4"G
	8540.103	8550.103	15m - 1" (998.215)	F1"G	M1"G
	8540.105	8550.105	without hose	F1/2"G	F1/2"G
	8540.106	8550.106	30m - 1/2" (996.230)	F1/2"G	M1/2"G
S. 560	8560.100	-	without hose	F1"G	F1"G
	8560.101	-	30m - 3/4" (997.230)	F1"G	M3/4"G
	8560.103	-	40m - 3/4" (997.240)	F1"G	M3/4"G
	8560.104	-	20m - 1" (998.220)	F1"G	M1"G
	8560.105	-	30m - 1" (998.230)	F1"G	M1"G
	8560.106	-	without hose	F1/2"G	F1/2"G

FIXED HOSE REELS INSTALLATION

The quick coupling support is equipped with 4 slot holes that allow an easy and safe installation of the hose reels. The **template** supplied facilitates drilling of the holes and therefore hose reels fixing.

SWIVELLING HOSE REELS INSTALLATION

The **quick coupling swivelling support** facilitates hose reels installation and enables **55° rotation** to the right or left or locking in **fixed positioned at 0°** by means of clamping with two screws.

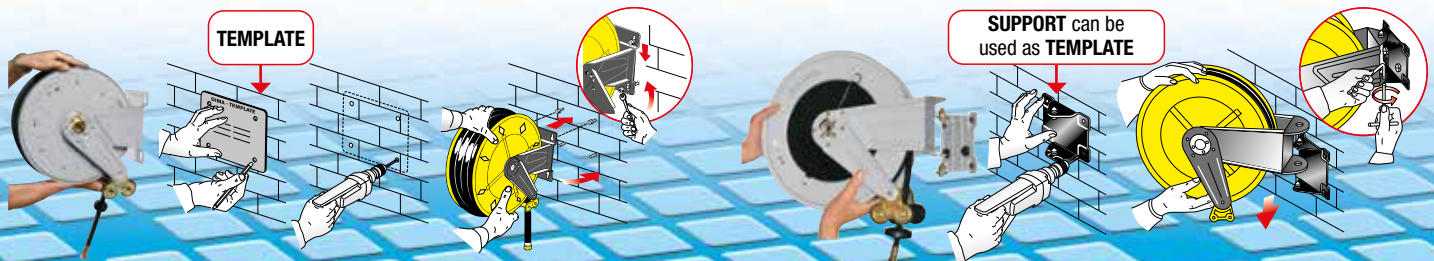



AIR-WATER - 20 bar

AISI 304 STAINLESS STEEL



FIXED

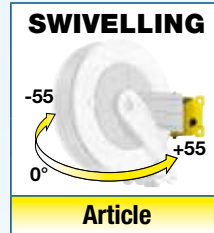

SWIVELLING

Supplied with:
 - hoses in black synthetic rubber
 - zinc plated steel couplings
 - brass swivel joint
 - "Viton®" seals



S. 290

S. 330

S. 390

S. 430

S. 530

S. 540

S. 560

Article	Article	Hose supplied	Connection	
			inlet	outlet
8292.100	-	without hose	F3/8"G	F3/8"G
8292.101	-	10m - 3/8" (995.210)	F3/8"G	M3/8"G
8292.104	-	15m - 1/4" (993.215)	F3/8"G	M1/4"G
8332.100	-	without hose	F3/8"G	F3/8"G
8332.101	-	12m - 3/8" (995.211)	F3/8"G	M3/8"G
8392.100	8382.100	without hose	F3/8"G	F3/8"G
8392.102	8382.102	18m - 3/8" (995.217)	F3/8"G	M3/8"G
8432.100	8422.100	without hose	F1/2"G	F1/2"G
8432.101	8422.101	12m - 3/8" (995.212)	F1/2"G	M3/8"G
8432.102	8422.102	18m - 3/8" (995.218)	F1/2"G	M3/8"G
8432.103	8422.103	10m - 1/2" (996.210)	F1/2"G	M1/2"G
8432.104	8422.104	15m - 1/2" (996.215)	F1/2"G	M1/2"G
for ABS hose reels Series 430 see page 153				
8532.100	8522.100	without hose	F1/2"G	F1/2"G
8532.101	8522.101	20m - 1/2" (996.220)	F1/2"G	M1/2"G
8532.102	8522.102	25m - 1/2" (996.225)	F1/2"G	M1/2"G
8542.100	8552.100	without hose	F1"G	F1"G
8542.101	8552.101	15m - 3/4" (997.215)	F1"G	M3/4"G
8542.102	8552.102	20m - 3/4" (997.220)	F1"G	M3/4"G
8542.103	8552.103	15m - 1" (998.215)	F1"G	M1"G
8542.105	8552.105	without hose	F1/2"G	F1/2"G
8542.106	8552.106	30m - 1/2" (996.230)	F1/2"G	M1/2"G
8562.100	-	without hose	F1"G	F1"G
8562.101	-	30m - 3/4" (997.230)	F1"G	M3/4"G
8562.103	-	40m - 3/4" (997.240)	F1"G	M3/4"G
8562.104	-	20m - 1" (998.220)	F1"G	M1"G
8562.105	-	30m - 1" (998.230)	F1"G	M1"G
8562.106	-	without hose	F1/2"G	F1/2"G

FIXED OVERALL DIMENSIONS

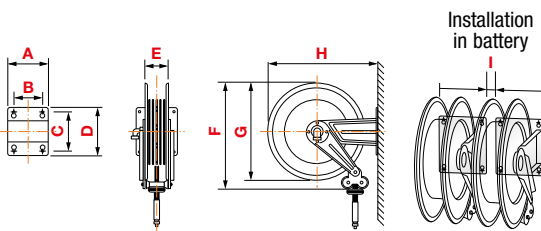

Art.	A	B	C	D	E	F	G	H	I	1-m ³	kg*
S. 290	186	140	196	226	110	310	300	320	-	0,037	from 7 to 12
S. 330	186	140	196	226	110	355	350	365	20	0,045	from 8 to 13
S. 390	186	140	196	226	110	400	390	410	20	0,068	from 11 to 18
S. 430	186	140	196	226	115	460	420	460	20	0,098	from 14 to 24
S. 530	203	153	220	258	115	550	510	560	20	0,120	from 19 to 42
S. 540	300	218	228	268	190	550	510	573	0	0,175	from 24 to 40
S. 560	488	399	238	272	368	550	510	578	0	0,310	from 30 to 80

SWIVELLING OVERALL DIMENSIONS

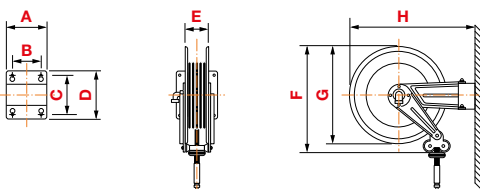

Art.	A	B	C	D	E	F	G	H	1-m ³	kg
S. 380	184	146	106	144	110	400	390	484	0,098	from 12 to 19
S. 420	208	162	118	164	115	460	420	541	0,098	from 15 to 25
S. 520	228	182	154	200	115	560	510	642	0,120	from 20 to 43
S. 550	300	218	226	268	190	560	510	702	0,175	from 25 to 41

* The list shows min and max weight for each series: min weight refers to version without hose, max weight refers to heaviest version which depends on hose length and diameter.



WATER MAX 130 °C* - 100 bar

PAINTED STEEL



ATEX directive
IIB 2 GD c T4 T135 °C X

Supplied with:

- hoses in black synthetic rubber
- zinc plated steel couplings
- AISI 304 stainless steel swivel joint
- "Viton®" seals



FIXED



SWIVELLING



	Article		Hose supplied	Connection	
	inlet	outlet		inlet	outlet
S. 330	8330.200	-	without hose	F1/2"G	F 3/8"-1/2"G
	8330.201	-	12m - 3/8" (995.313)	F1/2"G	M3/8"G
S. 390	8390.200	8380.200	without hose	F1/2"G	F3/8"-1/2"G
	8390.202	8380.202	17m - 3/8" (995.318)	F1/2"G	M3/8"G
S. 430	8430.200	8420.200	without hose	F1/2"G	F1/2"G
	8430.201	8420.201	10m - 1/2" (996.311)	F1/2"G	M1/2"G
	8430.202	8420.202	15m - 1/2" (996.316)	F1/2"G	M1/2"G
	for ABS hose reels Series 430 see page 152				
S. 530	8530.200	8520.200	without hose	F1/2"G	F1/2"G
	8530.201	8520.201	20m - 1/2" (996.321)	F1/2"G	M1/2"G
S. 540	8540.200	8550.200	without hose	F1"G	F1"G
	8540.202	8550.202	20m - 3/4" (997.320)	F1"G	M3/4"G
	8540.203 *	8550.203 *	15m - 1" (998.315)	F1"G	M1"G
S. 560	8560.200	-	without hose	F1"G	F1"G
	8560.205 *	-	30m - 1" (998.330)	F1"G	M1"G

* 50 bar

* 50 bar

* Effective temperature only for versions without hose. For the maximum temperature of the versions with hose, contact technical dept.

FIXED HOSE REELS INSTALLATION

The quick coupling support is equipped with 4 slot holes that allow an easy and safe installation of the hose reels. The **template** supplied facilitates drilling of the holes and therefore hose reels fixing.

SWIVELLING HOSE REELS INSTALLATION

The **quick coupling swivelling support** facilitates hose reels installation and enables **55° rotation** to the right or left or locking in **fixed positioned at 0°** by means of clamping with two screws.

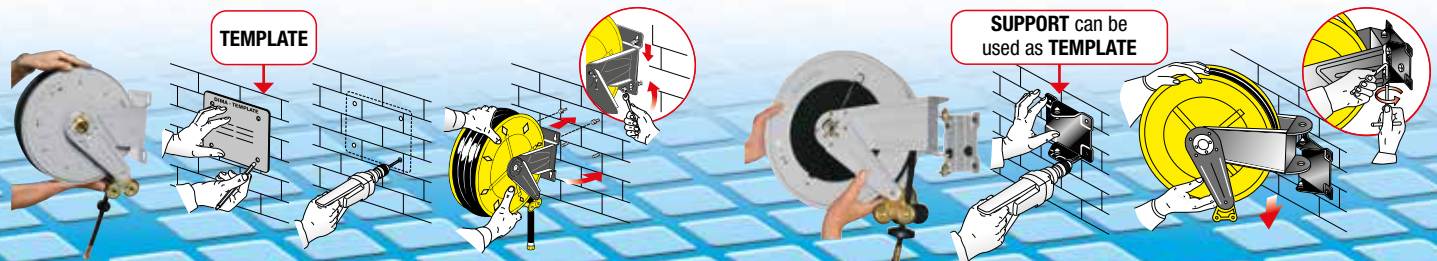



WATER MAX 130 °C* - 100 bar

AISI 304 STAINLESS STEEL



ATEX directive
IIB 2 GD c T4 T135 °C X

Supplied with:

- hoses in black synthetic rubber
- zinc plated steel couplings
- AISI 304 stainless steel swivel joint
- "Viton®" seals



FIXED

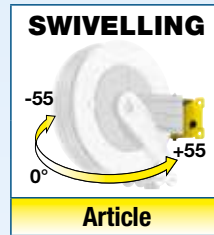

SWIVELLING

Article	Article	Hose supplied	Connection	
			inlet	outlet
S. 330	-	without hose	F1/2"G	F 3/8"-1/2"G
8332.201	-	12m - 3/8" (995.313)	F1/2"G	M3/8"G
8333.202	-	12m - 3/8" (995.412)	F1/2"G	M3/8"G
S. 390	8382.200	without hose	F1/2"G	F3/8"-1/2"G
8392.202	8382.202	17m - 3/8" (995.318)	F1/2"G	M3/8"G
8393.201	8383.201	12m - 3/8" (995.412)	F1/2"G	M3/8"G
S. 430	8424.200	without hose	F1/2"G	F1/2"G
8434.200	8422.201	10m - 1/2" (996.311)	F1/2"G	M1/2"G
8432.201	8422.202	15m - 1/2" (996.316)	F1/2"G	M1/2"G
8432.202	8423.202	15m - 1/2" (996.415)	F1/2"G	M1/2"G
8433.202				

for ABS hose reels Series 430 see page 153

S. 530	8524.200	without hose	F1/2"G	F1/2"G
8534.200	8522.201	20m - 1/2" (996.321)	F1/2"G	M1/2"G
8532.201	8523.202	25m - 1/2" (996.425)	F1/2"G	M1/2"G
S. 540	8554.200	without hose	F1"G	F1"G
8544.200	8552.202	20m - 3/4" (997.320)	F1"G	M3/4"G
8542.202	8552.203 *	15m - 1" (998.315)	F1"G	M1"G
8542.203 *	8553.202	20m - 3/4" (997.420)	F1"G	M3/4"G
8543.202				
S. 560	-	without hose	F1"G	F1"G
8564.200	-	30m - 1" (998.330)	F1"G	M1"G
8562.205 *	-			

* 50 bar

* 50 bar



* Effective temperature only for versions without hose. For the maximum temperature of the versions with hose, contact technical dept.

FIXED OVERALL DIMENSIONS

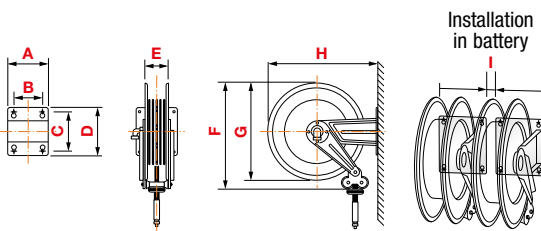

Art.	A	B	C	D	E	F	G	H	I	1-m ³	kg *
S. 330	186	140	196	226	110	355	350	365	20	0,045	from 8 to 13
S. 390	186	140	196	226	110	400	390	410	20	0,068	from 11 to 18
S. 430	186	140	196	226	115	460	420	460	20	0,098	from 14 to 24
S. 530	203	153	220	258	115	550	510	560	20	0,120	from 19 to 42
S. 540	300	218	228	268	190	550	510	573	0	0,175	from 24 to 40
S. 560	488	399	238	272	368	550	510	578	0	0,310	from 30 to 80

SWIVELLING OVERALL DIMENSIONS

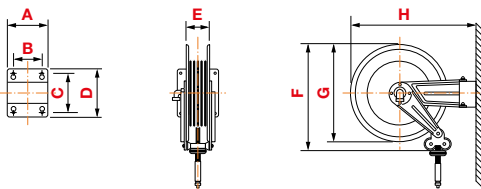

Art.	A	B	C	D	E	F	G	H	1-m ³	kg
S. 380	184	146	106	144	110	400	390	484	0,098	from 12 to 19
S. 420	208	162	118	164	115	460	420	541	0,098	from 15 to 25
S. 520	228	182	154	200	115	560	510	642	0,120	from 20 to 43
S. 550	300	218	226	268	190	560	510	702	0,175	from 25 to 41

* The list shows min and max weight for each series: min weight refers to version without hose, max weight refers to heaviest version which depends on hose length and diameter.



WATER MAX 130 °C - 200 bar

PAINTED STEEL



ATEX directive
IIB 2 GD c T4 T135 °C X

Supplied with:

- hoses in black synthetic rubber
- zinc plated steel couplings
- AISI 304 stainless steel swivel joint
- "Viton®" seals

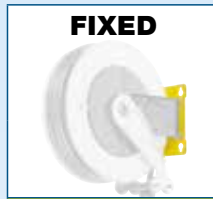

FIXED

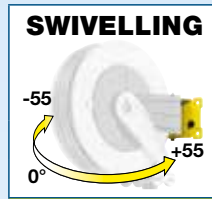

SWIVELLING



	Article		Hose supplied	Connection	
	inlet	outlet		inlet	outlet
S. 330	8330.300	-	without hose	F3/8"G	F3/8"G
	8330.301	-	12m - 5/16" (994.512)	F3/8"G	F3/8"G
S. 390	8390.300	8380.300	without hose	F3/8"G	F3/8"G
	8390.302	8380.302	17m - 5/16" (994.517)	F3/8"G	F3/8"G
S. 430	8430.300	8420.300	without hose	F3/8"G	F1/2"G
	8430.301	8420.301	12m - 3/8" (995.512)	F3/8"G	F3/8"G
	8430.302	8420.302	18m - 3/8" (995.518)	F3/8"G	F3/8"G
	for ABS hose reels Series 430 see page 152				
S. 530	8530.300	8520.300	without hose	F3/8"G	F1/2"G
	8530.301	8520.301	20m - 3/8" (995.520)	F3/8"G	F3/8"G
	8530.302	8520.302	25m - 3/8" (995.525)	F3/8"G	F3/8"G
S. 540	8540.300	8550.300	without hose	F3/8"G	F1/2"G
	8540.301	8550.301	30m - 3/8" (995.530)	F3/8"G	F3/8"G
S. 560	8560.300	-	without hose	F3/8"G	F1/2"G
	8560.301	-	40m - 3/8" (995.540)	F3/8"G	F3/8"G
	8560.302	-	50m - 3/8" (995.550)	F3/8"G	F3/8"G

FIXED HOSE REELS INSTALLATION

The quick coupling support is equipped with 4 slot holes that allow an easy and safe installation of the hose reels. The **template** supplied facilitates drilling of the holes and there fore hose reels fixing.

SWIVELLING HOSE REELS INSTALLATION

The **quick coupling swivelling support** facilitates hose reels installation and enables **55° rotation** to the right or left or locking in **fixed positioned at 0°** by means of clamping with two screws.

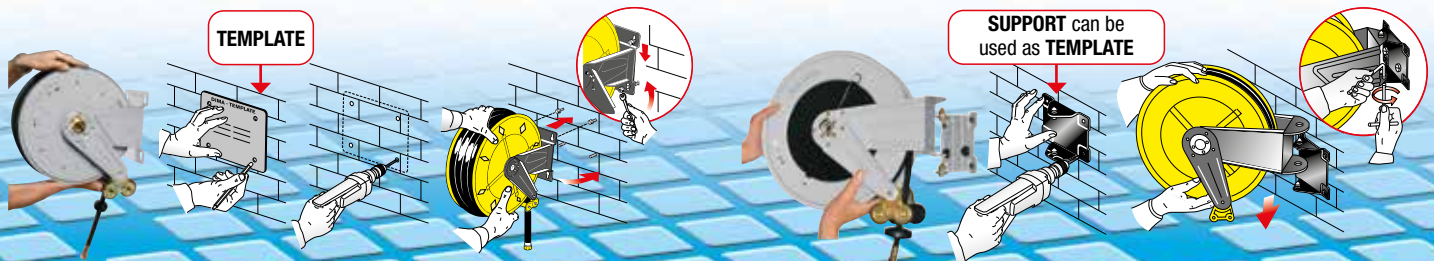



WATER MAX 130 °C - 200 bar

AISI 304 STAINLESS STEEL



ATEX directive
IIB 2 GD c T4 T135 °C X

Supplied with:

- hoses in black synthetic rubber
- zinc plated steel couplings
- AISI 304 stainless steel swivel joint
- "Viton®" seals



	FIXED		SWIVELLING		Hose supplied			Connection	
	Article	Article	Article	Article		inlet	outlet		
S. 330 hygienic hose	8332.300	-	-	-	without hose	F3/8" G	F 3/8" G		
	8332.301	-	-	-	12m - 5/16" (994.512)	F3/8" G	F3/8" G		
	8333.301	-	-	-	12m - 5/16" (994.612)	F3/8" G	F3/8" G		
S. 390 hygienic hose	8392.300	8382.300	8382.300	8382.300	without hose	F3/8" G	F 3/8" G		
	8392.302	8382.302	8382.302	8382.302	17m - 5/16" (994.517)	F3/8" G	F3/8" G		
	8393.301	8383.301	8383.301	8383.301	12m - 5/16" (994.612)	F3/8" G	F3/8" G		
S. 430 hygienic hose	8434.300	8424.300	8424.300	8424.300	without hose	F3/8" G	F1/2" G		
	8432.301	8422.301	8422.301	8422.301	12m - 3/8" (995.512)	F3/8" G	F3/8" G		
	8432.302	8422.302	8422.302	8422.302	18m - 3/8" (995.518)	F3/8" G	F3/8" G		
	8433.302	8423.302	8423.302	8423.302	18m - 3/8" (995.618)	F3/8" G	F3/8" G		
for ABS hose reels Series 430 see page 153									
S. 530 hygienic hose	8534.300	8524.300	8524.300	8524.300	without hose	F3/8" G	F1/2" G		
	8532.301	8522.301	8522.301	8522.301	20m - 3/8" (995.520)	F3/8" G	F3/8" G		
	8532.302	8522.302	8522.302	8522.302	25m - 3/8" (995.525)	F3/8" G	F3/8" G		
	8533.302	8523.302	8523.302	8523.302	25m - 3/8" (995.625)	F3/8" G	F3/8" G		
S. 540 hygienic hose	8544.300	8554.300	8554.300	8554.300	without hose	F3/8" G	F1/2" G		
	8542.301	8552.301	8552.301	8552.301	30m - 3/8" (995.530)	F3/8" G	F3/8" G		
	8543.301	8553.301	8553.301	8553.301	30m - 3/8" (995.630)	F3/8" G	F3/8" G		
S. 560	8564.300	-	-	-	without hose	F3/8" G	F1/2" G		
	8562.301	-	-	-	40m - 3/8" (995.540)	F3/8" G	F3/8" G		
	8562.302	-	-	-	50m - 3/8" (995.550)	F3/8" G	F3/8" G		



FIXED OVERALL DIMENSIONS

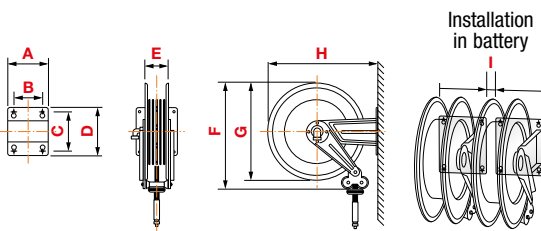

Art.	A	B	C	D	E	F	G	H	I	1-m ³	kg*
S. 330	186	140	196	226	110	355	350	365	20	0,045	from 8 to 13
S. 390	186	140	196	226	110	400	390	410	20	0,068	from 11 to 18
S. 430	186	140	196	226	115	460	420	460	20	0,098	from 14 to 24
S. 530	203	153	220	258	115	550	510	560	20	0,120	from 19 to 42
S. 540	300	218	228	268	190	550	510	573	0	0,175	from 24 to 40
S. 560	488	399	238	272	368	550	510	578	0	0,310	from 30 to 80

SWIVELLING OVERALL DIMENSIONS

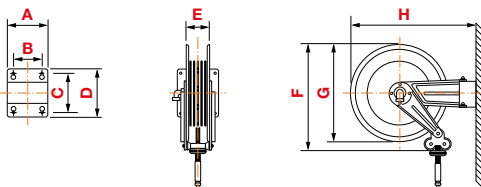

Art.	A	B	C	D	E	F	G	H	1-m ³	kg
S. 380	184	146	106	144	110	400	390	484	0,098	from 12 to 19
S. 420	208	162	118	164	115	460	420	541	0,098	from 15 to 25
S. 520	228	182	154	200	115	560	510	642	0,120	from 20 to 43
S. 550	300	218	226	268	190	560	510	702	0,175	from 25 to 41

* The list shows min and max weight for each series: min weight refers to version without hose, max weight refers to heaviest version which depends on hose length and diameter.



WATER MAX 130 °C - 400 bar

PAINTED STEEL



ATEX directive
IIB 2 GD c T4 T135 °C X

Supplied with:

- hoses in black synthetic rubber
- zinc plated steel couplings
- AISI 304 stainless steel swivel joint
- "Teflon®" seals



FIXED

Article

8330.350

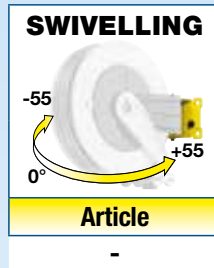

SWIVELLING

Article

-

Hose supplied	Connection	
	inlet	outlet
without hose	F3/8" G	F3/8" G



S. 330

S. 390

S. 430

S. 530

S. 540

S. 560

8390.350

8390.352

8430.350

8430.354

8530.350

8530.352

8540.350

8560.350

8380.350

8380.352

8420.350

8420.354

8520.350

8520.352

8550.350

-

-

without hose

17m - 5/16" (994.717)

without hose

15m - 3/8" (995.815)

without hose

25m - 3/8" (995.825)

without hose

without hose

F3/8" G

F3/8" G

F3/8" G

F3/8" G

F3/8" G

F3/8" G

F3/8" G

F3/8" G

F3/8" G

F3/8" G

F1/2" G

F3/8" G

F1/2" G

F3/8" G

F1/2" G

F1/2" G

FIXED HOSE REELS INSTALLATION

The quick coupling support is equipped with 4 slot holes that allow an easy and safe installation of the hose reels.

The **template** supplied facilitates drilling of the holes and there fore hose reels fixing.

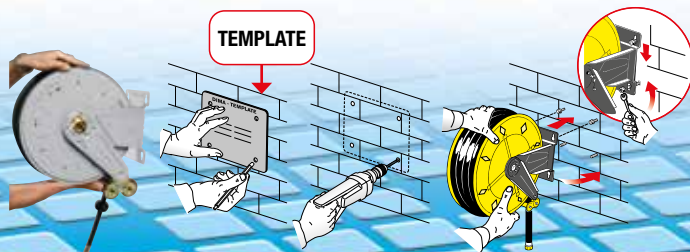

SWIVELLING HOSE REELS INSTALLATION

The **quick coupling swivelling support** facilitates hose reels installation and enables **55° rotation** to the right or left or locking in **fixed positioned at 0°** by means of clamping with two screws.

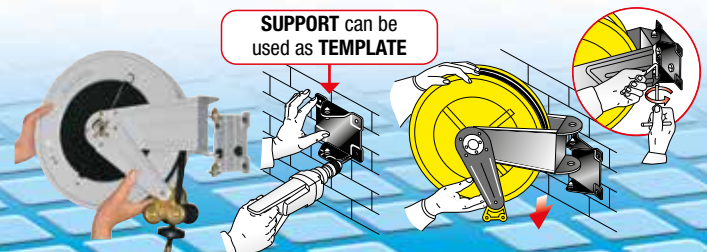



WATER MAX 130 °C - 400 bar

AISI 304 STAINLESS STEEL



ATEX directive
IIB 2 GD c T4 T135 °C X

FIXED



Article
8332.350

SWIVELLING

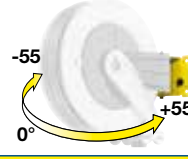

Article
-

Supplied with:

- hoses in black synthetic rubber
- zinc plated steel couplings
- AISI 304 stainless steel swivel joint
- "Teflon®" seals



Article	Hose supplied	Connection	
		inlet	outlet
S. 330	without hose	F3/8" G	F3/8" G
S. 390	without hose	F3/8" G	F3/8" G
	17m - 5/16" (994.717)	F3/8" G	F3/8" G
S. 430	without hose	F3/8" G	F1/2" G
	15m - 3/8" (995.815)	F3/8" G	F3/8" G
hygienic hose	15m - 3/8" (995.915)	F3/8" G	F3/8" G
S. 530	without hose	F3/8" G	F1/2" G
	25m - 3/8" (995.825)	F3/8" G	F3/8" G
hygienic hose	25m - 3/8" (995.925)	F3/8" G	F3/8" G
S. 540	without hose	F3/8" G	F1/2" G
S. 560	without hose	F3/8" G	F1/2" G

FIXED OVERALL DIMENSIONS

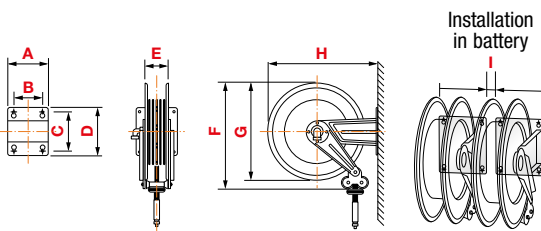

Art.	A	B	C	D	E	F	G	H	I	1-m ³	kg*
S. 330	186	140	196	226	110	355	350	365	20	0,045	from 8 to 13
S. 390	186	140	196	226	110	400	390	410	20	0,068	from 11 to 18
S. 430	186	140	196	226	115	460	420	460	20	0,098	from 14 to 24
S. 530	203	153	220	258	115	550	510	560	20	0,120	from 19 to 42
S. 540	300	218	228	268	190	550	510	573	0	0,175	from 24 to 40
S. 560	488	399	238	272	368	550	510	578	0	0,310	from 30 to 80

SWIVELLING OVERALL DIMENSIONS

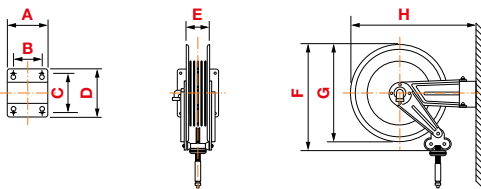

Art.	A	B	C	D	E	F	G	H	1-m ³	kg
S. 380	184	146	106	144	110	400	390	484	0,098	from 12 to 19
S. 420	208	162	118	164	115	460	420	541	0,098	from 15 to 25
S. 520	228	182	154	200	115	560	510	642	0,120	from 20 to 43
S. 550	300	218	226	268	190	560	510	702	0,175	from 25 to 41

* The list shows min and max weight for each series: min weight refers to version without hose, max weight refers to heaviest version which depends on hose length and diameter.



WATER MAX 130 °C - 100-200-400 bar

AISI 304 STAINLESS STEEL

Supplied with:

- AISI 304 stainless steel couplings
- AISI 304 stainless steel swivel joint
- "Viton®" seals (100-200 bar)
- "Teflon®" seals (400 bar)



ATEX directive
IIB 2 GD c T4 T135 °C X



FIXED

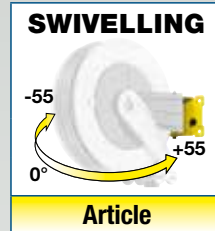

SWIVELLING



S. 430

	Article	Article	Connection	
			inlet	outlet
Water 130 °C 100 bar	8434.200	8424.200	F1/2"G	F1/2"G
Water 130 °C 200 bar	8434.300	8424.300	F3/8"G	F1/2"G
Water 130 °C 400 bar	8434.350	8424.350	F3/8"G	F1/2"G



S. 530

Water 130 °C 100 bar	8534.200	8524.200	F1/2"G	F1/2"G
Water 130 °C 200 bar	8534.300	8524.300	F3/8"G	F1/2"G
Water 130 °C 400 bar	8534.350	8524.350	F3/8"G	F1/2"G



S. 540

Water 130 °C 100 bar	8544.200	8554.200	F1"G	F1"G
	8544.205	8554.205	F1/2"G	F1/2"G
Water 130 °C 200 bar	8544.300	8554.300	F3/8"G	F1/2"G
Water 130 °C 400 bar	8544.350	8554.350	F3/8"G	F1/2"G



S. 560

Water 130 °C 100 bar	8564.200	-	F1"G	F1"G
	8564.206	-	F1/2"G	F1/2"G
Water 130 °C 200 bar	8564.300	-	F3/8"G	F1/2"G
Water 130 °C 400 bar	8564.350	-	F3/8"G	F1/2"G

FIXED HOSE REELS INSTALLATION

The quick coupling support is equipped with 4 slot holes that allow an easy and safe installation of the hose reels.
The **template** supplied facilitates drilling of the holes and therefore hose reels fixing.

SWIVELLING HOSE REELS INSTALLATION

The **quick coupling swivelling support** facilitates hose reels installation and enables **55° rotation** to the right or left or locking in **fixed positioned at 0°** by means of clamping with two screws.

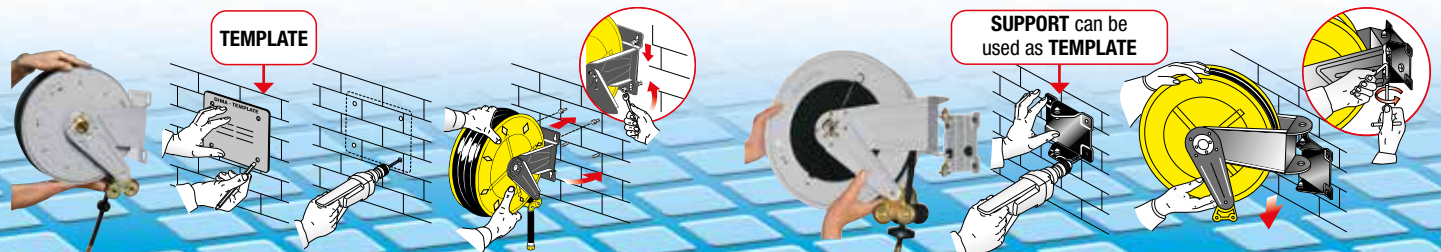



WATER MAX 130 °C - 100 bar

AISI 316 STAINLESS STEEL

Supplied with:

- AISI 316 stainless steel couplings
- AISI 316 stainless steel swivel joint
- "Viton®" seals

FIXED



Article

8545.200

Connection

inlet

outlet

F1" G

F1" G

Water 130 °C 100 bar



ATEX directive
IIB 2 GD c T4 T135 °C X



S. 540

EXAMPLE OF USE

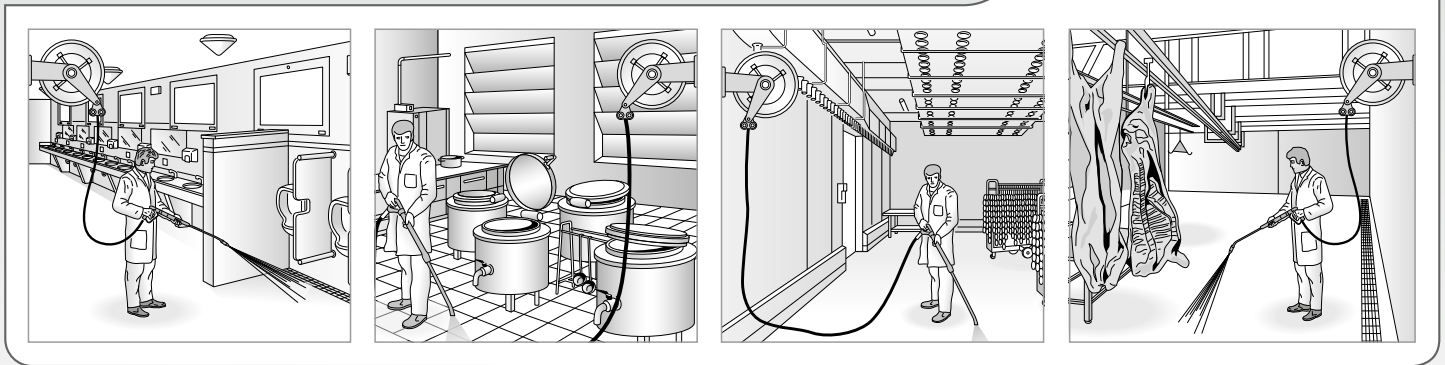

Hose reels capacity

To establish the **capacity of a hose reels** (max length of hose to be wound) it is necessary to know the following data:

- hose reels spring rewinding capacity
- external diameter of hose to be used

	ø 17 mm	max. 21 m	Series 430
	ø 19,5 mm	max. 16 m	
	ø 22 mm	max. 14 m	

	ø 18,5 mm	max. 28 m	Series 530
	ø 20 mm	max. 26 m	
	ø 22 mm	max. 24 m	

	ø 22 mm	max. 30 m	Series 540 outlet 1/2"
	ø 28 mm	max. 22 m	Series 540 outlet 1"
	ø 34 mm	max. 17 m	

	ø 22 mm	max. 60 m	Series 560 outlet 1/2"
	ø 30 mm	max. 40 m	Series 560 outlet 1"
	ø 35 mm	max. 30 m	

FIXED OVERALL DIMENSIONS

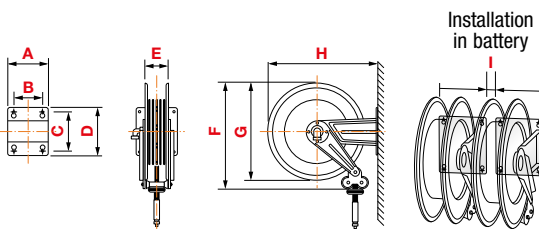

Art.	A	B	C	D	E	F	G	H	I	1-m ³	kg
S. 430	186	140	196	226	115	460	420	460	20	0,098	16
S. 530	203	153	220	258	115	550	510	560	20	0,120	21
S. 540	300	218	228	268	190	550	510	573	0	0,175	28,5
S. 560	488	399	238	272	368	550	510	578	0	0,310	48

SWIVELLING OVERALL DIMENSIONS

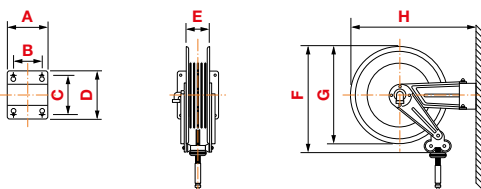

Art.	A	B	C	D	E	F	G	H	1-m ³	kg
S. 420	208	162	118	164	115	460	420	541	0,098	16,5
S. 520	228	182	154	200	115	560	510	642	0,120	21,5
S. 550	300	218	226	268	190	560	510	702	0,175	34



OIL AND SIMILAR PRODUCTS - 150 bar

PAINTED STEEL

Ex ATEX directive
IIB 2 GD c T4 T135 °C X

- Supplied with:
- hoses in black synthetic rubber
 - zinc plated steel couplings
 - carbon steel swivel joint
 - "polyurethane" seals



FIXED



SWIVELLING

	Article		Hose supplied	Connection	
	inlet	outlet		inlet	outlet
S. 330	8330.400	-	without hose	F1/2"G	F 3/8"-1/2"G
	8330.402	-	12m - 3/8" (995.312)	F1/2"G	M1/2"G
S. 390	8390.400	8380.400	without hose	F1/2"G	F 3/8"-1/2"G
	8390.401	8380.401	12m - 3/8" (995.312)	F1/2"G	M1/2"G
	8390.402	8380.402	17m - 3/8" (995.317)	F1/2"G	M1/2"G
S. 430	8430.400	8420.400	without hose	F1/2"G	F1/2"G
	8430.401	8420.401	10m - 1/2" (996.310)	F1/2"G	M1/2"G
	8430.402	8420.402	15m - 1/2" (996.315)	F1/2"G	M1/2"G
for ABS hose reels Series 430 see page 152					
S. 530	8530.400	8520.400	without hose	F1/2"G	F1/2"G
	8530.401	8520.401	20m - 1/2" (996.320)	F1/2"G	M1/2"G
	8530.402	8520.402	25m - 1/2" (996.325)	F1/2"G	M1/2"G
S. 540	8540.400	8550.400	without hose	F1"G	F1"G
	8540.411 **	8550.411 **	15m - 3/4" (997.3315)	F1"G	M3/4"G
	8540.412 **	8550.412 **	20m - 3/4" (997.3320)	F1"G	M3/4"G
	8540.413 *	8550.413 *	15m - 1" (998.3315)	F1"G	M1"G
	8540.405	8550.405	without hose	F1/2"G	F1/2"G
	8540.406	8550.406	30m - 1/2" (996.330)	F1/2"G	M1/2"G
S. 560	8560.400	-	without hose	F1"G	F1"G
	8560.415 *	-	30m - 1" (998.3330)	F1"G	M1"G

* 50 bar
** 100 bar

* 50 bar
** 100 bar



FIXED HOSE REELS INSTALLATION

The quick coupling support is equipped with 4 slot holes that allow an easy and safe installation of the hose reels.
The **template** supplied facilitates drilling of the holes and therefore hose reels fixing.

SWIVELLING HOSE REELS INSTALLATION

The **quick coupling swivelling support** facilitates hose reels installation and enables **55° rotation** to the right or left or locking in **fixed positioned at 0°** by means of clamping with two screws.

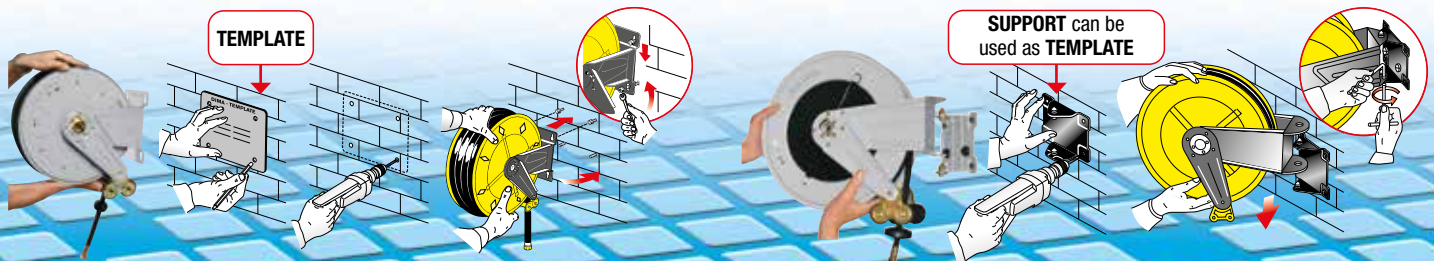



OIL AND SIMILAR PRODUCTS - 150 bar

AISI 304 STAINLESS STEEL



ATEX directive
IIB 2 GD c T4 T135 °C X

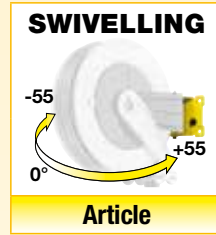

Supplied with:
- zinc plated steel couplings
- AISI 304 stainless steel swivel joint
- "Viton®" seals

Hose supplied	Connection	
	inlet	outlet



Article	Article	Hose supplied	Connection inlet	Connection outlet
S. 390	8392.200	8382.200	without hose	F1/2"G F 3/8"-1/2"G
S. 430	8434.200	8424.200	without hose	F1/2"G F1/2"G
for ABS hose reels Series 430 see page 153				
S. 530	8534.200	8524.200	without hose	F1/2"G F1/2"G
S. 540	8544.200	8554.200	without hose	F1"G F1"G

FIXED OVERALL DIMENSIONS

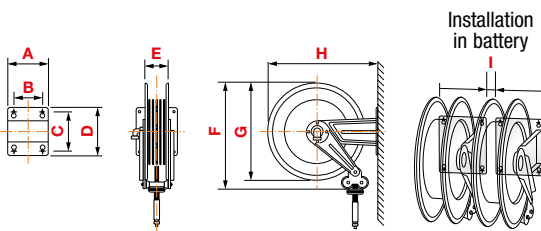

Art.	A	B	C	D	E	F	G	H	I	1-m ³	kg*
S. 330	186	140	196	226	110	355	350	365	20	0,045	from 8 to 13
S. 390	186	140	196	226	110	400	390	410	20	0,068	from 11 to 18
S. 430	186	140	196	226	115	460	420	460	20	0,098	from 14 to 24
S. 530	203	153	220	258	115	550	510	560	20	0,120	from 19 to 42
S. 540	300	218	228	268	190	550	510	573	0	0,175	from 24 to 40
S. 560	488	399	238	272	368	550	510	578	0	0,310	from 30 to 80

SWIVELLING OVERALL DIMENSIONS

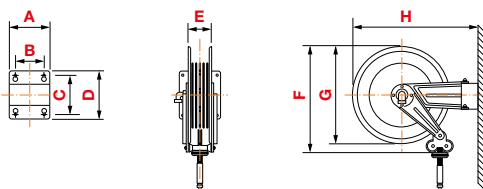

Art.	A	B	C	D	E	F	G	H	1-m ³	kg
S. 380	184	146	106	144	110	400	390	484	0,098	from 12 to 19
S. 420	208	162	118	164	115	460	420	541	0,098	from 15 to 25
S. 520	228	182	154	200	115	560	510	642	0,120	from 20 to 43
S. 550	300	218	226	268	190	560	510	702	0,175	from 25 to 41

* The list shows min and max weight for each series: min weight refers to version without hose, max weight refers to heaviest version which depends on hose length and diameter.



GREASE - 400 bar

PAINTED STEEL



ATEX directive
IIB 2 GD c T4 T135 °C X

Supplied with:

- hoses in black synthetic rubber
- zinc plated steel couplings
- carbon steel swivel joint
- "polyurethane" seals



FIXED

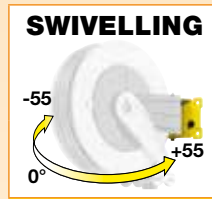

SWIVELLING

Article
8330.500 *
8330.501

S. 330

Article
-
-

Hose supplied	Connection	
	inlet	outlet
without hose	F3/8"G	F3/8"G
12m - 1/4" (993.511)	F3/8"G	M1/4"G



8390.500 *
8390.501
8390.502

S. 390

8380.500 *
8380.501
8380.502

without hose	F3/8"G	F3/8"G
12m - 1/4" (993.511)	F3/8"G	M1/4"G
16m - 1/4" (993.516)	F3/8"G	M1/4"G

8430.500 *
8430.501
8430.502
8430.505
8430.506

S. 430

8420.500 *
8420.501
8420.502
8420.505
8420.506

without hose	F3/8"G	F1/2"G
12m - 1/4" (993.512)	F3/8"G	M1/4"G
18m - 1/4" (993.518)	F3/8"G	M1/4"G
10m - 3/8" (995.710)	F3/8"G	M1/4"G
15m - 3/8" (995.715)	F3/8"G	M1/4"G

for ABS hose reels Series 430 see page 152

8530.500 *
8530.501
8530.502

S. 530

8520.500 *
8520.501
8520.502

without hose	F3/8"G	F1/2"G
20m - 3/8" (995.720)	F3/8"G	M1/4"G
25m - 3/8" (995.725)	F3/8"G	M1/4"G

8540.500 *
8540.501

S. 540

8550.500 *
8550.501

without hose	F3/8"G	F1/2"G
30m - 3/8" (995.730)	F3/8"G	M1/4"G

* 600 bar

* 600 bar

FIXED HOSE REELS INSTALLATION

The quick coupling support is equipped with 4 slot holes that allow an easy and safe installation of the hose reels.

The **template** supplied facilitates drilling of the holes and therefore hose reels fixing.

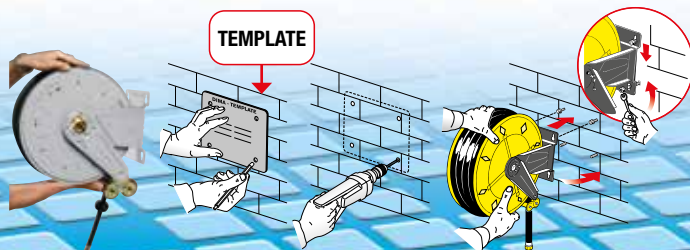

SWIVELLING HOSE REELS INSTALLATION

The **quick coupling swivelling support** facilitates hose reels installation and enables **55° rotation** to the right or left or locking in **fixed positioned at 0°** by means of clamping with two screws.

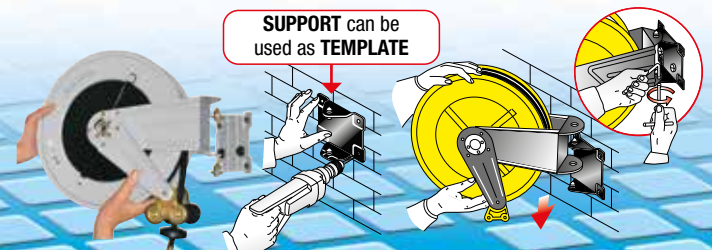



GREASE - 600 bar

AISI 304 STAINLESS STEEL

Supplied with:
 - zinc plated steel couplings
 - carbon steel swivel joint
 - "polyurethane" seals

 ATEX directive
 IIB 2 GD c T4 T135 °C X

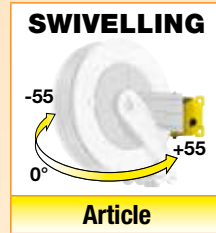

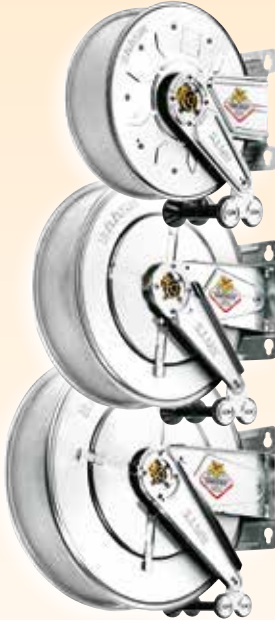

Hose supplied	Connection	
	inlet	outlet



Article	Article	Hose supplied	Connection inlet	Connection outlet
S. 390	8392.500	8382.500	without hose	F3/8"G F 3/8"G
S. 430	8432.500	8422.500	without hose	F3/8"G F1/2"G
for ABS hose reels Series 430 see page 153				
S. 530	8532.500	8522.500	without hose	F3/8"G F1/2"G

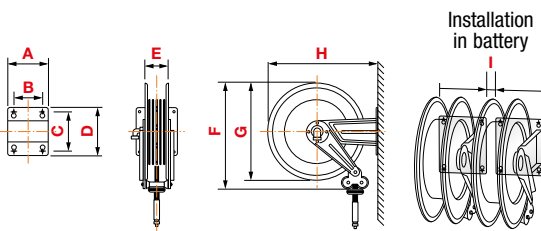

FIXED OVERALL DIMENSIONS

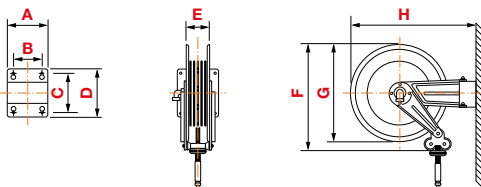

Art.	A	B	C	D	E	F	G	H	I	 1-m ³	 kg *
S. 330	186	140	196	226	110	355	350	365	20	0,045	from 8 to 13
S. 390	186	140	196	226	110	400	390	410	20	0,068	from 11 to 18
S. 430	186	140	196	226	115	460	420	460	20	0,098	from 14 to 24
S. 530	203	153	220	258	115	550	510	560	20	0,120	from 19 to 42
S. 540	300	218	228	268	190	550	510	573	0	0,175	from 24 to 40

SWIVELLING OVERALL DIMENSIONS



Art.	A	B	C	D	E	F	G	H	 1-m ³	 kg
S. 380	184	146	106	144	110	400	390	484	0,098	from 12 to 19
S. 420	208	162	118	164	115	460	420	541	0,098	from 15 to 25
S. 520	228	182	154	200	115	560	510	642	0,120	from 20 to 43

* The list shows min and max weight for each series: min weight refers to version without hose, max weight refers to heaviest version which depends on hose length and diameter.



DIESEL FUEL - 10 bar

PAINTED STEEL



ATEX directive
IIB 2 GD c T4 T135 °C X

FIXED



Supplied with:

- hoses in antistatic black synthetic rubber
- zinc plated steel couplings
- brass swivel joint
- "Viton®" seals



S. 530

Article
8530.600
8530.603
8530.604

Hose supplied	Connection	
	inlet	outlet
without hose	F1"G	F1"G
12m - 3/4" (997.812)	F1"G	M3/4"G
8m - 1" (998.808)	F1"G	M1"G

S. 540

8540.100
8540.601
8540.602
8540.603

without hose	F1"G	F1"G
15m - 3/4" (997.815)	F1"G	M3/4"G
20m - 3/4" (997.820)	F1"G	M3/4"G
15m - 1" (998.815)	F1"G	M1"G

S. 560

8560.100
8560.603
8560.604
8560.605

without hose	F1"G	F1"G
40m - 3/4" (997.840)	F1"G	M3/4"G
20m - 1" (998.820)	F1"G	M1"G
30m - 1" (998.830)	F1"G	M1"G

FIXED OVERALL DIMENSIONS

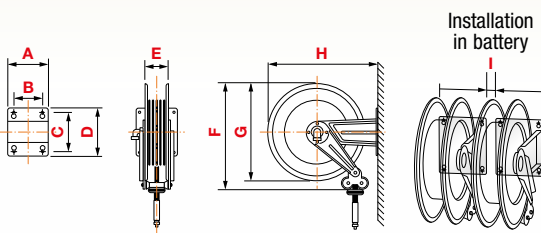

Art.	A	B	C	D	E	F	G	H	I	1-m ³	kg *
S. 530	203	153	220	258	115	550	510	560	20	0,120	from 19 to 42
S. 540	300	218	228	268	190	550	510	573	0	0,175	from 24 to 40
S. 560	488	399	238	272	368	550	510	578	0	0,310	from 30 to 80

* The list shows min and max weight for each series: min weight refers to version without hose, max weight refers to heaviest version which depends on hose length and diameter.

FIXED HOSE REELS INSTALLATION

The quick coupling support is equipped with 4 slot holes that allow an easy and safe installation of the hose reels. The **template** supplied facilitates drilling of the holes and there fore hose reels fixing.

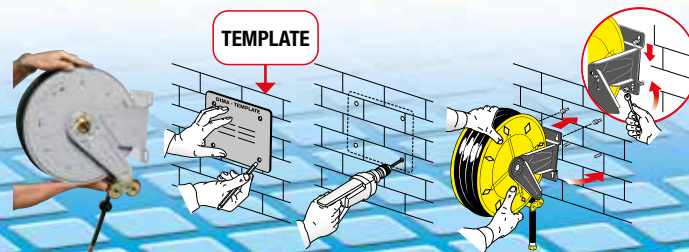



DIESEL FUEL - 10 bar

AISI 304 STAINLESS STEEL



ATEX directive
IIB 2 GD c T4 T135 °C X

FIXED



Article

Supplied with:

- hoses in antistatic black synthetic rubber
- zinc plated steel couplings
- brass swivel joint
- "Viton®" seals



Hose supplied	Connection	
	inlet	outlet



S. 540

8542.100	without hose	F1"G	F1"G
8542.601	15m - 3/4" (997.815)	F1"G	M3/4"G
8542.602	20m - 3/4" (997.820)	F1"G	M3/4"G
8542.603	15m - 1" (998.815)	F1"G	M1"G

S. 560

8562.100	without hose	F1"G	F1"G
8562.603	40m - 3/4" (997.840)	F1"G	M3/4"G
8562.604	20m - 1" (998.820)	F1"G	M1"G
8562.605	30m - 1" (998.830)	F1"G	M1"G

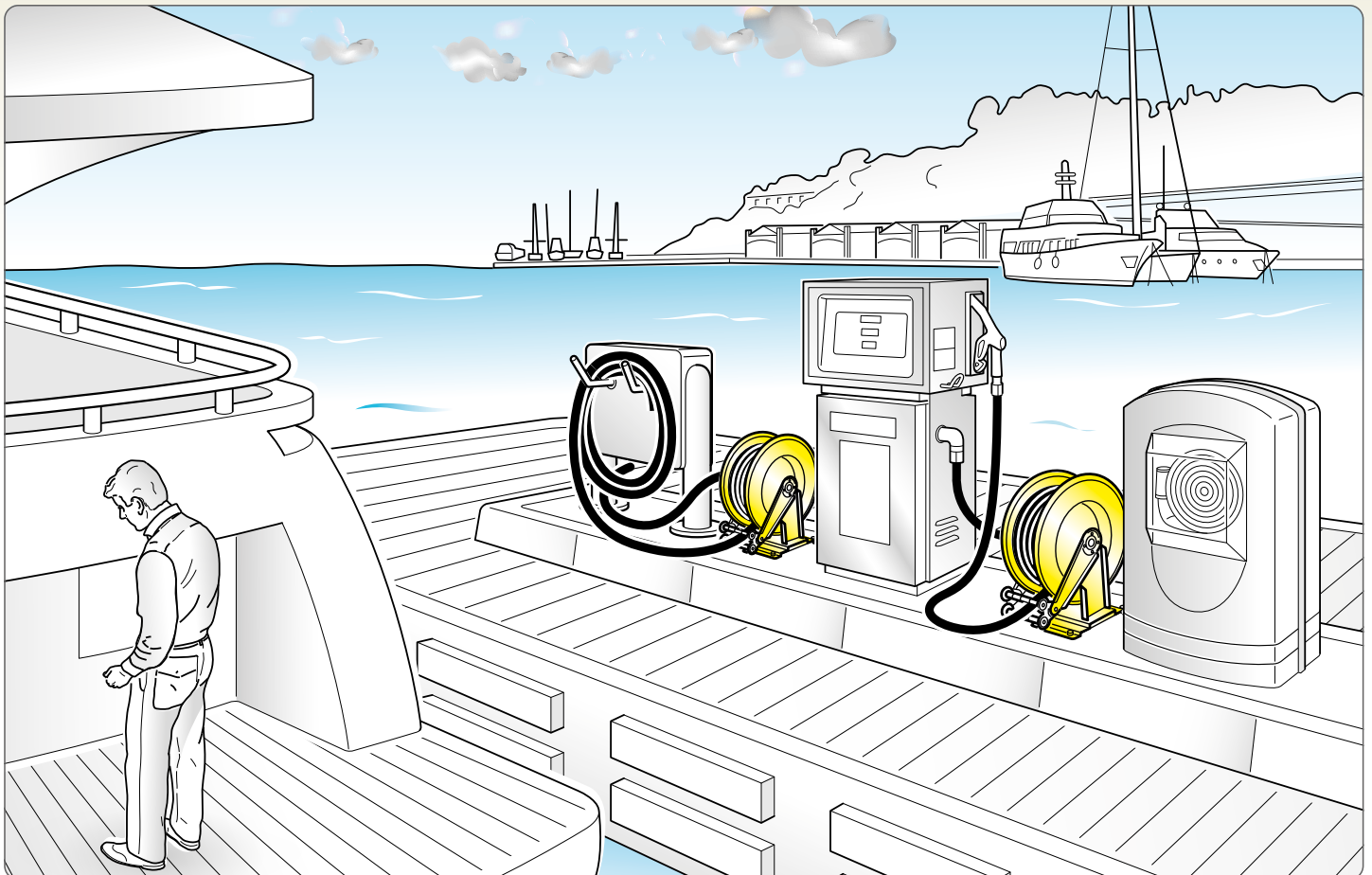



ADBLUE® - 10 bar

PAINTED STEEL



ATEX directive
IIB 2 GD c T4 T135 °C X
o II 3 GD c X (20 bar)



S. 436

FIXED



Article

8436.200

8434.250

8436.251

8436.252

Supplied with:

- hoses in antistatic EPDM rubber
- AISI 316L stainless steel couplings
- AISI 316L stainless steel swivel joint
- "Viton®" seals



Hose supplied	Connection	
	inlet	outlet
without hose	F1" G	F3/4" G
without hose	F1" G	F3/4" G
10m - 19x27 (987.210)	M1" G	M3/4" G
15m - 19x27 (987.215)	M1" G	M3/4" G

ADBLUE® - 10 bar

STAINLESS STEEL



S. 537

FIXED



Article

8537.200

8534.250

8537.251

8537.252

Supplied with:

- hoses in antistatic EPDM rubber
- AISI 316L stainless steel couplings
- AISI 316L stainless steel swivel joint
- "Viton®" seals



Hose supplied	Connection	
	inlet	outlet
without hose	F1" G	F1" G
without hose	F1" G	F1" G
10m - 19x27 (987.210)	M1" G	M3/4" G
15m - 19x27 (987.215)	M1" G	M3/4" G

Hose reels for AdBlue®, the fluid used in SCR systems which are present in Euro4 and Euro5 trucks, have been purposely designed by using **stainless steel AISI 316L** for those parts which get in contact with the fluid, avoiding in this way any contamination of the same fluid.

FIXED OVERALL DIMENSIONS

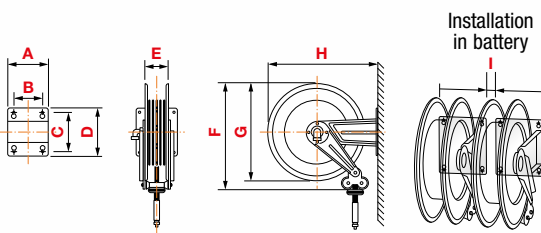

Art.	A	B	C	D	E	F	G	H	I	1-m ³	kg
S. 436	337	302	160	203	168	450	420	460	20	0,122	from 19 to 42
S. 537	203	153	220	258	115	550	510	560	0	0,120	from 19 to 42

* The list shows min and max weight for each series: min weight refers to version without hose, max weight refers to heaviest version which depends on hose length and diameter.

FIXED HOSE REELS INSTALLATION

The quick coupling support is equipped with 4 slot holes that allow an easy and safe installation of the hose reels. The **template** supplied facilitates drilling of the holes and there fore hose reels fixing.

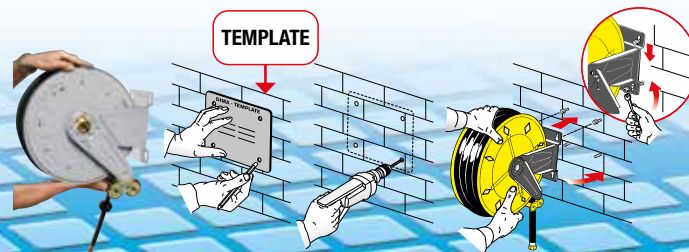



SERIES WITH DOUBLE INLET AND OUTLET

PAINTED STEEL



ATEX directive
IIB 2 GD c T4 T135 °C X

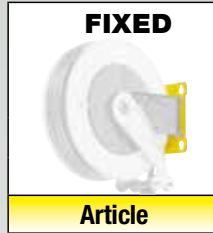

S. 430



Air - Water **20** bar

8430.1000

F1/2"G

M3/8"G

brass

Viton®

Oil - Water **200** bar

8430.3000

F3/8"G

M3/8"G

AISI 304
stainless steel

Viton®

Oil - Paint **150** bar

8430.4000

F1/2"G

M3/8"G

steel

polyurethane

Oil **400** bar

8430.5000

F3/8"G

M3/8"G

steel

polyurethane

S. 530



Air - Water **20** bar

8530.1000

F1/2"G

M3/8"G

brass

Viton®

Oil - Water **200** bar

8530.3000

F3/8"G

M3/8"G

AISI 304
stainless steel

Viton®

Oil - Paint **150** bar

8530.4000

F1/2"G

M3/8"G

steel

polyurethane

Oil **400** bar

8530.5000

F3/8"G

M3/8"G

steel

polyurethane

S. 540



Oil **400** bar

8540.5000

F3/8"G

M3/8"G

steel

polyurethane

Hose reels for dual hoses can be used for the applications where it is requested **the distribution of two fluids simultaneously** (e.g. air and paint in painting systems) or the recycle of the same fluid (e.g. for hydraulic tools).

FIXED OVERALL DIMENSIONS

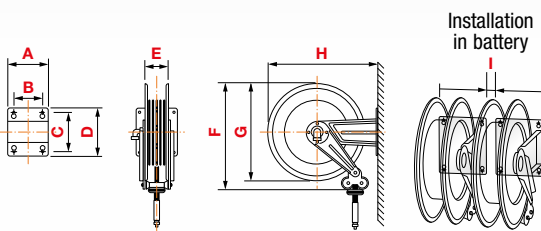

Art.	A	B	C	D	E	F	G	H	I	1-m ³	kg
S. 430	186	140	196	226	115	460	420	460	20	0,098	17,5
S. 530	203	153	220	258	115	550	510	560	20	0,120	24,5
S. 540	300	218	228	268	190	550	510	573	0	0,175	30

FIXED HOSE REELS INSTALLATION

The quick coupling support is equipped with 4 slot holes that allow an easy and safe installation of the hose reels.
The **template** supplied facilitates drilling of the holes and there fore hose reels fixing.

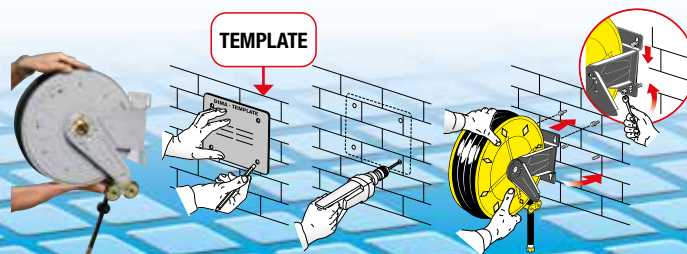



WELDING - 20 bar

PAINTED STEEL



ATEX directive
II 3 GD c (T5) 100 °C X

FIXED



Supplied with:

- double hose Standard ISO 3821, hoses SBR/EPDM rubber
- brass fitting
- brass swivel joint
- "Viton®" seals

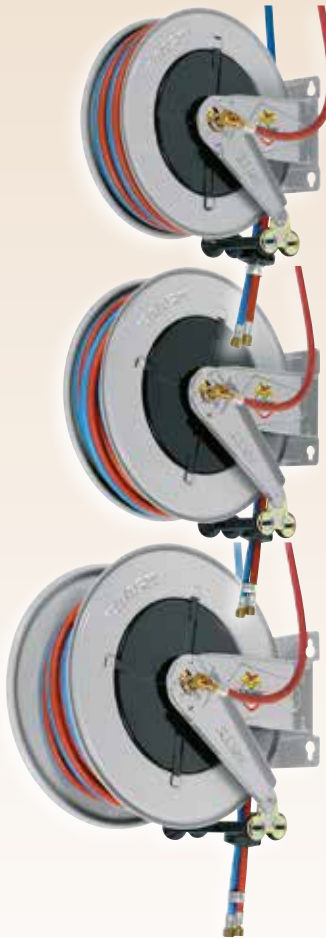

S. 430

Article
8430.700
8430.701
8430.702

Hose supplied	Connection	
	inlet	outlet
without hose	M3/8"G	M3/8"G
13m - 2x1/4" - 2x6 (973.913)	F3/8"G	F3/8"G
12m - 2x5/16" - 2x8 (974.912)	F3/8"G	F3/8"G

S. 530

8530.700
8530.701
8530.702
8530.703
8530.704
8530.705

without hose	M3/8"G	M3/8"G
17m - 2x1/4" - 2x6 (973.917)	F3/8"G	F3/8"G
20m - 2x1/4" - 2x6 (973.920)	F3/8"G	F3/8"G
15m - 2x5/16" - 2x8 (974.915)	F3/8"G	F3/8"G
20m - 2x5/16" - 2x8 (974.920)	F3/8"G	F3/8"G
15m - 2x3/8" - 2x9 (975.915)	F3/8"G	F3/8"G

S. 540

8540.700
8540.701
8540.702
8540.704
8540.705
8540.707
8540.709

without hose	M3/8"G	M3/8"G
25m - 2x1/4" - 2x6 (973.925)	F3/8"G	F3/8"G
30m - 2x1/4" - 2x6 (973.930)	F3/8"G	F3/8"G
25m - 2x5/16" - 2x8 (974.925)	F3/8"G	F3/8"G
30m - 2x5/16" - 2x8 (974.930)	F3/8"G	F3/8"G
20m - 2x3/8" - 2x9 (975.920)	F3/8"G	F3/8"G
27m - 2x3/8" - 2x9 (975.927)	F3/8"G	F3/8"G

FIXED OVERALL DIMENSIONS

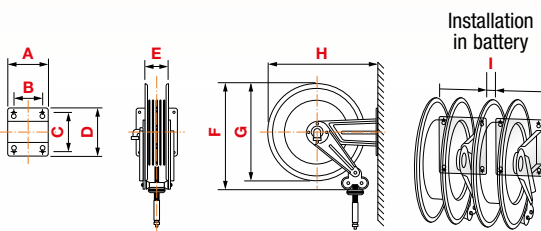

Art.	A	B	C	D	E	F	G	H	I	1-m ³	kg *
S. 430	186	140	196	226	115	460	420	460	20	0,098	from 14 to 24
S. 530	203	153	220	258	115	550	510	560	20	0,120	from 19 to 42
S. 540	300	218	228	268	190	550	510	573	0	0,175	from 24 to 40

* The list shows min and max weight for each series: min weight refers to version without hose, max weight refers to heaviest version which depends on hose length and diameter.

FIXED HOSE REELS INSTALLATION

The quick coupling support is equipped with 4 slot holes that allow an easy and safe installation of the hose reels. The **template** supplied facilitates drilling of the holes and there fore hose reels fixing.

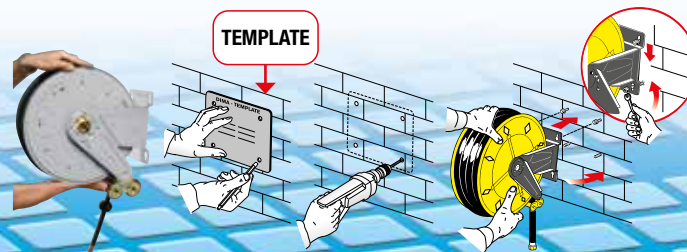



LPG-METHANE - 20 bar

PAINTED STEEL

FIXED



- Supplied with:
- orange hose Standard ISO 3821
 - brass fitting
 - brass swivel joint
 - "Viton®" seals



Ex ATEX directive
II 3 GD c (T5) 100 °C X



Article	Hose supplied	Connection		
		inlet	outlet	
S. 330	8330.800	without hose	M3/8"G Sx	M3/8"G Sx
	8330.801	8m - 8x15 (974.1008)	F3/8"G Sx	F3/8"G Sx
	8330.802	10m - 10x17 (975.1010)	F3/8"G Sx	F3/8"G Sx
S. 390	8390.800	without hose	M3/8"G Sx	M3/8"G Sx
	8390.801	15m - 8x15 (974.1015)	F3/8"G Sx	F3/8"G Sx
	8390.802	15m - 10x17 (975.1015)	F3/8"G Sx	F3/8"G Sx
S. 430	8430.800	without hose	M3/8"G Sx	M3/8"G Sx
	8430.802	20m - 8x15 (974.1020)	F3/8"G Sx	F3/8"G Sx
	8430.804	18m - 10x17 (975.1018)	F3/8"G Sx	F3/8"G Sx
S. 530	8530.800	without hose	M3/8"G Sx	M3/8"G Sx
	8530.802	28m - 8x15 (974.1028)	F3/8"G Sx	F3/8"G Sx
	8530.804	27m - 10x17 (975.1027)	F3/8"G Sx	F3/8"G Sx
S. 540	8540.800	without hose	M3/8"G Sx	M3/8"G Sx
	8540.802	30m - 10x17 (975.1030)	F3/8"G Sx	F3/8"G Sx

FIXED OVERALL DIMENSIONS

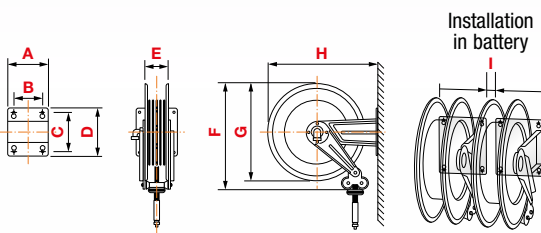

Art.	A	B	C	D	E	F	G	H	I	1-m ³	kg *
S. 330	186	140	196	226	110	355	350	365	20	0,045	from 8 to 13
S. 390	186	140	196	226	110	400	390	410	20	0,068	from 11 to 18
S. 430	186	140	196	226	115	460	420	460	20	0,098	from 14 to 24
S. 530	203	153	220	258	115	550	510	560	20	0,120	from 19 to 42
S. 540	300	218	228	268	190	550	510	573	0	0,175	from 24 to 40

* The list shows min and max weight for each series: min weight refers to version without hose, max weight refers to heaviest version which depends on hose length and diameter.

FIXED HOSE REELS INSTALLATION

The quick coupling support is equipped with 4 slot holes that allow an easy and safe installation of the hose reels. The **template** supplied facilitates drilling of the holes and there fore hose reels fixing.

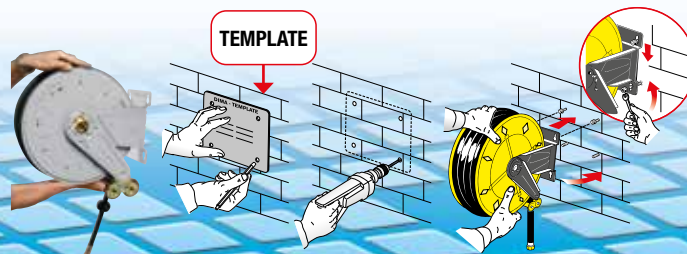



HYDRAULIC MOTOR-OPERATED SERIES

S. 617 HYDRAULIC

S. 637 HYDRAULIC

The adjustable arms can be easily repositioned according to needs.

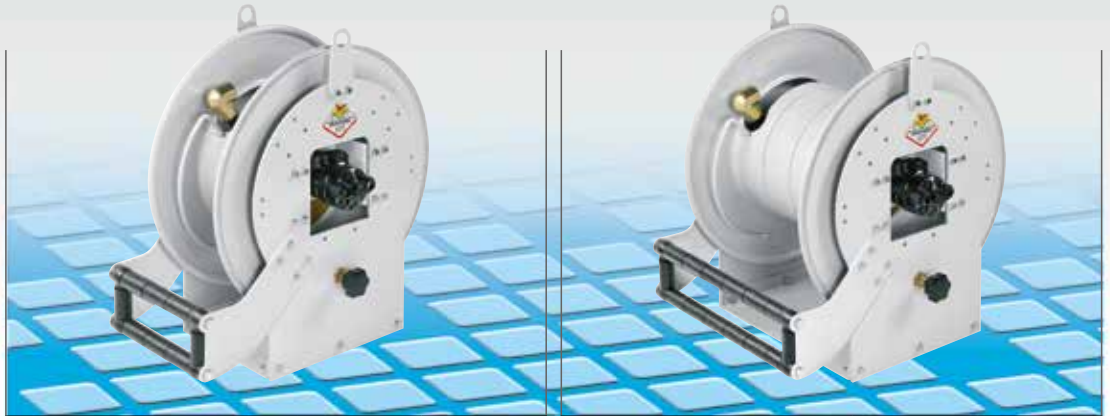
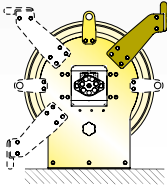

HYDRAULIC Article	Connection		HYDRAULIC Article	Connection	
	inlet	outlet		inlet	outlet

Air - Water 20 bar - brass swivel joint - "Viton®" seals	8617.100	F1"G	F1"G	8637.100	F1"G	F1"G
Water max 130 °C 100 bar - AISI 304 stainless steel swivel joint - "Viton®" seals	8617.200	F1"G	F1"G	8637.200	F1"G	F1"G
Oil and similar products 150 bar - carbon steel swivel joint - "polyurethane" seals	8617.400	F1"G	F1"G	8637.400	F1"G	F1"G
Grease 400 bar - carbon steel swivel joint - "polyurethane" seals	8617.500	F1"G	F1"G	8637.500	F1"G	F1"G
Diesel fuel 10 bar - carbon steel swivel joint - "Viton®" seals	8617.600	F1.1/2"G	F1.1/2"G	8637.600	F1.1/2"G	F1.1/2"G

WALL MOUNTING

After choosing the ideal position, checking the consistency and thickness of the wall, marking the holes for the plugs (see template supplied with the hose reels) and making sure they do not interfere with hydraulic pipes or electrical wires, proceed with drilling. Fix the plugs in the wall and insert the hose reels in the special seats. Tighten the 4 fixing nuts.

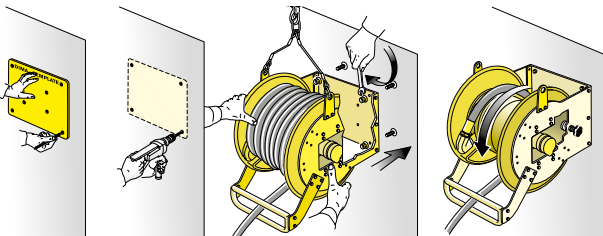

HOSE MOUNTING - 1" - 1.1/2" Connector

Before carrying out the operation, make sure the hose reels drum is locked by means of the parking brake **F**. Screw one Nipple **N** on the outlet elbow **G**. Apply the hose on Nipple **N**.

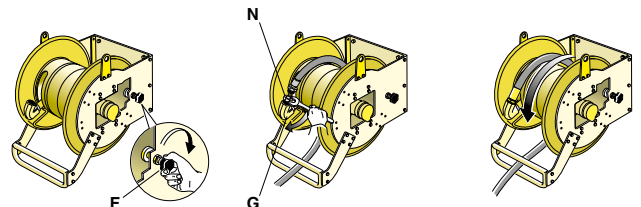

HYDRAULIC OVERALL DIMENSIONS

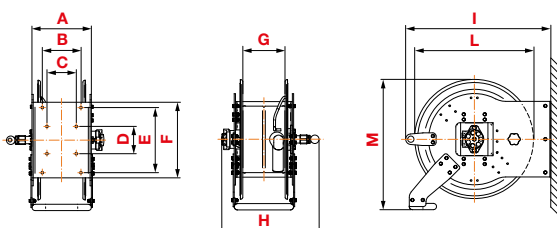

Art.	A	B	C	D	E	F	G	H	I	L	M	1-m ³	kg
S. 617	283	185	140	130	310	360	220	463	692	570	621	0,310	from 55 to 86
S. 637	467	370	140	130	310	360	400	649	692	570	621	0,473	from 75 to 137



AIR MOTOR-OPERATED SERIES

S. 618 PNEUMATIC

S. 638 PNEUMATIC

The adjustable arms can be easily repositioned according to needs.

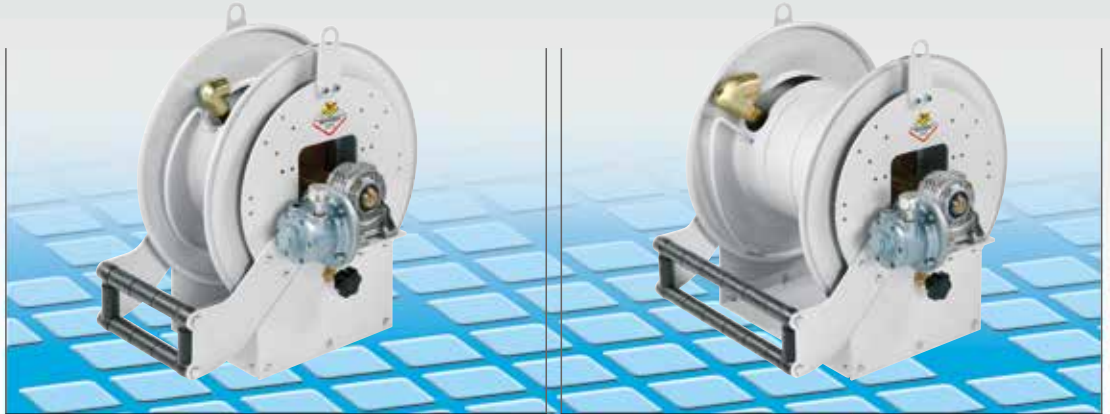
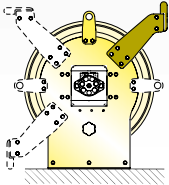

PNEUMATIC Article	Connection		PNEUMATIC Article	Connection	
	inlet	outlet		inlet	outlet

Air - Water 20 bar - bras swivel joint - "Viton®" seals	8618.100	F1"G	F1"G	8638.100	F1"G	F1"G
Water max 130 °C 100 bar - AISI 304 stainless steel swivel joint - "Viton®" seals	8618.200	F1"G	F1"G	8638.200	F1"G	F1"G
Oil and similar products 150 bar - carbon steel swivel joint - "polyurethane" seals	8618.400	F1"G	F1"G	8638.400	F1"G	F1"G
Grease 400 bar - carbon steel swivel joint - "polyurethane" seals	8618.500	F1"G	F1"G	8638.500	F1"G	F1"G
Diesel fuel 10 bar - brass swivel joint - "Viton®" seals	8618.100	F1"G	F1"G	8638.100	F1"G	F1"G

HOSE MOUNTING - 1" Connector

Before carrying out the operation, make sure the hose reels drum is locked by means of the brake **F**. Remove the outlet elbow **G**. Screw one Nipple **N** on the outlet elbow **G**. Screw the hose on nipple **N**. Refit the outlet elbow **G** with the assembled parts.

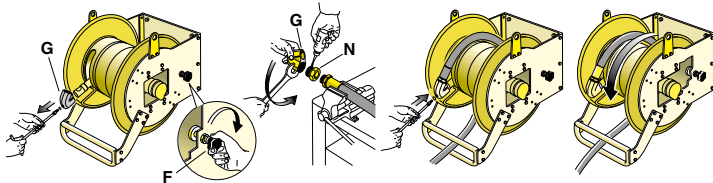

POWER SUPPLY

The hydraulic motor-operated hose reels are fed, by means of a control, by an electric control unit (control and control unit not supplied).

The air motor-operated hose reels are fed, by means of a control, with direct connection to the compressed air system (control not supplied).

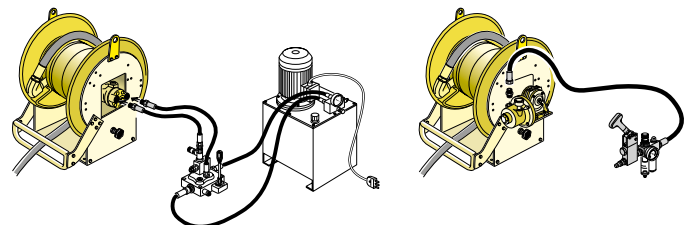

PNEUMATIC OVERALL DIMENSIONS

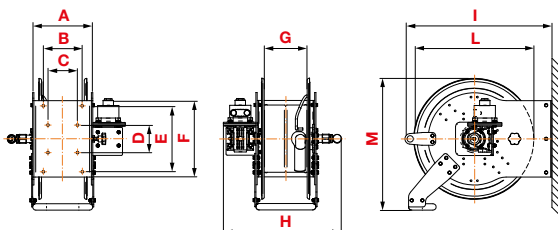

HYDRAULIC MOTOR-OPERATED
Oil pressure max 170 bar at
5 l/min inlet feeding

AIR MOTOR-OPERATED HOSE REELS
Air pressure max 7 bar at
2000 l/min inlet feeding

Art.	A	B	C	D	E	F	G	H	I	L	M	1-m ³	kg
S. 618	283	185	140	130	310	360	220	555	692	570	621	0,310	from 51 to 82
S. 638	467	370	140	130	310	360	400	740	692	570	621	0,473	from 71 to 133



SERIES 500 MANUAL

PAINTED STEEL

Manual rewinding hose reels are an easy and practical way to manage flexible hoses. Operation is extremely simple and needs very little maintenance. Made with high quality materials with a robust frame, manual rewinding hose reels are an inexpensive alternative to spring rewinding hose reels particularly for very long hoses.



	width 240 mm	width 320 mm	width 460 mm	width 600 mm	Connection	
					inlet	outlet
Air - Water 20 bar - brass swivel joint - "Viton®" seals	7522001.100	7532001.100	7552001.100	7562001.100	F 1"	F 1"
	7522001.150	7532001.150	7552001.150	7562001.150	F 1/2"	F 1/2"
Water max 130 °C 100 bar - AISI 304 stainless steel swivel joint - "Viton®" seals	7522001.200	7532001.200	7552001.200	7562001.200	F 1"	F 1"
	7522001.250	7532001.250	7552001.250	7562001.250	F 1/2"	F 1/2"
Water max 130 °C 200 bar - AISI 304 stainless steel swivel joint - "Viton®" seals	7522001.300	7532001.300	7552001.300	7562001.300	F 3/8"	F 1/2"
Oil and similar products 150 bar - carbon steel swivel joint - "polyurethane" seals	7522001.400	7532001.400	7552001.400	7562001.400	F 1"	F 1"
	7522001.450	7532001.450	7552001.450	7562001.450	F 1/2"	F 1/2"
Diesel fuel 10 bar - brass swivel joint - "Viton®" seals	7522001.100	7532001.100	7552001.100	7562001.100	F 1"	F 1"

Hose reels capacity	L240	L320	L460	L600
ø 3/8"	50 m	80 m	120 m	160 m
ø 1/2"	40 m	70 m	105 m	140 m
ø 3/4"	25 m	40 m	60 m	80 m
ø 1"	20 m	30 m	45 m	60 m

OVERALL DIMENSIONS

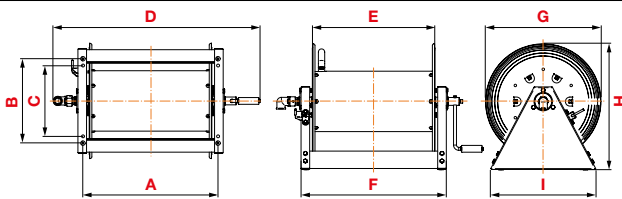

Art.	A	B	C	D	E	F	G	H	I	1-m ³	kg
L 240	297	373	313	631	242	342	510	555	468	0,208	25,2
L 320	377	373	313	711	322	422	510	555	468	0,243	26,8
L 460	517	373	313	851	462	562	510	555	468	0,304	29,3
L 600	657	373	313	991	602	702	510	555	468	0,365	31,9

Technical features

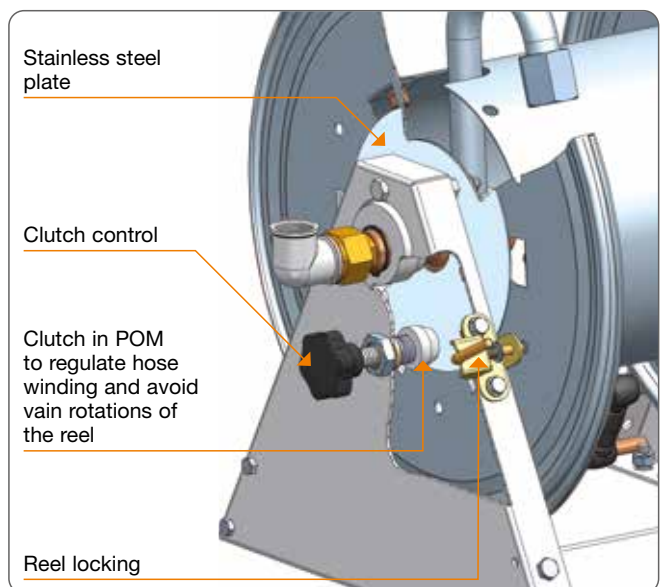



GROUNDING REEL

Grounding reel satisfies the need to ground fuel tanks during transferring operation in order to discharge electric charges.



APPLICATIONS:

tanks and oil-refinery, aviation, tank truck, boating.



Operation:

Before begin fuel transfer operator must connect the grounding clamp, mounted at the end of the cable, to the grounding plate which is compulsory on every tank truck (Pic. A). As an alternative the grounding reel may be installed on the tank truck and the clamp connected to the grounding plate (Pic. B). Grounding reel must be installed in a safe zone (potentially not dangerous) since it is not provided with ATEX Certification.

Antiexplosive clamp, standard on some models below listed, may be installed in a potential explosive area (Zone 1) as specified in the CE declaration.

Pic. A

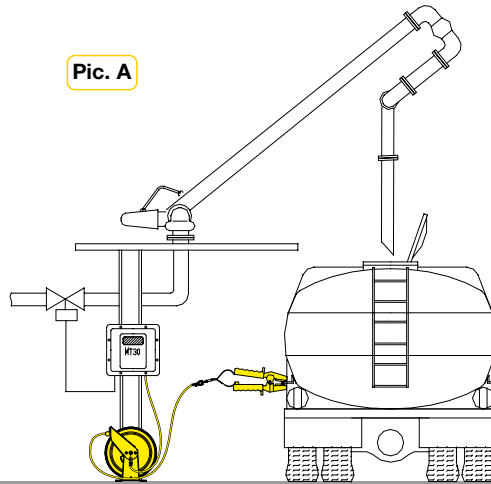

Pic. B

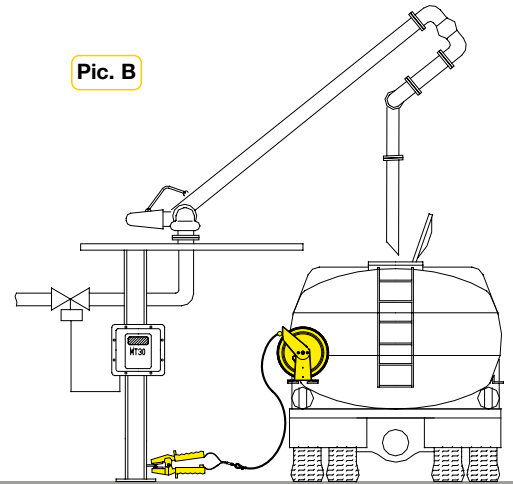

Article	Cable material	Insulation	Cable cross section	Cable length	Grounding clamp
735000	without cable	max cable capacity 30 m - cross section 16 mm ²			
735131.60141	copper	PUR	6 mm ²	14,5 m	antiexplosive 10A
735131.60261	copper	PUR	6 mm ²	26 m	antiexplosive 10A
735131.60152	copper	PUR	6 mm ²	15 m	standard 50A
735131.60252	copper	PUR	6 mm ²	25 m	standard 50A
735141.60152	steel	PVC	7x7 ø 5 mm	15 m	standard 50A
735141.60252	steel	PVC	7x7 ø 5 mm	25 m	standard 50A

OVERALL DIMENSIONS

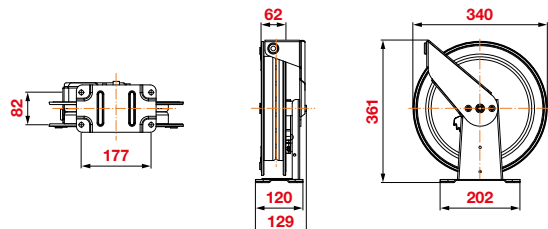

☐ N°1 packing m³ 0,045 📖 from 10,3 to 11,5 kg

Art. 735111 Standard grounding clamp 100A





SERIES 700 MOTOR-OPERATED AND MANUAL PAINTED STEEL



...for the complete range of
Industrial hose reels Series 700
ask for catalogue n. 220/700

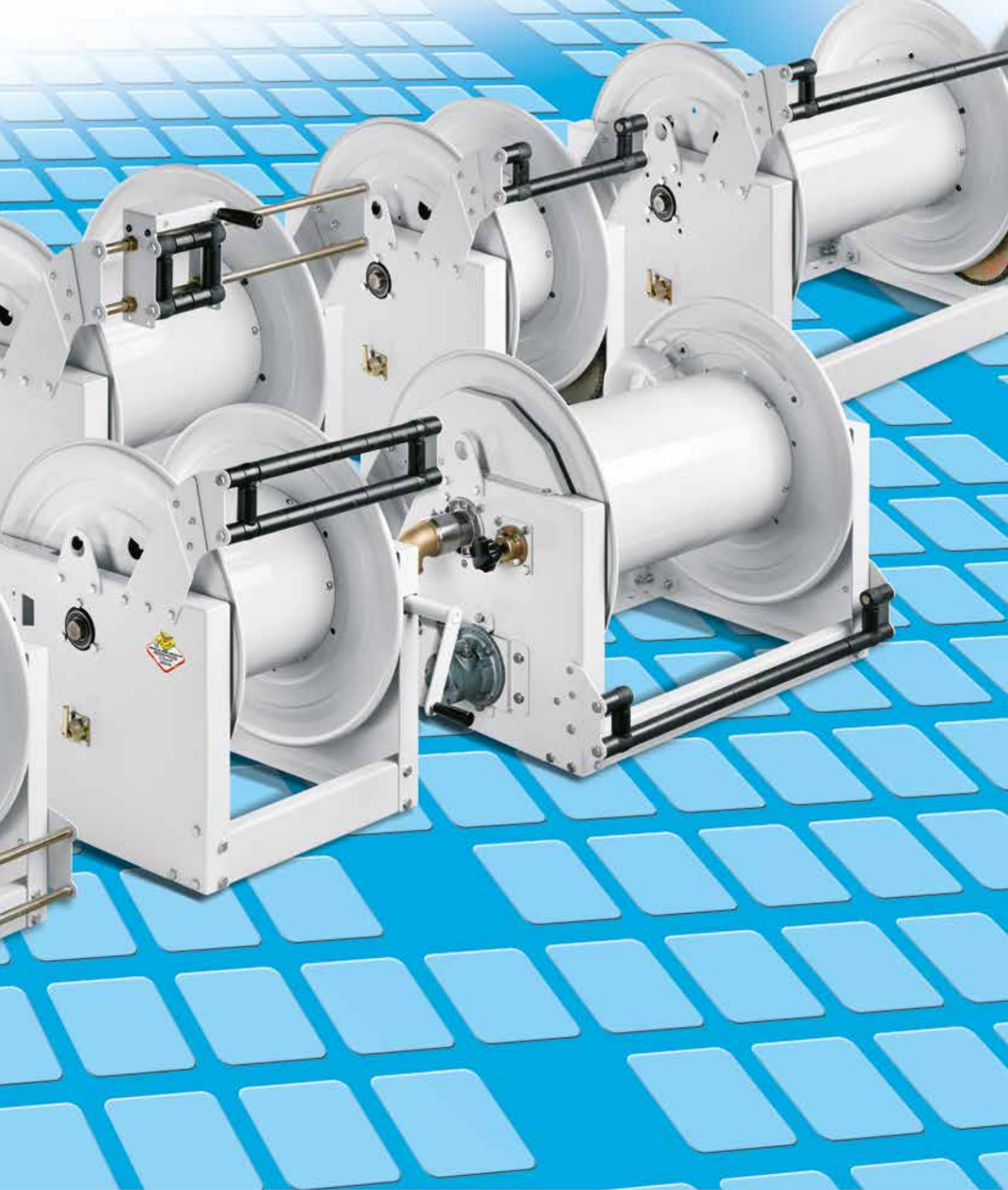

Industrial hose reels series 700 have been designed for fluids delivering in all the heavy applications of industry, mining, building construction, shipyard etc.
They are available in 4 different sizes each of them may be equipped with the following motor: **electric (high or low voltage), pneumatic, hydraulic or manual.**
They can manage hoses with max 2" I.D., max length 250 m (with 3/8" hose), suitable for max pressure of 70 bar.



wall bracket for fixed hose reels

quick fit wall brackets supplied on request



Art. 843001



Art. 843002

Art. 843001

Fixed support in steel

for fixed hose reels in painted steel
series 290 - 330 - 390 - 430

Art. 843002

Fixed support in AISI 304 stainless steel

for fixed hose reels in stainless steel and Aisi 304
series 290 - 330 - 390 - 430

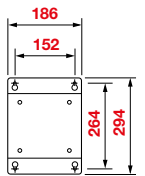

Art. 845001

Art. 845001

Fixed support in steel

for fixed enclosed hose reels in painted steel
series 450

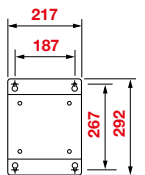

Art. 853001



Art. 853002

Art. 853001

Fixed support in steel

for fixed hose reels in painted steel
series 530

Art. 853002

Fixed support in AISI 304 stainless steel

for fixed hose reels in stainless steel and Aisi 304
series 530

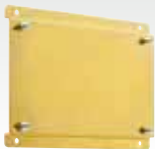
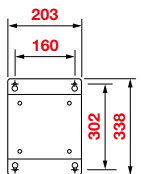

Art. 854001



Art. 854002

Art. 854001

Fixed support in steel

for fixed hose reels in painted steel
series 540

Art. 854002

Fixed support in AISI 304 stainless steel

for fixed hose reels in stainless steel and Aisi 304
series 540

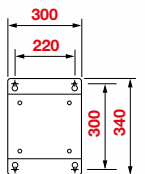

Art. 856001



Art. 856002

Art. 856001

Fixed support in steel

for fixed hose reels in painted steel
series 560

Art. 856002

Fixed support in AISI 304 stainless steel

for fixed hose reels in stainless steel and Aisi 304
series 560

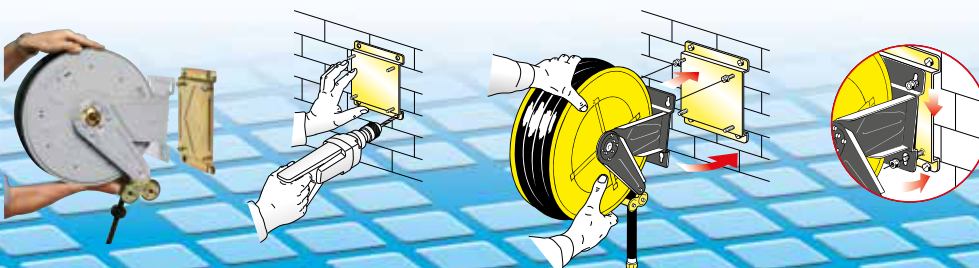
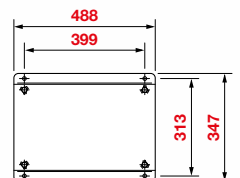

The **quick coupling support** that facilitates hooking of the single hose reels and optimises its installation in battery (i.e. with several hose reels side by side) is available by request



swivelling support for fixed hose reels

quick fit swivel brackets supplied on request



Art. 843005



Art. 843006

Art. 843005

Swivelling support in steel
for fixed hose reels in painted steel
series 290 - 330 - 390 - 430

Art. 843006

Swivelling support in AISI 304 stainless steel
for fixed hose reels in stainless steel and Aisi 304
series 290 - 330 - 390 - 430

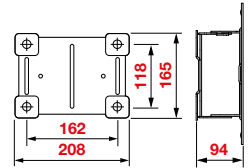

Art. 845005

Art. 845005

Swivelling support in steel
for fixed enclosed hose reels in painted steel
series 450

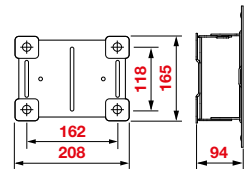

Art. 853005



Art. 853006

Art. 853005

Swivelling support in steel
for fixed hose reels in painted steel
series 530

Art. 853006

Swivelling support in AISI 304 stainless steel
for fixed hose reels in stainless steel and Aisi 304
series 530

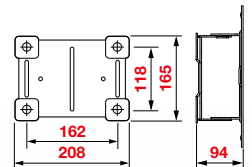

Art. 854005



Art. 854006

Art. 854005

Swivelling support in steel
for fixed hose reels in painted steel
series 540

Art. 854006

Swivelling support in AISI 304 stainless steel
for fixed hose reels in stainless steel and Aisi 304
series 540

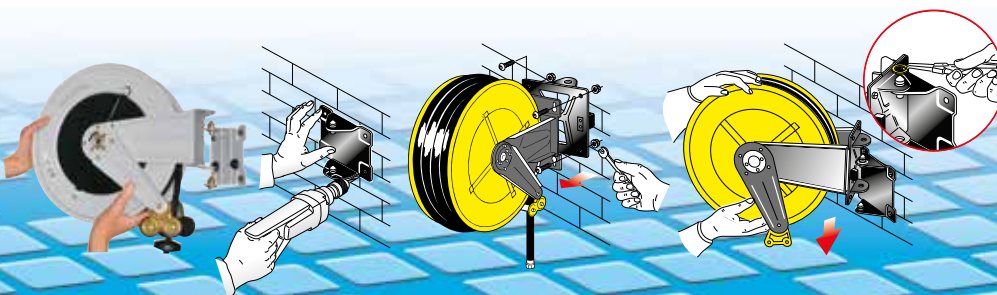
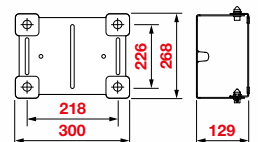

The **quick coupling swivelling support** facilitates hose reels installation and enables 40° rotation to the right or left or locking in fixed positioned at 0° by means of clamping with two screws is available by request



Hoses

technical data

Hose reels outlet hose connections fittings



- Art. **66891** Nipple in carbon steel M 1/4"G x M 1/4"G tapered/cylindrical thread
- Art. **66892** Nipple in carbon steel M 1/4"G x M 3/8"G cylindrical/cylindrical thread
- Art. **66893** Nipple in carbon steel M 1/2"G x M 1/4"G cylindrical/cylindrical thread
- Art. **33114** Nipple in carbon steel M 1"G x M 1/2"G cylindrical/cylindrical thread
- Art. **33116** Nipple in carbon steel M 1"G x M 1"G cylindrical/cylindrical thread
- Art. **33117** Nipple in carbon steel M 3/4"G x M 3/4"G cylindrical/cylindrical thread
- Art. **33119** Nipple in carbon steel M 1"G x M 3/4"G cylindrical/cylindrical thread
- Art. **33270** Nipple in carbon steel M 1.1/2"G x M 3/4"G cylindrical/cylindrical thread
- Art. **33271** Nipple in carbon steel M 1.1/2"G x M 1"G cylindrical/cylindrical thread
- Art. **33272** Nipple in carbon steel M 1.1/2"G x M 1.1/4"G cylindrical/cylindrical thread
- Art. **33273** Nipple in carbon steel M 1.1/2"G x F 1.1/4"G cylindrical/cylindrical thread
- Art. **33274** Nipple in carbon steel M 1"G x F 1/2"G cylindrical/cylindrical thread
- Art. **38071** Nipple in carbon steel M 1/2"G x M 1/2"G tapered/cylindrical thread
- Art. **38072** Nipple in carbon steel M 1/2"G x M 3/8"G cylindrical/cylindrical thread
- Art. **38073** Nipple in carbon steel M 3/8"G x M 3/8"G tapered/cylindrical thread



- Art. **33128** Nipple in AISI 304 stainless steel M 1"G x M 3/4"G cylindrical/cylindrical thread
- Art. **33129** Nipple in AISI 304 stainless steel M 1"G x M 1"G cylindrical/cylindrical thread
- Art. **33130** Nipple in AISI 304 stainless steel M 3/4"G x M 3/4"G cylindrical/cylindrical thread
- Art. **33131** Nipple in AISI 316 stainless steel M 1" x M 3/4" G cylindrical/cylindrical thread
- Art. **33132** Nipple in AISI 316 stainless steel M 1" x M 1" G cylindrical/cylindrical thread
- Art. **33133** Nipple in AISI 316 stainless steel M 1" x M 1/2" G cylindrical/cylindrical thread
- Art. **38120** Nipple in AISI 304 stainless steel M 1/2"G x M 3/8"G cylindrical/cylindrical thread
- Art. **38121** Nipple in AISI 304 stainless steel M 1/2"G x M 1/2"G cylindrical/cylindrical thread
- Art. **38123** Nipple in AISI 304 stainless steel M 1/2" x M 3/8" G tapered/cylindrical thread
- Art. **38124** Nipple in AISI 304 stainless steel M 1/2" x M 1/2" G tapered/cylindrical thread

HOSE REELS OUTLET HOSE CONNECTION

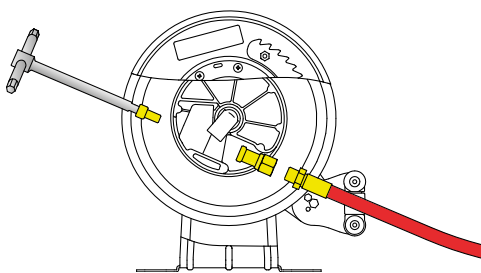

Series 290 - 330 - 380 - 390

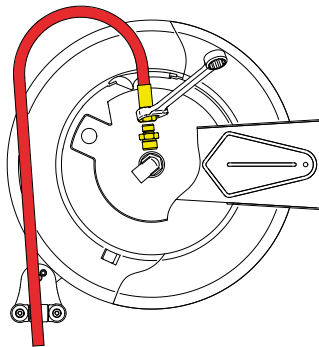

Series 420 - 430 - 520 - 530

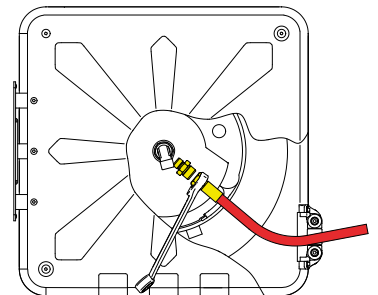

Series 440 - 450

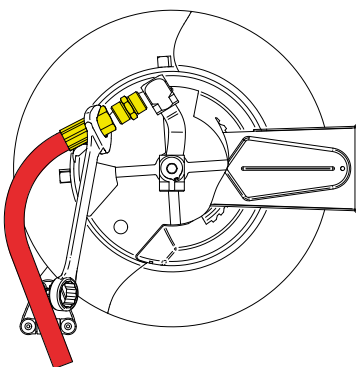

Series 540-550-560
outlet 1"

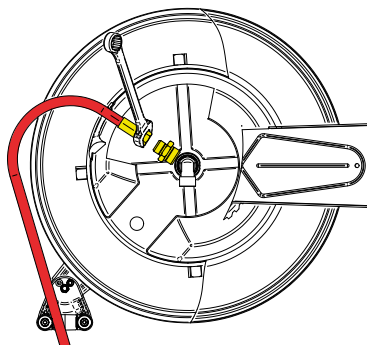

Series 540-550-560
outlet 1/2"

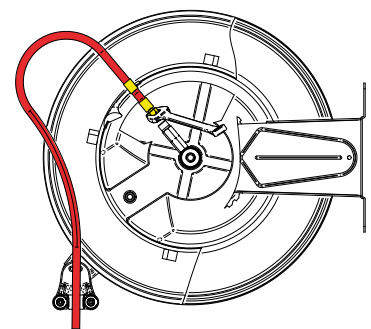

Series Welding - Natural Gas

HOSES - TECHNICAL DATA

The range of hoses offered by RAASM for its hose reels is in line with company's quality standards and guarantees excellent performance in the applications with the pressures specified in the catalogue. For conditions different from those recommended, RAASM is available to appraise every aspect of the application context (compatibility of the materials used with the fluid, temperature of use, working pressure, etc.) together with the customer for identifying the right hose for each specific case.



The hoses to be assembled on the hose reels must be suitable for the **working pressures specified on the label**.

HOSE REELS - SYSTEMS EQUIPMENT CONNECTION HOSES TABLE

Article	Hose length	Hose characteristics	Ø Hose	Dimensions (mm)	Inlet	Outlet	Pressure	Unions
967.206	0,6m	rubber EPDM antistatic	3/4"	19 x 27	F 3/4"G	M 1"G	10 bar	s/steel AISI 316
971.102	1,5m	polyurethane	5/16"	8 x 12	M 1/4"G	SNODO	20 bar	brass
975.902	1,5m	SBR/EPDM	2 x 3/8"	9 + 9x16	F 3/8"G	F 3/8"G	20 bar	brass
975.1002	1,5m	NBR/PVC	3/8"	10 x 17	F 3/8"G-Sx	F 3/8"G-Sx	20 bar	brass
972.102	1,5m	polyurethane	10 x 14,5	10 x 14,5	M 3/8"G	F 3/8"G	20 bar	brass
976.102	1,5m	polyurethane	13 x 19	13 x 19	F 1/2"G	M 1/2"G	20 bar	brass
993.201	1m	black rubber	1/4"	6,4 x 13	F 1/4"G	M 1/4"G	20 bar	galvanized steel
993.202	2m	black rubber	1/4"	6,4 x 13	F 1/4"G	M 1/4"G	20 bar	galvanized steel
995.206	0,6m	black rubber	3/8"	9,5 x 16	F 3/8"G	M 3/8"G	20 bar	galvanized steel
996.406	0,6m	hygienic cover	1/2"	12,7 x 18,5	F 1/2"G	M 1/2"G	100 bar	galvanized steel
998.406	0,6m	hygienic cover	1"	24,5 x 31,5	F 1"G	M 1"G	100 bar	galvanized steel
996.306	0,6m	black rubber	1/2"	12,7 x 19	F 1/2"G	M 1/2"G	150 bar	galvanized steel
996.301	1m	black rubber	1/2"	12,7 x 19	F 1/2"G	M 1/2"G	150 bar	galvanized steel
996.302	2m	black rubber	1/2"	12,7 x 19	F 1/2"G	F 1/2"G	150 bar	galvanized steel
996.304	4m	black rubber	1/2"	12,7 x 19	F 1/2"G	M 1/2"G	150 bar	galvanized steel
997.505	5m	black rubber	3/4"	19 x 26,5	F 3/4"G	M 3/4"G	150 bar	galvanized steel
998.3306	0,6m	black rubber	1"	25,4 x 31,5	F 1"G	M 1"G	50 bar	galvanized steel
998.501	1m	black rubber	1"	25,4 x 31,5	F 1"G	M 1"G	150 bar	galvanized steel
998.502	2m	black rubber	1"	25,4 x 31,5	F 1"G	M 1"G	150 bar	galvanized steel
995.506	0,6m	black rubber	3/8"	9,5 x 17	F 3/8"G	M 3/8"G	200 bar	galvanized steel
995.606	0,6m	hygienic cover	3/8"	9,5 x 17	F 3/8"G	M 3/8"G	200 bar	galvanized steel
995.806	0,6m	black rubber	3/8"	9,5 x 17,5	F 3/8"G	M 3/8"G	400 bar	galvanized steel
995.906	0,6m	hygienic cover	3/8"	9,5 x 17,5	F 3/8"G	M 3/8"G	400 bar	galvanized steel
993.504	4m	black rubber	1/4"	6,3 x 17,5	F 1/4"G	M 1/4"G	400 bar	galvanized steel
995.706	0,6m	black rubber	3/8"	9,5 x 18	F 3/8"G	M 3/8"G	400 bar	galvanized steel
995.701	1m	black rubber	3/8"	9,5 x 18	F 3/8"G	M 3/8"G	400 bar	galvanized steel
995.702	2m	black rubber	3/8"	9,5 x 18	F 3/8"G	M 3/8"G	400 bar	galvanized steel



Hoses

technical data

Air
Water
20 bar

Fittings
Galvanized steel
for black rubber hoses

Brass
for polyurethane hoses

Article	Hose length	Hose characteristics	ø Hose	Dimensions (mm)	Inlet	Outlet
971.010	10m	polyurethane	1/4"	6 x 10	M 3/8"G	M 1/4"G
971.011	11m	polyurethane	1/4"	6 x 10	M 1/4"G	M 1/4"G
971.015	15m	polyurethane	1/4"	6 x 10	M 3/8"G	M 1/4"G
971.111	11m	polyurethane	5/16"	8 x 12	M 1/4"G	M 1/4"G
971.115	15m	polyurethane	5/16"	6 x 12	M 3/8"G	M 1/4"G
971.118	18m	polyurethane	5/16"	8 x 12	M 3/8"G	M 1/4"G
971.120	20m	polyurethane	5/16"	8 x 12	M 3/8"G	M 1/4"G
972.113	13m	polyurethane	3/8"	10 x 14,5	M 3/8"G	M 3/8"G
972.115	15m	polyurethane	3/8"	10 x 14,5	M 3/8"G	M 3/8"G
972.120	20m	polyurethane	3/8"	10 x 14,5	M 3/8"G	M 3/8"G
976.108	8m	polyurethane	1/2"	13 x 19	M 1/2"G	M 1/2"G
976.110	10m	polyurethane	1/2"	13 x 19	M 1/2"G	M 1/2"G
976.111	10m	polyurethane	1/2"	13 x 19	F 1/2"G	M 1/2"G
976.112	12m	polyurethane	1/2"	13 x 19	M 1/2"G	M 1/2"G
976.114	15m	polyurethane	1/2"	13 x 19	M 1/2"G	M 1/2"G
976.115	15m	polyurethane	1/2"	13 x 19	F 1/2"G	M 1/2"G
993.215	15m	black rubber	1/4"	6,5 x 12,6	M 3/8"G	M 1/4"G
995.210	10m	black rubber	3/8"	9,5 x 17	M 3/8"G	M 3/8"G
995.211	12m	black rubber	3/8"	9,5 x 16	M 3/8"G	M 3/8"G
995.212	12m	black rubber	3/8"	9,5 x 16	F 3/8"G	M 3/8"G
995.217	18m	black rubber	3/8"	9,5 x 16	M 3/8"G	M 3/8"G
995.218	18m	black rubber	3/8"	9,5 x 16	F 3/8"G	M 3/8"G
996.210	10m	black rubber	1/2"	12,7 x 20	F 1/2"G	M 1/2"G
996.215	15m	black rubber	1/2"	12,7 x 20	F 1/2"G	M 1/2"G
996.220	20m	black rubber	1/2"	12,7 x 20	F 1/2"G	M 1/2"G
996.225	25m	black rubber	1/2"	12,7 x 20	F 1/2"G	M 1/2"G
996.230	30m	black rubber	1/2"	12,7 x 20	F 1/2"G	M 1/2"G
997.215	15m	black rubber	3/4"	19 x 26,5	F 3/4"G	M 3/4"G
997.220	20m	black rubber	3/4"	19 x 26,5	F 3/4"G	M 3/4"G
997.230	30m	black rubber	3/4"	19 x 26,5	F 3/4"G	M 3/4"G
997.240	40m	black rubber	3/4"	19 x 26,5	F 3/4"G	M 3/4"G
998.215	15m	black rubber	1"	25,4 x 32,5	F 1"G	M 1"G
998.220	20m	black rubber	1"	25,4 x 32,5	F 1"G	M 1"G
998.230	30m	black rubber	1"	25,4 x 32,5	F 1"G	M 1"G

Water
max 130 °C
100 bar
* **50 bar**

Fittings
Galvanized steel

Article	Hose length	Hose characteristics	ø Hose	Dimensions (mm)	Inlet	Outlet
995.313	12m	black rubber	3/8"	9,5 x15	M 3/8"G	M 3/8"G
995.318	17m	black rubber	3/8"	9,5 x15	M 3/8"G	M 3/8"G
995.412	12m	hygienic cover	3/8"	9,5 x15	M 3/8"G	M 3/8"G
996.311	10m	black rubber	1/2"	12,7 x 18,5	F 1/2"G	M 1/2"G
996.316	15m	black rubber	1/2"	12,7 x 18,5	F 1/2"G	M 1/2"G
996.321	20m	black rubber	1/2"	12,7 x 18,5	F 1/2"G	M 1/2"G
996.415	15m	hygienic cover	1/2"	12,7 x 18,5	F 1/2"G	M 1/2"G
996.425	25m	hygienic cover	1/2"	12,7 x 18,5	F 1/2"G	M 1/2"G
997.320	20m	black rubber	3/4"	19 x 25	F 3/4"G	M 3/4"G
997.420	20m	hygienic cover	3/4"	19 x 25	F 3/4"G	M 3/4"G
998.315	15m	black rubber	1"	25,4 x 31,5	F 1"G	M 1"G
998.330	30m	black rubber	1"	25,4 x 31,5	F 1"G	M 1"G



Hoses

technical data

Water
max 130 °C
200 bar

Fittings
Galvanized steel

Article	Hose length	Hose characteristics	ø Hose	Dimensions (mm)	Inlet	Outlet
994.512	12m	black rubber	5/16"	8 x 15	M 3/8"G	F 3/8"G
994.517	17m	black rubber	5/16"	8 x 15	M 3/8"G	F 3/8"G
994.612	12m	hygienic cover	5/16"	8 x 15	M 3/8"G	F 3/8"G
995.512	12m	black rubber	3/8"	9,5 x 17	F 3/8"G	F 3/8"G
995.518	18m	black rubber	3/8"	9,5 x 17	F 3/8"G	F 3/8"G
995.520	20m	black rubber	3/8"	9,5 x 17	F 3/8"G	F 3/8"G
995.525	25m	black rubber	3/8"	9,5 x 17	F 3/8"G	F 3/8"G
995.530	30m	black rubber	3/8"	9,5 x 17	F 3/8"G	F 3/8"G
995.540	40m	black rubber	3/8"	9,5 x 17	F 3/8"G	F 3/8"G
995.550	50m	black rubber	3/8"	9,5 x 17	F 3/8"G	F 3/8"G
995.618	18m	hygienic cover	3/8"	9,5 x 17	F 3/8"G	F 3/8"G
995.625	25m	hygienic cover	3/8"	9,5 x 17	F 3/8"G	F 3/8"G
995.630	30m	hygienic cover	3/8"	9,5 x 17	F 3/8"G	F 3/8"G

Water
max 130 °C
400 bar

Fittings
Galvanized steel

Article	Hose length	Hose characteristics	ø Hose	Dimensions (mm)	Inlet	Outlet
994.717	17m	black rubber	5/16"	8 x 16	M 3/8"G	F 3/8"G
995.815	15m	black rubber	3/8"	9,5 x 17,5	F 3/8"G	F 3/8"G
995.825	25m	black rubber	3/8"	9,5 x 17,5	F 3/8"G	F 3/8"G
995.915	15m	hygienic cover	3/8"	9,5 x 17,5	F 3/8"G	F 3/8"G
995.925	25m	hygienic cover	3/8"	9,5 x 17,5	F 3/8"G	F 3/8"G

Oil and similar products
150 bar
* **50 bar**
** **100 bar**

Fittings
Galvanized steel

Article	Hose length	Hose characteristics	ø Hose	Dimensions (mm)	Inlet	Outlet
995.312	12m	black rubber	3/8"	9,5 x 17	M 3/8"G	M 1/2"G
995.317	17m	black rubber	3/8"	9,5 x 17	M 3/8"G	M 1/2"G
996.310	10m	black rubber	1/2"	12,7 x 19	F 1/2"G	M 1/2"G
996.315	15m	black rubber	1/2"	12,7 x 19	F 1/2"G	M 1/2"G
996.320	20m	black rubber	1/2"	12,7 x 19	F 1/2"G	M 1/2"G
996.325	25m	black rubber	1/2"	12,7 x 19	F 1/2"G	M 1/2"G
996.330	30m	black rubber	1/2"	12,7 x 19	F 1/2"G	M 1/2"G
997.3315	15m	black rubber	3/4" *	19 x 26,5	F 3/4"G	M 3/4"G
997.3320	20m	black rubber	3/4" *	19 x 26,5	F 3/4"G	M 3/4"G
998.3315	15m	black rubber	1" **	25,4 x 35,5	F 1"G	M 1"G
998.3330	30m	black rubber	1" **	25,4 x 35,5	F 1"G	M 1"G

Grease
400 bar

Fittings
Galvanized steel

Article	Hose length	Hose characteristics	ø Hose	Dimensions (mm)	Inlet	Outlet
993.511	12m	black rubber	1/4"	6,3 x 17,5	M 3/8"G	M 1/4"G
993.512	12m	black rubber	1/4"	6,3 x 17,5	F 1/4"G	M 1/4"G
993.516	16m	black rubber	1/4"	6,3 x 17,5	M 3/8"G	M 1/4"G
993.518	18m	black rubber	1/4"	6,3 x 17,5	F 1/4"G	M 1/4"G
995.710	10m	black rubber	3/8"	9,5 x 18	F 3/8"G	M 1/4"G
995.715	15m	black rubber	3/8"	9,5 x 18	F 3/8"G	M 1/4"G
995.720	20m	black rubber	3/8"	9,5 x 18	F 3/8"G	M 1/4"G
995.725	25m	black rubber	3/8"	9,5 x 18	F 3/8"G	M 1/4"G
995.730	30m	black rubber	3/8"	9,5 x 18	F 3/8"G	M 1/4"G



Hoses

technical data

Diesel fuel
10 bar

Fittings
Galvanized steel

Article	Hose length	Hose characteristics	ø Hose	Dimensions (mm)	Inlet	Outlet
997.812	12m	black rubber	3/4"	19 x 27	F 1/2"G	M 1/2"G
997.815	15m	black rubber	3/4"	19 x 27	F 3/4"G	M 3/4"G
997.820	20m	black rubber	3/4"	19 x 27	F 3/4"G	M 3/4"G
997.840	40m	black rubber	3/4"	19 x 27	F 3/4"G	M 3/4"G
998.808	8m	black rubber	1"	25 x 35	F 1"G	M 1"G
998.815	15m	black rubber	1"	25 x 35	F 1"G	M 1"G
998.820	20m	black rubber	1"	25 x 35	F 1"G	M 1"G
998.830	30m	black rubber	1"	25 x 35	F 1"G	M 1"G

AdBlue®
10 bar

Fittings
AISI 316
Stainless steel

Article	Hose length	Hose characteristics	ø Hose	Dimensions (mm)	Inlet	Outlet
967.210	10m	rubber EPDM antistatic	3/4"	19 x 27	F 3/4"G	M 3/4"G
967.215	15m	rubber EPDM antistatic	3/4"	19 x 27	F 3/4"G	M 3/4"G

Welding
20 bar
EN 559

Fittings
Brass

Article	Hose length	Hose characteristics	ø Hose	Dimensions (mm)	Inlet	Outlet
973.913	13m	SBR/EPDM	2x1/4"	6,3 + 6,3x13	F 3/8"G	M 3/8"G
973.917	17m	SBR/EPDM	2x1/4"	6,3 + 6,3x13	F 3/8"G	F 3/8"G
973.920	20m	SBR/EPDM	2x1/4"	6,3 + 6,3x13	F 3/8"G	F 3/8"G
973.925	25m	SBR/EPDM	2x1/4"	6,3 + 6,3x13	F 3/8"G	F 3/8"G
973.930	30m	SBR/EPDM	2x1/4"	6,3 + 6,3x13	F 3/8"G	F 3/8"G
974.912	12m	SBR/EPDM	2x5/16"	8 + 8x15	F 3/8"G	F 3/8"G
974.915	15m	SBR/EPDM	2x5/16"	8 + 8x15	F 3/8"G	F 3/8"G
974.920	20m	SBR/EPDM	2x5/16"	8 + 8x15	F 3/8"G	F 3/8"G
974.925	25m	SBR/EPDM	2x5/16"	8 + 8x15	F 3/8"G	F 3/8"G
974.930	30m	SBR/EPDM	2x5/16"	8 + 8x15	F 3/8"G	F 3/8"G
975.915	15m	SBR/EPDM	2x3/8"	9 + 9x16	F 3/8"G	F 3/8"G
975.920	20m	SBR/EPDM	2x3/8"	9 + 9x16	F 3/8"G	F 3/8"G
975.927	27m	SBR/EPDM	2x3/8"	9 + 9x16	F 3/8"G	F 3/8"G

Lpg and
Natural gas
20 bar
EN 559

Fittings
Brass

Article	Hose length	Hose characteristics	ø Hose	Dimensions (mm)	Inlet	Outlet
974.1008	8m	NBR/PVC	5/16"	8 x 15	F 3/8"G-Sx	F 3/8"G-Sx
974.1015	15m	NBR/PVC	5/16"	8 x 15	F 3/8"G-Sx	F 3/8"G-Sx
974.1020	20m	NBR/PVC	5/16"	8 x 15	F 3/8"G-Sx	F 3/8"G-Sx
974.1028	28m	NBR/PVC	5/16"	8 x 15	F 3/8"G-Sx	F 3/8"G-Sx
975.1010	10m	NBR/PVC	3/8"	10 x 17	F 3/8"G-Sx	F 3/8"G-Sx
975.1015	15m	NBR/PVC	3/8"	10 x 17	F 3/8"G-Sx	F 3/8"G-Sx
975.1018	18m	NBR/PVC	3/8"	10 x 17	F 3/8"G-Sx	F 3/8"G-Sx
975.1027	27m	NBR/PVC	3/8"	10 x 17	F 3/8"G-Sx	F 3/8"G-Sx
975.1030	30m	NBR/PVC	3/8"	10 x 17	F 3/8"G-Sx	F 3/8"G-Sx



INDUSTRIAL PUMPS





RAASM INDUSTRIAL

FLUIDS AND LUBRICATION EQUIPMENT

Industrial Pumps

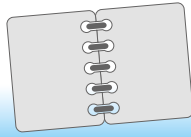

INTRODUCTION

page **190**



PUMPS FOR OILS AND SIMILAR PRODUCTS

page **196**



HIGH FLOW PUMPS FOR OIL AND SIMILAR PRODUCTS

page **200**



GREASE PUMPS

page **202**



PUMPS FOR INDUSTRIAL FLUIDS

page **206**



AISI 304 STAINLESS STEEL PUMPS

page **208**

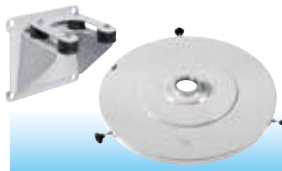

ACCESSORIES

page **210**



PUMP ELEVATORS AND RAM

page **212**



Total Quality



Innovative design for optimising the pump work cycle.
The result of years of research and development, during which numerous tests were carried out for thousands of work hours.

High quality materials used, cutting-edge processes, hardening and grinding for reducing internal friction and limiting wear.

Fewer moving parts for easy and occasional maintenance with savings in running costs.

The industrial pumps guarantee high efficiency in capacity and operating pressure.

Double action ensures a continuous and constant flow of the fluid delivered.

Versatility

INTEGRAL INDUSTRIAL PUMPS



Air motor and pumping unit form a single body. They are recommended for transferring non-corrosive fluids, oil and allied products.

FLANGED INDUSTRIAL PUMPS



Air motor and pumping unit form a single body. They are recommended for transferring non-corrosive fluids, oil and allied products. The motor base is flanged to enable application of the handles which are useful for easy moving and for simple fixing in various other applications.

DIVORCED INDUSTRIAL PUMPS



Air motor and pumping unit are separate so that the fluid cannot come into direct contact with the motor body. They are recommended for transferring non-aggressive industrial and chemical fluids. The motor base is flanged to enable application of the handles which are useful for easy moving and for simple fixing in various other applications.

The **integral pumps** and **flanged pumps** are available in the drum version and modular version (modular = extendable with a rigid suction tube, or in the wall application with a flexible suction tube)



Examples of industrial pump applications

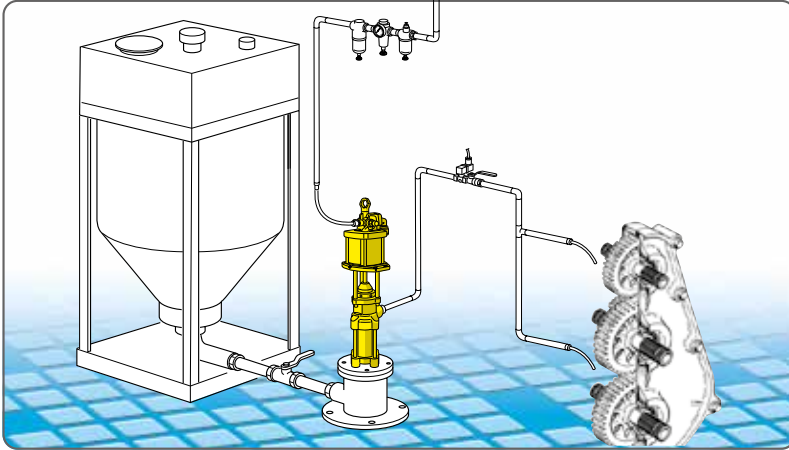

Stations for continuous feed of machinery by means of distribution of fluids in line (lubricants, inks, adhesives, etc.) with pump connected to the tank or fixed to the floor with bracket.

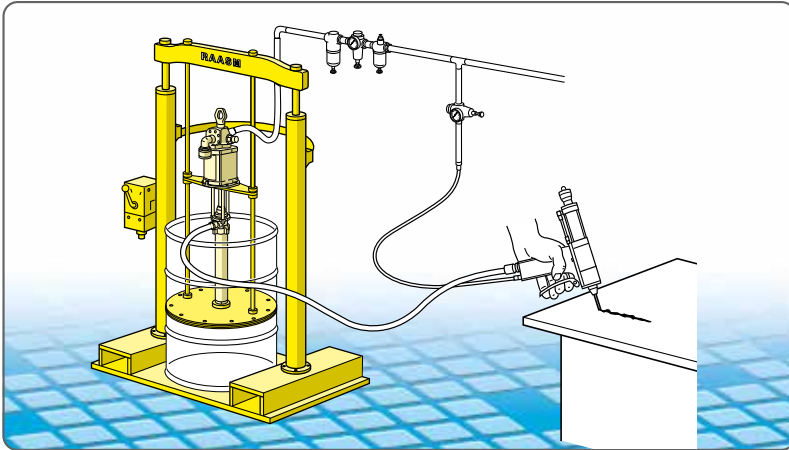

Automated system for the delivery of preselected quantities of fluids (inks, paints, greases, etc.), fed by pumps mounted on drum, with lift.

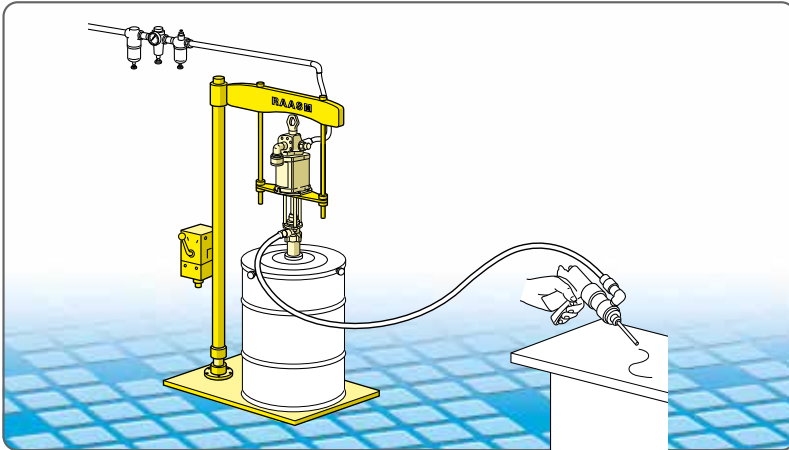

Application of sealants, adhesives, greases, etc., by means of special delivery gun fed by pump mounted on drum in fixed or mobile station.

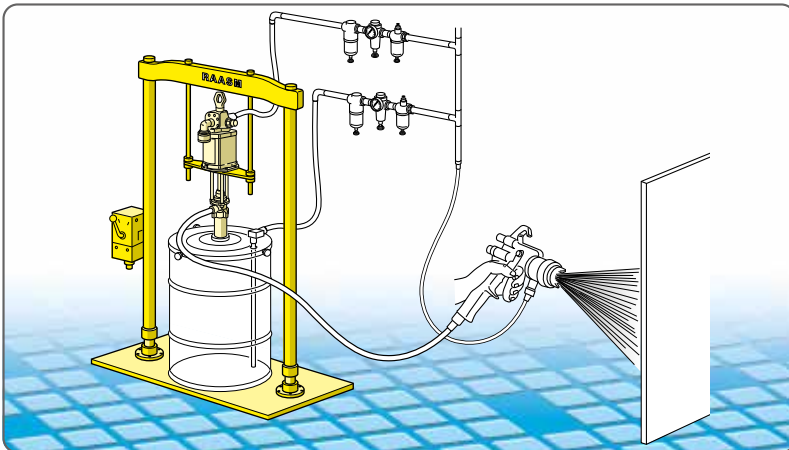

Fluid distribution system (for paints, lubricants, protective liquids, etc.) fed by pump mounted on drum in fixed station and delivery with spray gun.



Industrial pump installations on tanks or drums

For tank with pump in vertical position mounted on bracket

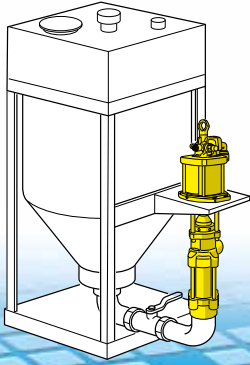

For tank with pump in vertical position mounted on floor with bracket

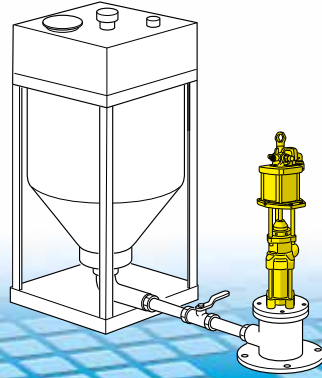

For tank with pump in horizontal position

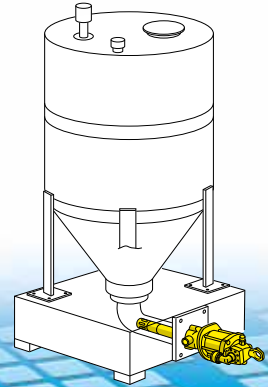

For tank with pump in inclined position

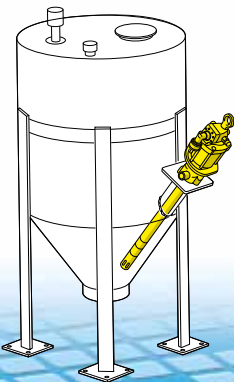

For 200 kg drum, with double ram hoist and follower

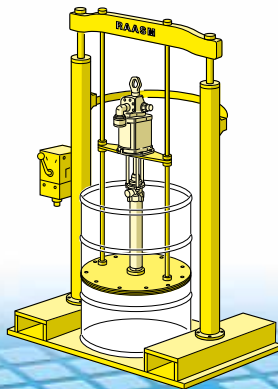

For 200 kg drums, standard application

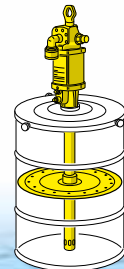

Industrial pumps installed on vertical bulk containers

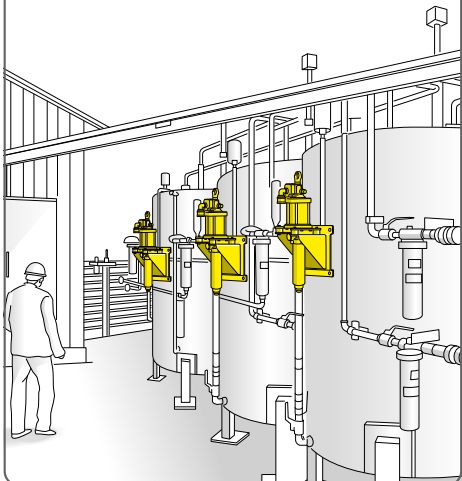

Industrial pumps installed on pedestals connected to horizontal bulk containers

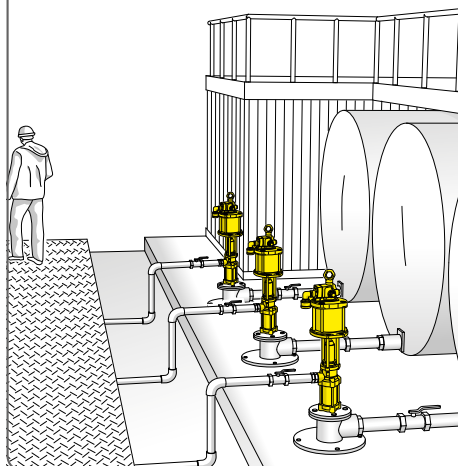

Bank of pumps connected with bulk containers

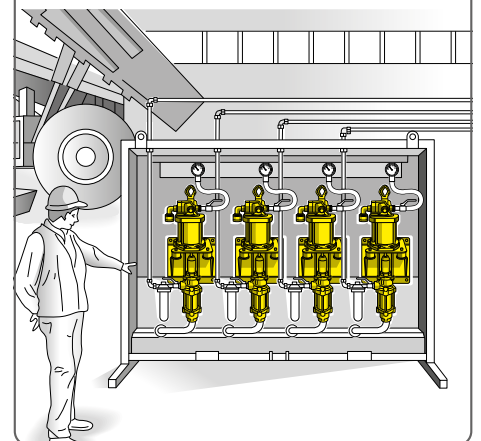



...everything for mining
technology, quality, functionality

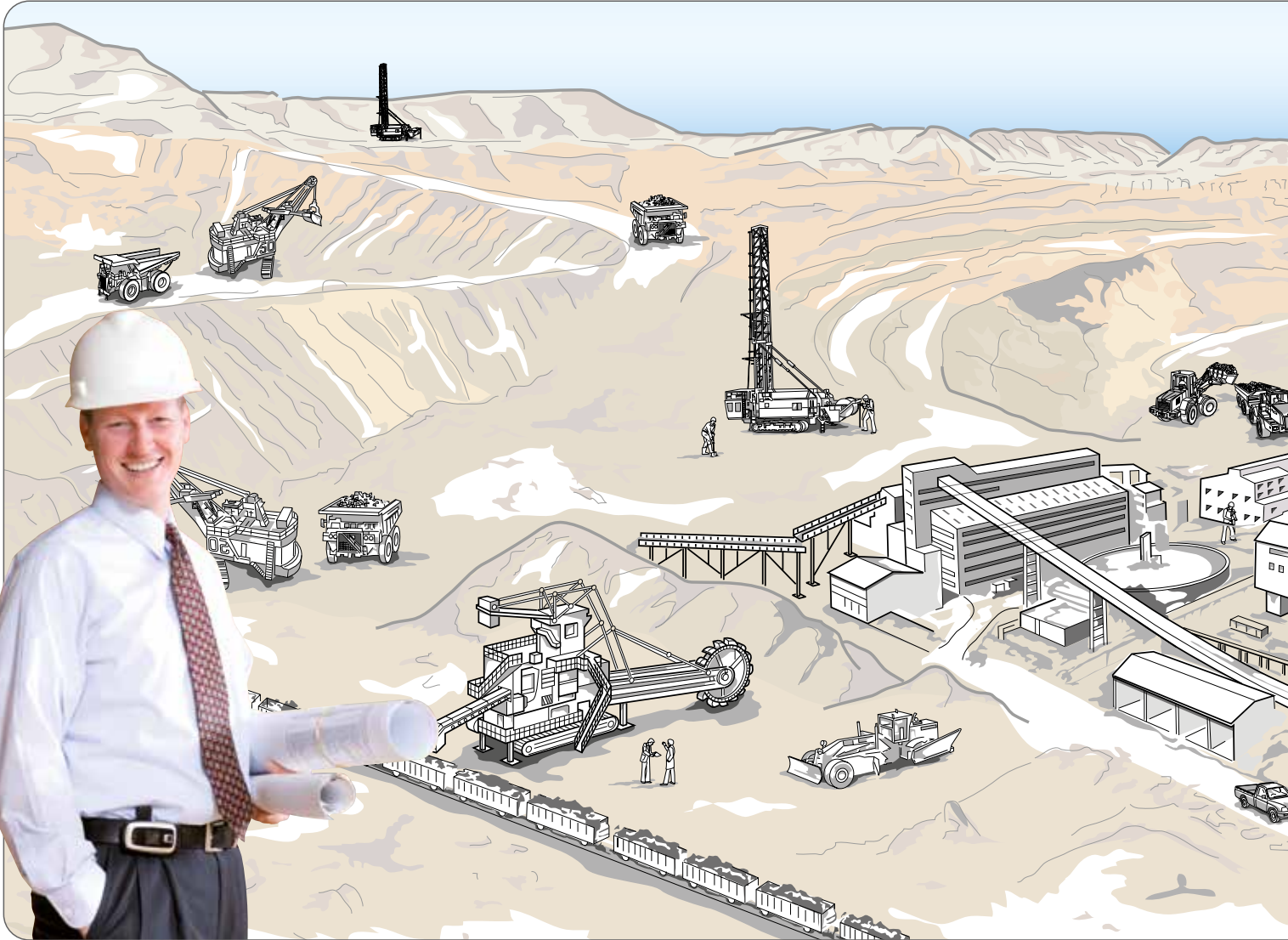

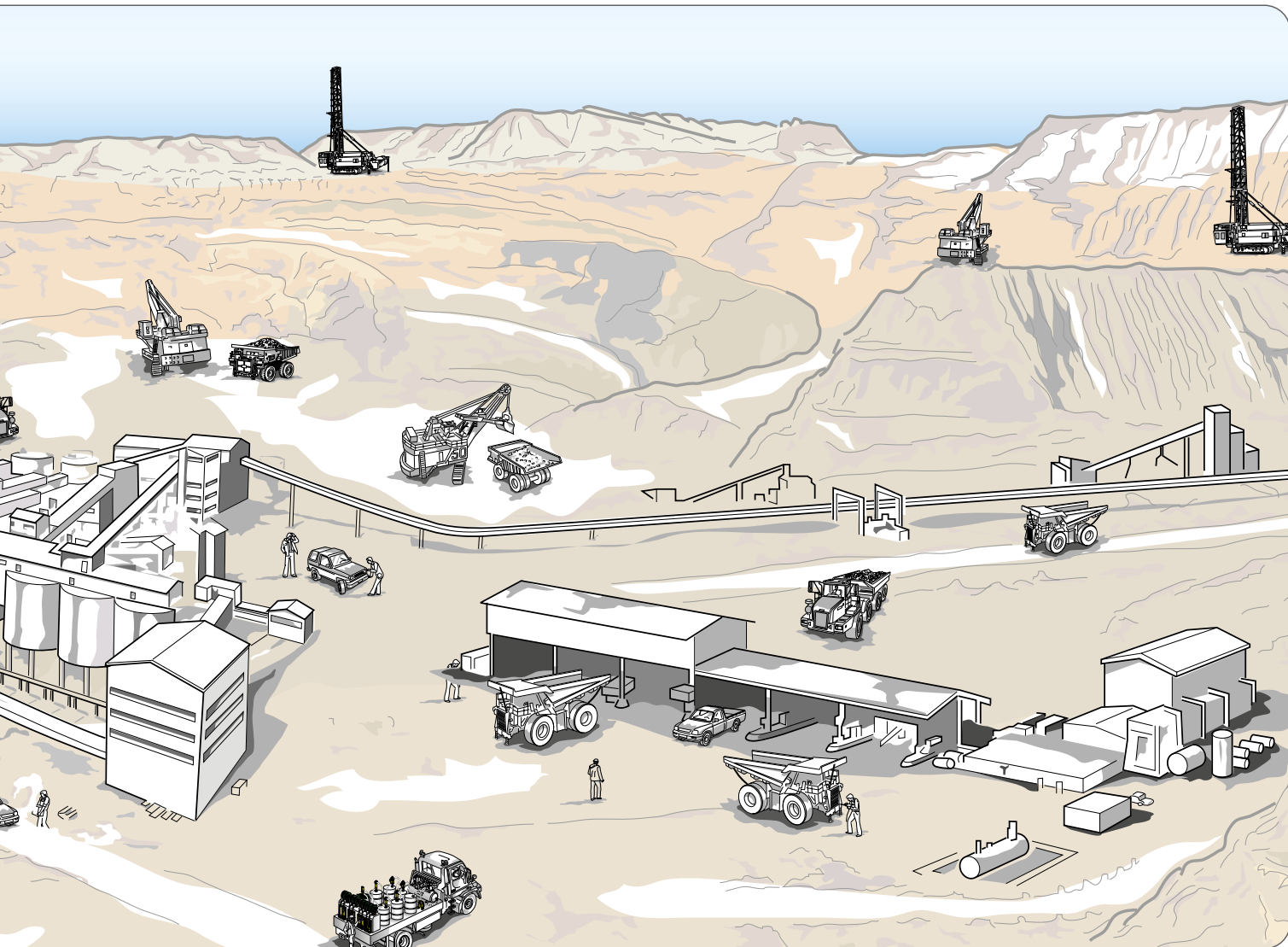



Air-operated INDUSTRIAL PUMPS

oil and similar products

Ratio **5:1**
Flow rate **45 l/min**

Double action series 900 air-operated industrial pumps for distribution.

Suitable for transferring oils, lubricants and similar products, also high viscosity. The double action guarantees the delivery of a continuous and constant flow. Ideal for every needs. Particularly effective in systems equipped with several dispensing points.



series **900**

Article with seals in	PU
Compatible fluids	Oils, lubricants and similar
Suction tube upper body	Aluminium
Suction tube	Carbon steel
Air inlet connection	bsp F 1/2"
Fluid outlet connection	bsp F 3/4"
Max. air consumption 8 bar	m ³ /min 1,6
Noise level	dB 80
Air max. feed pressure	bar 8

Suitable for drums or tanks

Packing	N° - m ³
Weight	kg
Dimensions (A - B - C)	cm





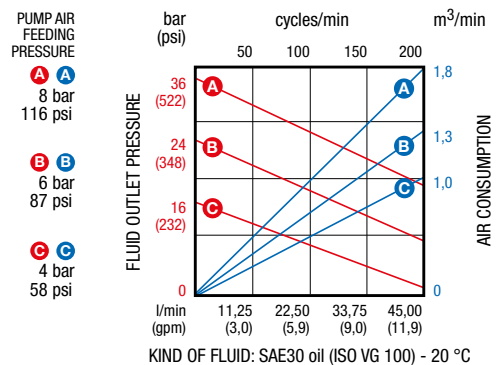

	integral 90C/51	flanged 90F/51
Compatible fluids	Oils, lubricants and similar	
Suction tube upper body	Aluminium	
Suction tube	Carbon steel	
Air inlet connection	F 1/2"	F 1/2"
Fluid outlet connection	F 3/4"	F 3/4"
Max. air consumption 8 bar	1,6	1,6
Noise level	80	80
Air max. feed pressure	8	8
modular		
Packing	1 - 0,040	1 - 0,040
Weight	12	13
Dimensions (A - B - C)	43 - 27 - 6,2	44,5 - 27 - 6,2

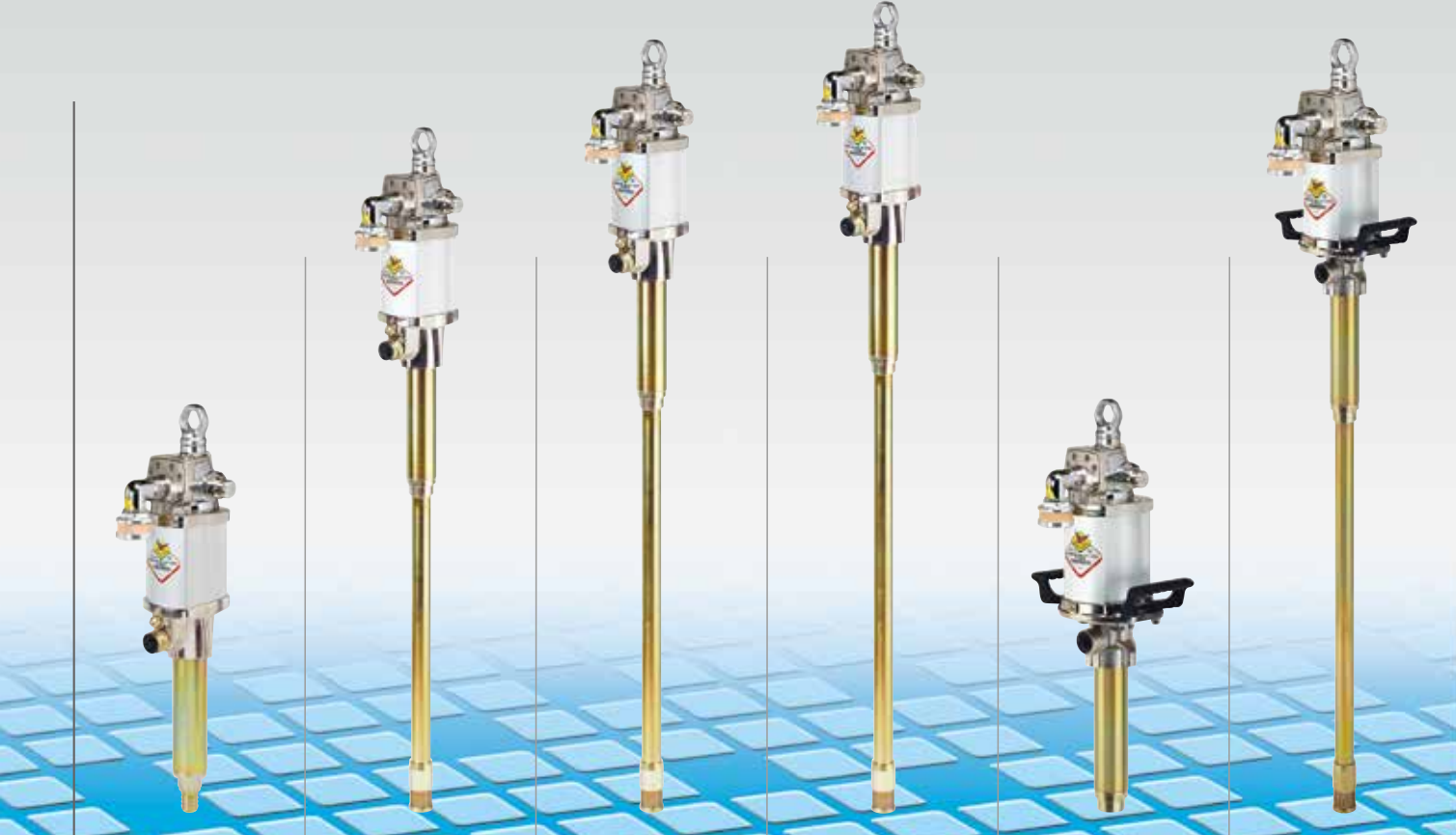

Ratio 7:1
Flow rate 30 l/min

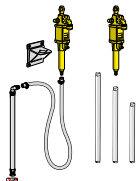
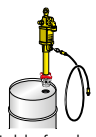

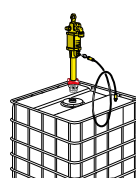
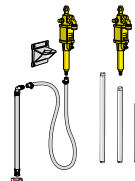
series 900

integral	integral	integral	integral	flanged	flanged
90C/71	93C/71	91C/71	92C/71	90F/71	91F/71
Oils, lubricants and similar				Oils, lubricants and grease	
Aluminium				Carbon steel	
Carbon steel				Carbon steel	
F 1/2"	F 1/2"	F 1/2"	F 1/2"	F 1/2"	F 1/2"
F 3/4"	F 3/4"	F 3/4"	F 3/4"	F 3/4"	F 3/4"
1,6	1,6	1,6	1,6	1,6	1,6
80	80	80	80	80	80
8	8	8	8	8	8
					
modular	suitable for drums 50-60 kg	suitable for drums 180-220 kg	tank	modular	suitable for drums 180-220 kg
1 - 0,040	1 - 0,080	1 - 0,080	1 - 0,080	1 - 0,040	1 - 0,070
11	13,5	14,5	15	12	14
43 - 27 - 5,3	43 - 74 - 5,3	43 - 94 - 5,3	43 - 126 - 5,3	44,5 - 27 - 5,3	44,5 - 94 - 5,3

PUMP AIR FEEDING PRESSURE

- A** 8 bar 116 psi
- B** 6 bar 87 psi
- C** 4 bar 58 psi

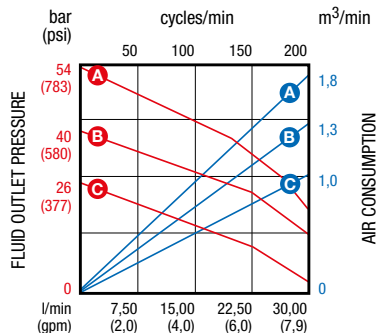

KIND OF FLUID: SAE30 oil (ISO VG 100) - 20 °C



Air-operated INDUSTRIAL PUMPS





oil and similar products

Ratio **11:1**
Flow rate **30 l/min**

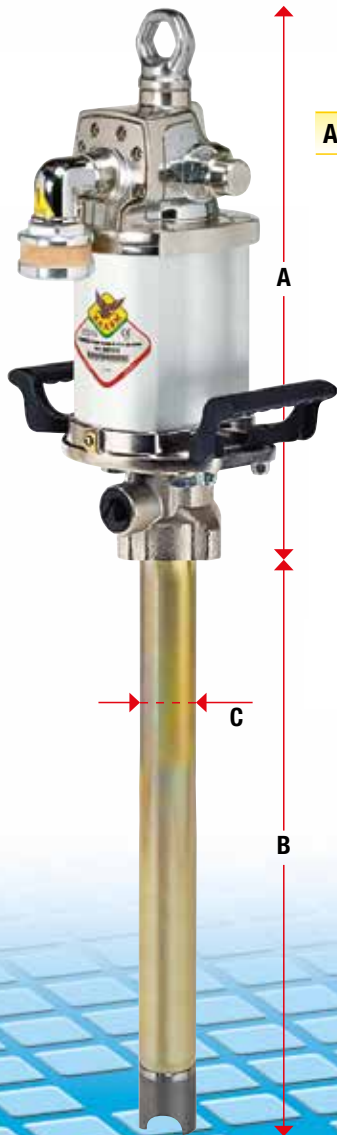
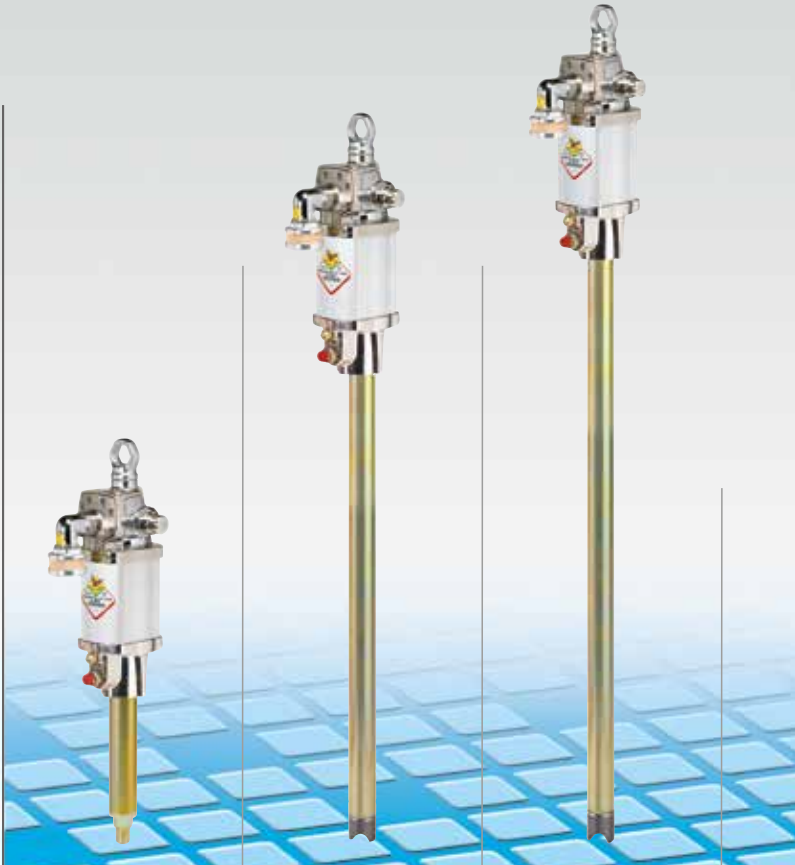
Double action series 900 and 1200 air-operated industrial pumps for distribution.

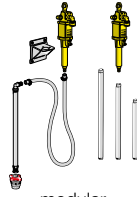
Suitable for transferring oils, lubricants and similar products, also high viscosity. the double action guarantees the delivery of a continuous and constant flow. Ideal for every needs. Particularly effective in systems equipped with several dispensing points.



Article with seals in	PU	90C/111	92C/111	91C/111
Compatible fluids		Oils, lubricants and grease		
Suction tube upper body		Aluminium		
Suction tube		Carbon steel		
Air inlet connection	bsp	F 1/2"	F 1/2"	F 1/2"
Fluid outlet connection	bsp	F 3/4"	F 3/4"	F 3/4"
Max. air consumption 8 bar	m ³ /min	1,7	1,7	1,7
Noise level	dB	80	80	80
Air max. feed pressure	bar	8	8	8
Suitable for drums or tanks		 modular	 suitable for drums 50-60 kg	 suitable for drums 180-220 kg
Packing	 N° - m ³	1 - 0,040	1 - 0,070	1 - 0,070
Weight	 kg	11	15	16
Dimensions (A - B - C)	cm	43 - 27 - 4,5	43 - 74 - 4,5	43 - 94 - 4,5

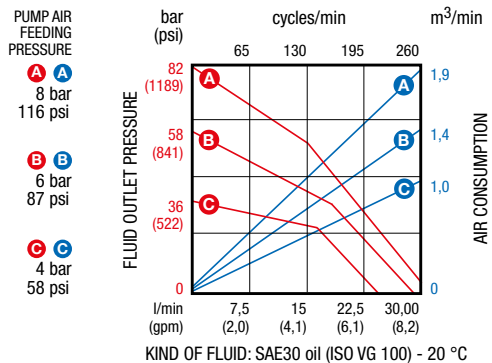



Ratio **9:1**
Flow rate **45 l/min**

Ratio **12:1**
Flow rate **30 l/min**

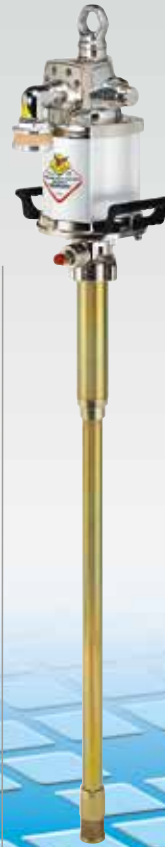
Ratio **18:1**
Flow rate **23 l/min**

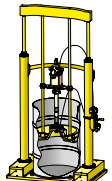
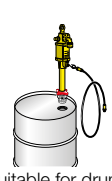

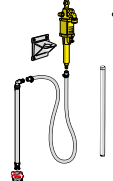
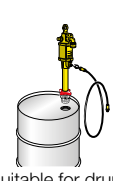
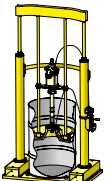
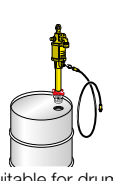
series 900		series 1200		series 1200		series 1200	
flanged		flanged		flanged		flanged	
90F/111	91F/111	115F/91	115F/121	116F/121	115F/181	116F/181	
Oils, lubricants and grease		Oils, lubricants and similar		Oils, lubricants and similar		Oils, lubricants and grease	
Carbon steel Carbon steel		Carbon steel Carbon steel		Carbon steel Carbon steel		Carbon steel Carbon steel	
F 1/2"	F 1/2"	F 1/2"	F 1/2"	F 1/2"	F 1/2"	F 1/2"	F 1/2"
F 3/4"	F 3/4"	F 3/4"	F 3/4"	F 3/4"	F 3/4"	F 3/4"	F 3/4"
1,7	1,7	2,8	2,8	2,8	2,8	2,8	2,8
80	80	80	80	80	80	80	80
8	8	8	8	8	8	8	8
							
1 - 0,045	1 - 0,070	1 - 0,40	1 - 0,040	1 - 0,070	1 - 0,045	1 - 0,070	
13	17	14	13	15	15,5	18	
44,5 - 48 - 4,5	44,5 - 94 - 4,5	44,5 - 23 - 6,2	44,5 - 23 - 5,3	44,5 - 94 - 5,3	44,5 - 48 - 4,5	44,5 - 94 - 4,5	

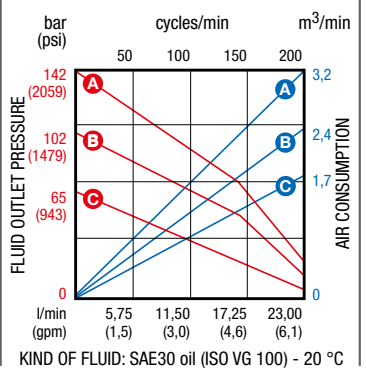
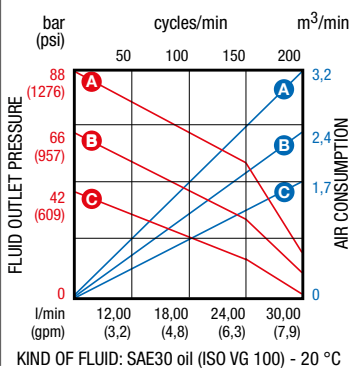
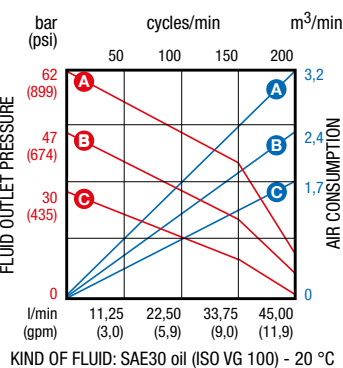
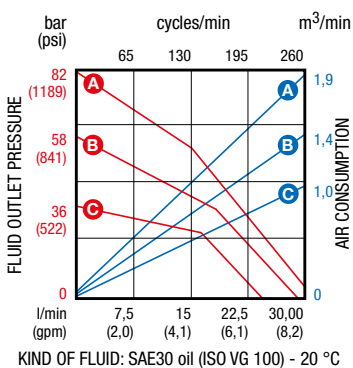



Air-operated INDUSTRIAL PUMPS

oil and similar products

Series 900, 1200, 1500 and 1800 industrial air-operated pumps for medium-long distance distribution. Suitable for transferring oils, lubricants and similar products, they guarantee high performance in capacity (l/min) and operating pressure. The version with Viton® seals can also be used for the transfer of industrial and chemical fluids. The high quality of the components ensures lasting and reliable operation even in extreme conditions.

Ratio 2:1
Flow rate **95 l/min**

Ratio 3:1
Flow rate **100 l/min**



series 900 divorced **series 1200** divorced

Article with seals in PU	90D/21		115D/31	
Article with seals in Viton®		90DV/21		115DV/31
Compatible fluids	Oils, lubricants and similar	Chemical and industrial fluids	Oils, lubricants and similar	Chemical and industrial fluids
Suction tube upper body	Carbon steel		Carbon steel	
Suction tube	Carbon steel		Carbon steel	
Air inlet connection	bsp F 1/2"	F 1/2"	F 1/2"	F 1/2"
Fluid outlet connection	bsp F 1.1/2"	F 1.1/2"	F 1.1/2"	F 1.1/2"
Max. air consumption 8 bar	m³/min 1,6	1,6	2,8	2,8
Noise level	dB 80	80	80	80
Air max. feed pressure	bar 8	8	8	8

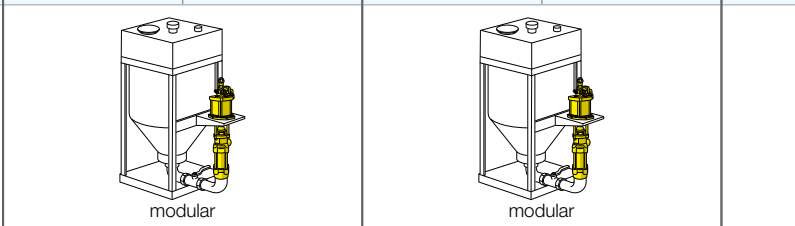

Packing	N° - m³ 1 - 0,20	1 - 0,20	1 - 0,20	1 - 0,20
Weight	kg 45	45	46	46
Dimensions (A - B - C)	cm 36 - 62,5 - 16,2	36 - 62,5 - 16,2	36 - 62,5 - 16,2	36 - 62,5 - 16,2

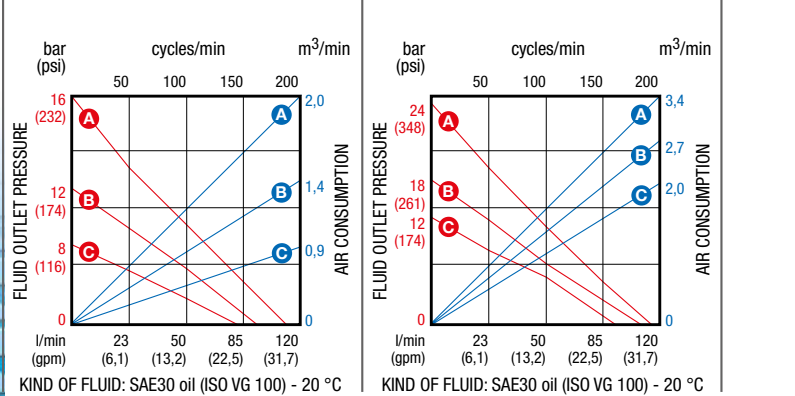

Article with seals in PU	
Article with seals in Viton®	
Compatible fluids	Oils, lubricants and similar
Suction tube upper body	Carbon steel
Suction tube	Carbon steel
Air inlet connection	bsp F 1/2"
Fluid outlet connection	bsp F 1.1/2"
Max. air consumption 8 bar	m³/min 1,6
Noise level	dB 80
Air max. feed pressure	bar 8

Suitable for drums or tanks

Packing	N° - m³ 1 - 0,20
Weight	kg 45
Dimensions (A - B - C)	cm 36 - 62,5 - 16,2

- A A** 8 bar 116 psi
- B B** 6 bar 87 psi
- C C** 4 bar 58 psi

Ratio 4:1
Flow rate **110 l/min**

Ratio 6:1
Flow rate **80 l/min**

Ratio 5:1
Flow rate **90 l/min**

Ratio 8:1
Flow rate **65 l/min**

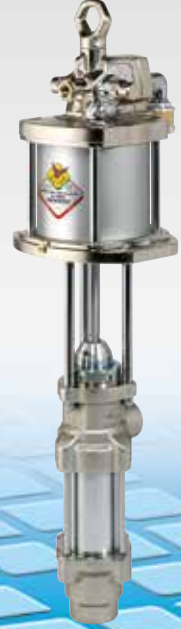

series 1500

series 1500

series 1800

series 1800

divorced

divorced

divorced

divorced

150D/41

150D/61

180D/51

180D/81

150DV/61

180DV/81

Oils, lubricants
and similar
Carbon steel
Carbon steel

Oils, lubricants
and similar
Carbon steel
Carbon steel

Oils, lubricants
and similar
Carbon steel
Carbon steel

Oils, lubricants
and similar
Carbon steel
Carbon steel

F 1/2"
F 1.1/2"

F 1/2"
F 1.1/2"

F 1/2"
F 1.1/2"

F 1/2"
F 1.1/2"

3,4
80
8

3,4
80
8

3,4
80
8

4,2
80
8

4,2
80
8

4,2
80
8

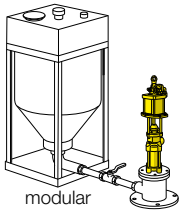

1 - 0,20

63

43 - 62,5 - 17,7

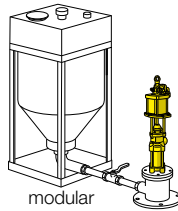

1 - 0,20

53

43 - 62,5 - 16,2

1 - 0,20

53

43 - 62,5 - 16,2

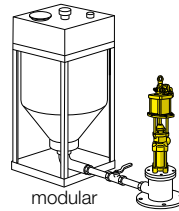

1 - 0,20

65

43 - 62,5 - 17,7

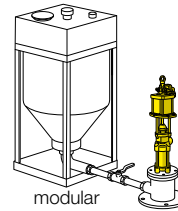

1 - 0,20

56

43 - 62,5 - 16,2

1 - 0,20

56

43 - 62,5 - 16,2

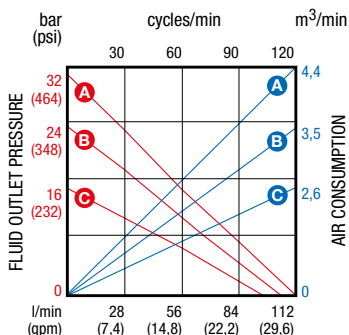

KIND OF FLUID: SAE30 oil (ISO VG 100) - 20 °C

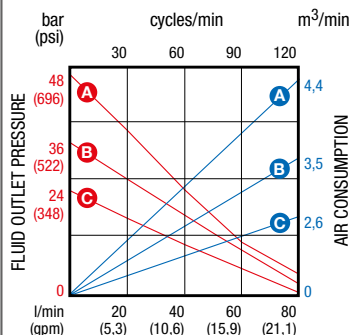

KIND OF FLUID: SAE30 oil (ISO VG 100) - 20 °C

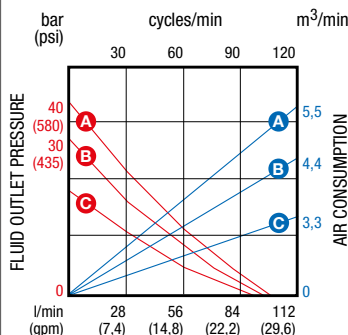

KIND OF FLUID: SAE30 oil (ISO VG 100) - 20 °C

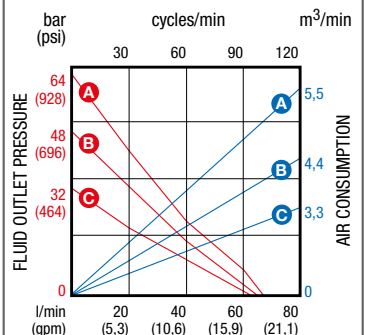

KIND OF FLUID: SAE30 oil (ISO VG 100) - 20 °C



Air-operated INDUSTRIAL PUMPS

grease

Ratio **45:1**
Flow rate **4400 g/min**



Series 900 - 1200 industrial air-operated pumps for medium-long distance distribution. Suitable for the transfer of medium-high viscosity oils and greases. The high quality of the components ensures lasting and reliable operation even in extreme conditions whereas the double action guarantees the delivery of a continuous and constant flow. Particularly effective in systems equipped with several dispensing points.

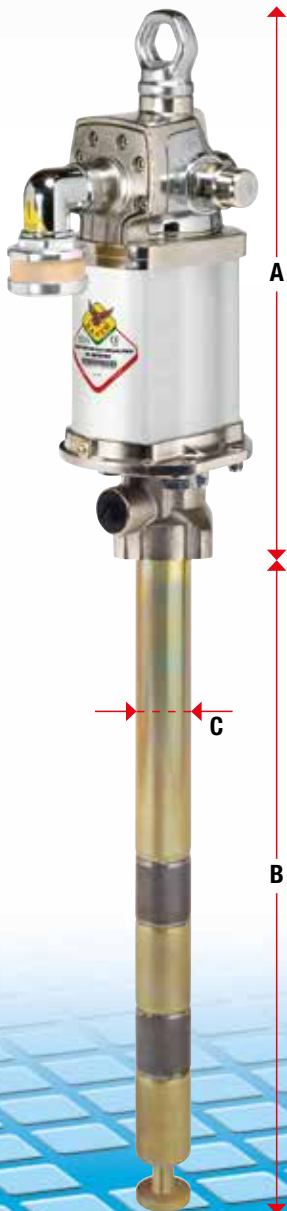

series **900**

flanged

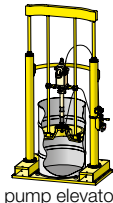
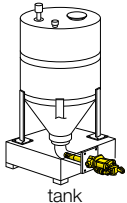

Article with seals in	PU	90FSP/451	90F/451	92F/451	91F/451
Compatible fluids		High viscosity oils and greases			
Suction tube upper body		Carbon steel			
Suction tube		Carbon steel			
Air inlet connection	bsp	F 1/2"	F 1/2"	F 1/2"	F 1/2"
Fluid outlet connection	bsp	F 1/2"	F 1/2"	F 1/2"	F 1/2"
Max. air consumption 8 bar	m ³ /min	1,6	1,6	1,6	1,6
Noise level	dB	80	80	80	80
Air max. feed pressure	bar	8	8	8	8
Suitable for drums or tanks		 pump elevator	 tank	 suitable for drums 50-60 kg	 suitable for drums 180-220 kg
Packing	N° - m ³	1 - 0,085	1 - 0,045	1 - 0,070	1 - 0,070
Weight	kg	16	16	18	19
Dimensions (A - B - C)	cm	44,5 - 50 - 4,5	44,5 - 50 - 4,5	44,5 - 74 - 4,5	44,5 - 94 - 4,5

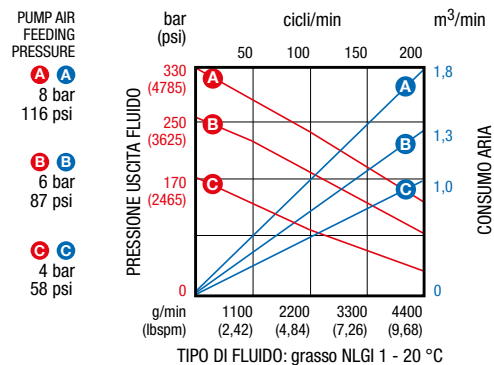

Ratio 70:1
Flow rate **3000 g/min**

Ratio 75:1
Flow rate **4400 g/min**

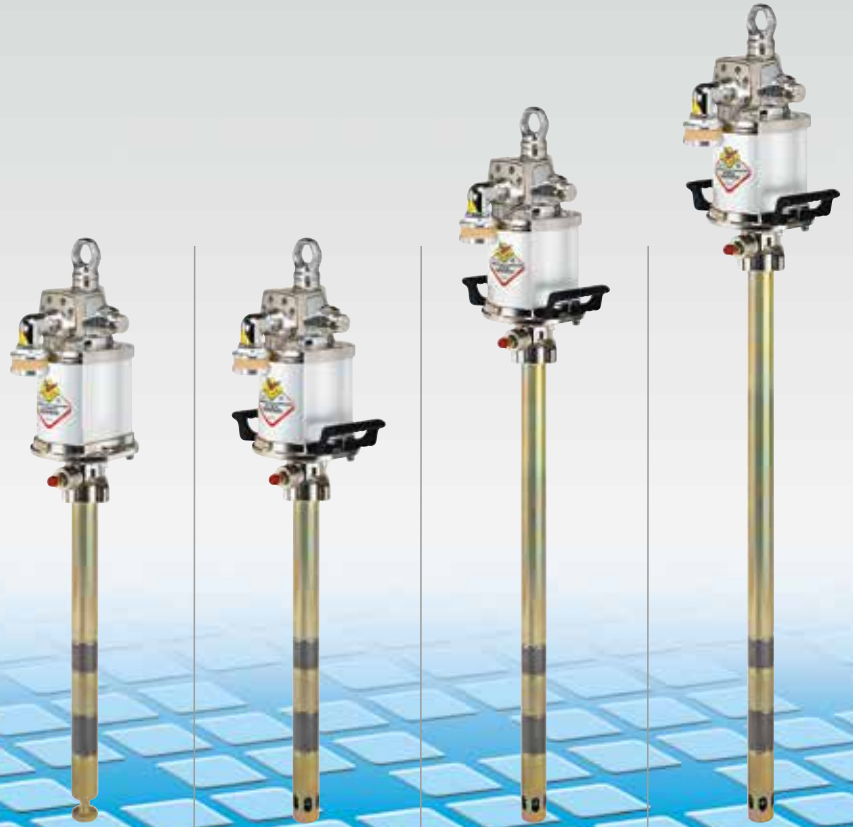

series 900

series 1200

integral

flanged

92C/701

91C/701

115FSP/751

115F/751

117F/751

116F/751

High viscosity oils and greases

High viscosity oils and greases

Aluminium
Carbon steel

Carbon steel
Carbon steel

F 1/2"

F 1/2"

F 1/2"

F 1/2"

F 1/2"

F 1/2"

F 1/2"

F 1/2"

F 1/2"

F 1/2"

F 1/2"

F 1/2"

1,6

1,6

2,8

2,8

2,8

2,8

80

80

80

80

80

80

8

8

8

8

8

8



suitable for drums
50-60 kg

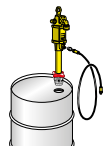

suitable for drums
180-220 kg

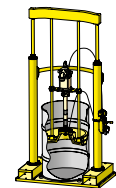

pump elevator

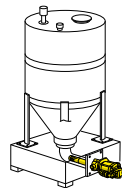

tank

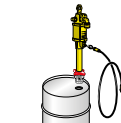

suitable for drums
50-60 kg

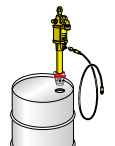

suitable for drums
180-220 kg

1 - 0,070

1 - 0,070

1 - 0,045

1 - 0,045

1 - 0,070

1 - 0,070

18

19

18

18

20

21

43 - 74 - 4,5

43 - 94 - 4,5

44,5 - 50 - 4,5

44,5 - 50 - 4,5

44,5 - 74 - 4,5

44,5 - 94 - 4,5

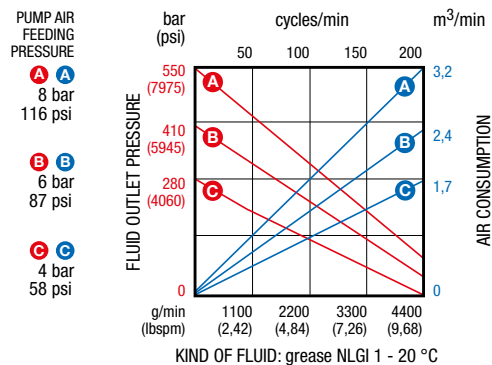
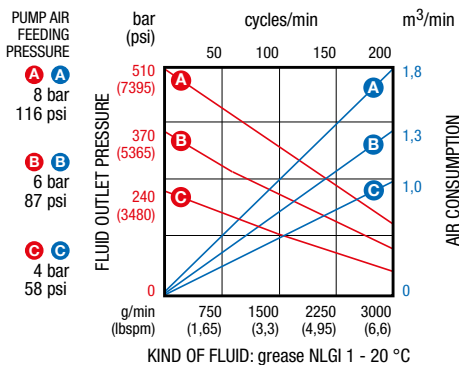



Air-operated INDUSTRIAL PUMPS

grease

Ratio **40:1**
Flow rate **10000 g/min**

Series 1200 and 1500 industrial air-operated pumps for medium-long distance distribution.

Suitable for transferring oils, lubricants and allied products, they guarantee high performance in capacity (l/min) and operating pressure.

The high quality of the components ensures lasting and reliable operation even in extreme conditions.

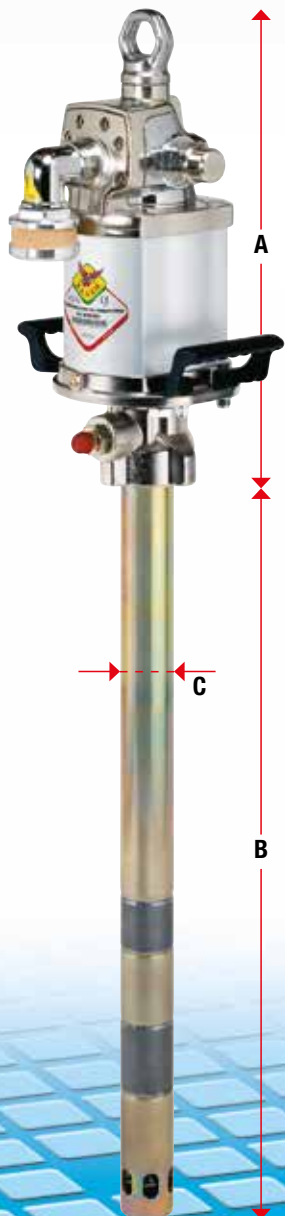

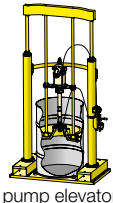
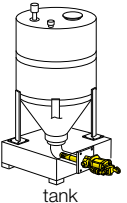
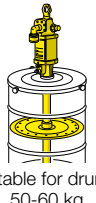
Article with seals in	PU	118FSP/401	118F/401	115F/401
Compatible fluids		High viscosity oils and greases		
Suction tube upper body		Carbon steel		
Suction tube		Carbon steel		
Air inlet connection	bsp	F 1/2"	F 1/2"	F 1/2"
Fluid outlet connection	bsp	F 1/2"	F 1/2"	F 1/2"
Max. air consumption 8 bar	m ³ /min	2,8	2,8	2,8
Noise level	dB	80	80	80
Air max. feed pressure	bar	8	8	8
Suitable for drums or tanks		 pump elevator	 tank	 suitable for drums 50-60 kg
Packing	N° - m ³	1 - 0,090	1 - 0,090	1 - 0,090
Weight	kg	21	21	23
Dimensions (A - B - C)	cm	44,5 - 60 - 5,08	44,5 - 60 - 5,08	44,5 - 74 - 5,08

Art. 10/09
Adaptor for integral and flanged pumps series 900 and 1200, for application with other brackets

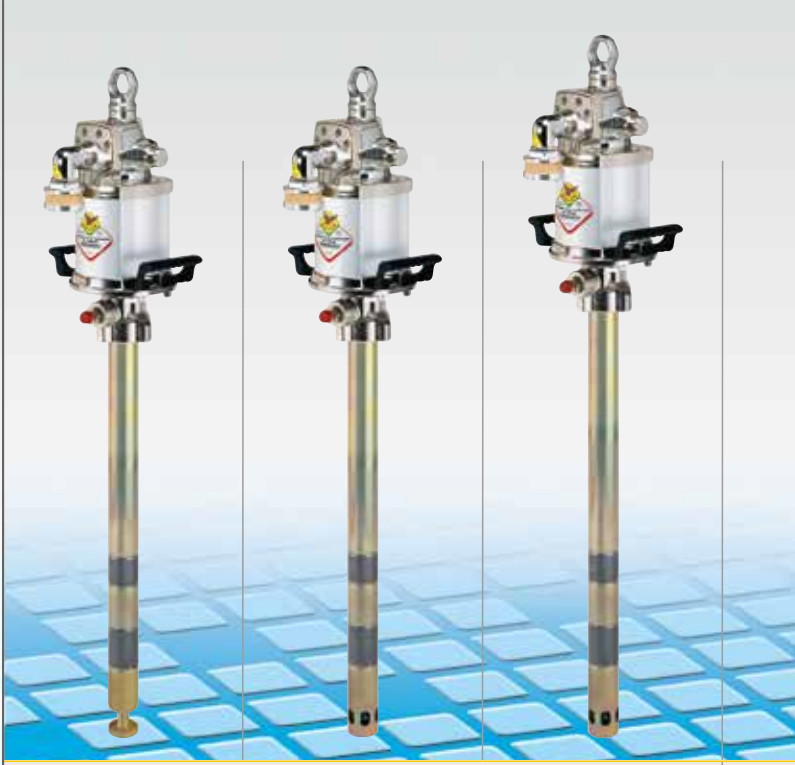
series **1200**

flanged

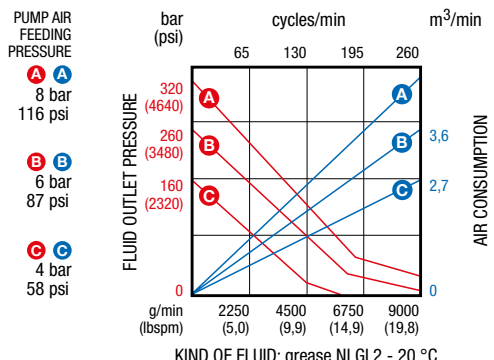

Ratio 70:1
Flow rate 7000 g/min



series 1200

series 1500

flanged

flanged

117F/401

116F/401

153FSP/701

153F/701

150F/701

152F/701

151F/701

High viscosity oils and greases
 Carbon steel
 Carbon steel

High viscosity oils and greases
 Carbon steel
 Carbon steel

F 1/2"

F 1/2"

F 1/2"

F 1/2"

F 1/2"

F 1/2"

F 1/2"

F 1/2"

F 1/2"

F 1/2"

F 1/2"

F 1/2"

F 1/2"

F 1/2"

2,8

2,8

4,3

4,3

4,3

4,3

4,3

80

80

80

80

80

80

80

8

8

8

8

8

8

8

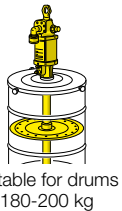
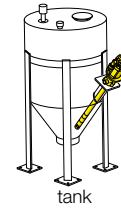
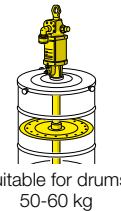
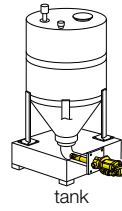
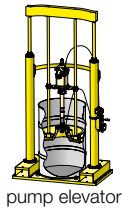
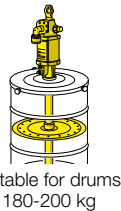
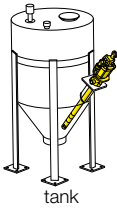

1 - 0,090

1 - 0,090

1 - 0,20

1 - 0,20

1 - 0,20

1 - 0,20

1 - 0,20

24

25

29

29

31

32

33

44,5 - 86 - 5,08

44,5 - 94 - 5,08

50 - 60 - 5,08

50 - 60 - 5,08

50 - 74 - 5,08

50 - 86 - 5,08

50 - 94 - 5,08

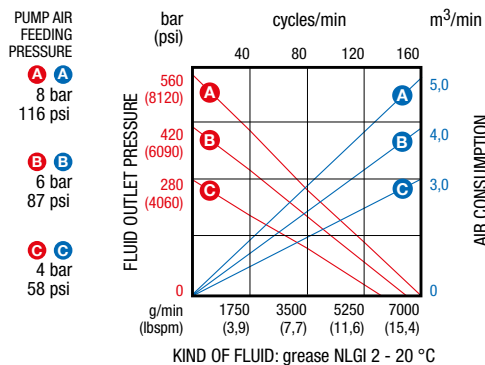
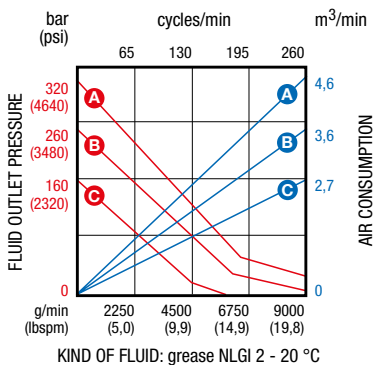



Air-operated INDUSTRIAL PUMPS

industrial fluids

Series 900 and 1200 divorced industrial air-operated pumps for medium-long distance distribution.

The divorced version, with Teflon® seals, can also be used for the transfer of industrial and chemical fluids. The high quality of the components ensures lasting and reliable operation even in extreme conditions.



Article with seals in	Teflon®
Compatible fluids	Chemical and industrial fluids
Suction tube upper body	Carbon steel
Suction tube	Carbon steel
Air inlet connection	bsp F 1/2"
Fluid outlet connection	bsp F 3/4"
Max. air consumption 8 bar	m ³ /min 1,6
Noise level	dB 80
Air max. feed pressure	bar 8

Suitable for drums or tanks

Packing	N° - m ³
Weight	kg 14,5
Dimensions (A - B - C)	cm 36 - 48 - 6,2

PUMP AIR FEEDING PRESSURE	
A	8 bar / 116 psi
B	6 bar / 87 psi
C	4 bar / 58 psi

Ratio **5:1**
Flow rate **45 l/min**

Ratio **7:1**
Flow rate **30 l/min**



series 900	series 900
divorced	divorced
90D/51	90D/71
Compatible fluids	Chemical and industrial fluids
Suction tube upper body	Carbon steel
Suction tube	Carbon steel
Air inlet connection	F 1/2"
Fluid outlet connection	F 3/4"
Max. air consumption 8 bar	m ³ /min 1,6
Noise level	dB 80
Air max. feed pressure	bar 8
modular	modular
Packing	N° - m ³
Weight	kg 13,5
Dimensions (A - B - C)	cm 36 - 48 - 5,3

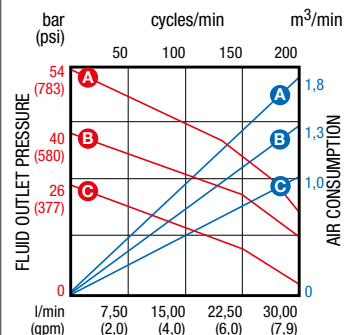
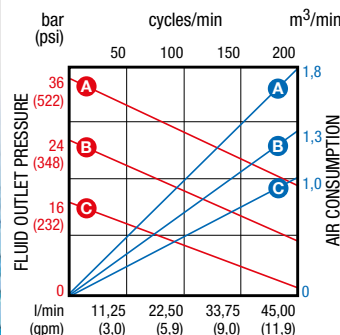

Ratio 11:1
Flow rate **30 l/min**

Ratio 9:1
Flow rate **45 l/min**

Ratio 12:1
Flow rate **30 l/min**

Ratio 18:1
Flow rate **23 l/min**



series 900	series 1200	series 1200	series 1200
divorced	divorced	divorced	divorced
90D/111	115D/91	115D/121	115D/181
Chemical and industrial fluids	Chemical and industrial fluids	Chemical and industrial fluids	Chemical and industrial fluids
Carbon steel	Carbon steel	Carbon steel	Carbon steel
Carbon steel	Carbon steel	Carbon steel	Carbon steel
F 1/2"	F 1/2"	F 1/2"	F 1/2"
F 3/4"	F 3/4"	F 3/4"	F 3/4"
1,7	2,8	2,8	2,8
80	80	80	80
8	8	8	8
modular	modular	modular	modular
1 - 0,045	1 - 0,045	1 - 0,045	1 - 0,045
13	15,5	14,5	14
36 - 48 - 4,5	36 - 48 - 6,2	36 - 48 - 5,3	36 - 48 - 4,5

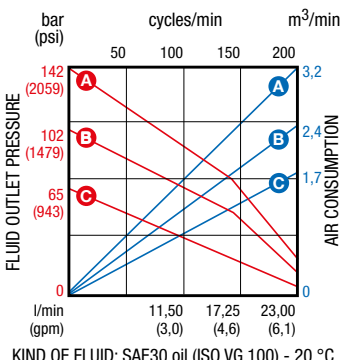
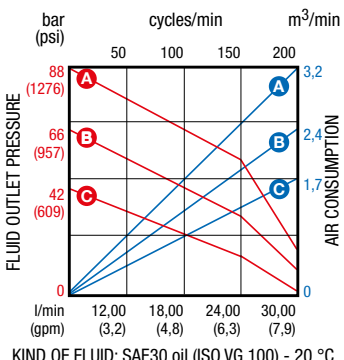
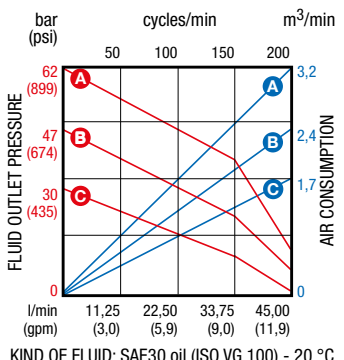
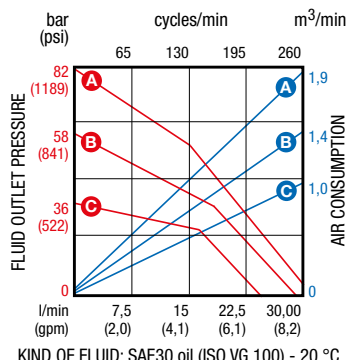



Stainless steel AISI 304 pumps for TRANSFER

Ratio **1:1**
Flow rate **30 l/min**

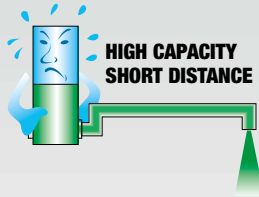

Stainless steel AISI 304 air-operated pumps for short-medium distance transfer. Ideal for transferring low-medium viscosity fluids such as: antifreeze liquid, windshield washing liquid and chemical products.

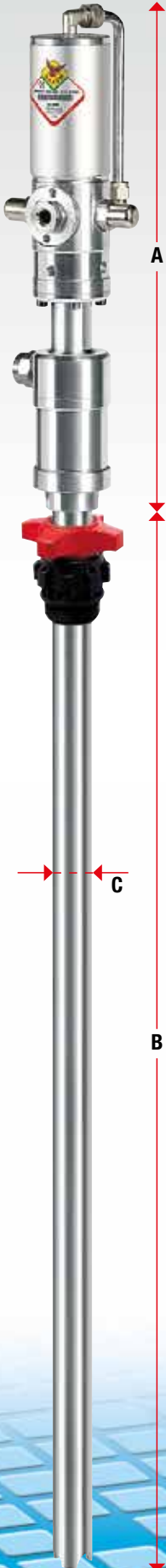

series **600 INOX**

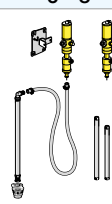
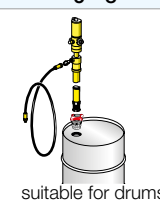
Article with seals in Viton®	divorced	
	33360	33396
Compatible fluids	Suitable for antifreeze and windshield washing liquid	
Suction tube upper body	Stainless steel AISI 304	
Suction tube	Stainless steel AISI 304	
Air inlet connection	F 1/4" G	F 1/4" G
Fluid outlet connection	F 1/2" G	F 1/2" G
Max. air consumption 8 bar	0,37	0,37
Noise level	81	81
Air max. feed pressure	6 - 8	6 - 8
Suitable for drums or tanks	 modular	 suitable for drums 180-220 kg
Packing	1 - 0,010	1 - 0,020
Weight	5,3	7,4
Dimensions (A - B - C)	41 - 0 - 0	41 - 94 - 3,4

Art. 33445
Gun for antifreeze and windshield liquid with stainless steel rigid terminal

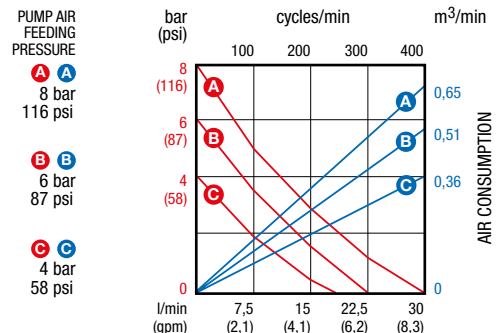

KIND OF FLUID: windshield washing fluid with water



Air-operated INDUSTRIAL PUMPS S/STEEL AISI 304

industrial fluids

Series 900 - 1200 divorced stainless steel AISI 304 industrial air-operated pumps for medium-long distance distribution. They are suitable to transfer aggressive fluids compatible with the wet parts of the pump (stainless steel and Teflon®). The high quality of the components ensures lasting and reliable operation even in extreme conditions.



Article with seals in	Teflon®	
	95D/61	120D/91
	94D/61	
Compatible fluids	Chemical and industrial fluids	
Suction tube upper body	Stainless steel AISI 304	
Suction tube	Stainless steel AISI 304	
Air inlet connection	bsp F 1/2"	bsp F 1/2"
Fluid inlet connection	bsp F 1.1/4"	bsp F 1"
Fluid outlet connection	bsp F 3/4"	bsp F 3/4"
Max. air consumption 8 bar	m ³ /min 1,6	m ³ /min 1,6
Noise level	dB 80	dB 80
Air max. feed pressure	bar 8	bar 8
Suitable for drums or tanks		
Packing	N° - m ³ 1 - 0,045	N° - m ³ 1 - 0,045
Weight	kg 14,5	kg 14,5
Dimensions (A - B - C)	cm 36 - 48 - 6,0	cm 36 - 48 - 6,0

PUMP AIR FEEDING PRESSURE

A 8 bar
116 psi

B 6 bar
87 psi

C 4 bar
58 psi

Ratio **6:1**
Flow rate **42 l/min**

Ratio **9:1**
Flow rate **42 l/min**



series 900	series 1200
divorced	divorced
95D/61	120D/91
94D/61	
Compatible fluids	Chemical and industrial fluids
Suction tube upper body	Stainless steel AISI 304
Suction tube	Stainless steel AISI 304
Air inlet connection	bsp F 1/2"
Fluid inlet connection	bsp F 1"
Fluid outlet connection	bsp F 3/4"
Max. air consumption 8 bar	m ³ /min 2,8
Noise level	dB 80
Air max. feed pressure	bar 8
Suitable for drums or tanks	
Packing	N° - m ³ 1 - 0,045
Weight	kg 15,5
Dimensions (A - B - C)	cm 36 - 48 - 6,0

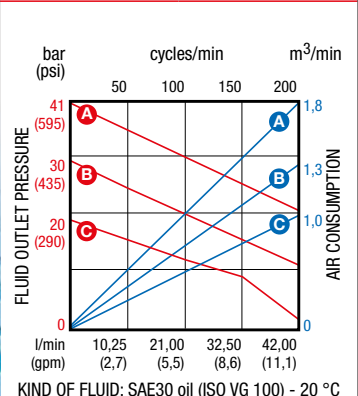

series 900	series 1200
divorced	divorced
95D/61	120D/91
94D/61	
Compatible fluids	Chemical and industrial fluids
Suction tube upper body	Stainless steel AISI 304
Suction tube	Stainless steel AISI 304
Air inlet connection	bsp F 1/2"
Fluid inlet connection	bsp F 1"
Fluid outlet connection	bsp F 3/4"
Max. air consumption 8 bar	m ³ /min 1,6
Noise level	dB 80
Air max. feed pressure	bar 8
Suitable for drums or tanks	
Packing	N° - m ³ 1 - 0,045
Weight	kg 14,5
Dimensions (A - B - C)	cm 36 - 48 - 6,0

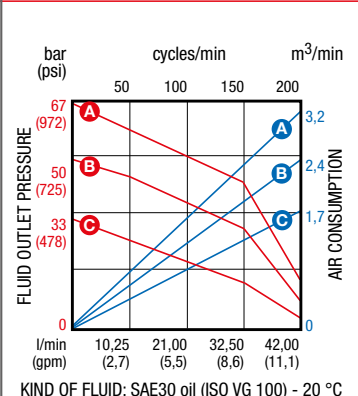



Accessories for industrial pumps

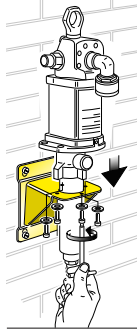
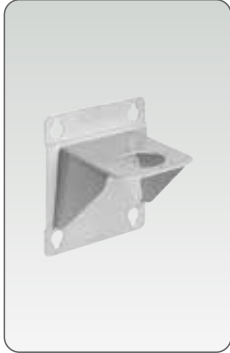

Art. 10/10
Wall bracket in painted steel for wall-mounting of integral and flanged industrial pumps, series 900 and 1200

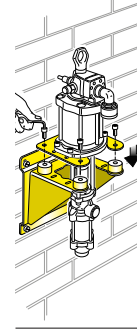

Art. 10/18
Wall bracket in painted steel with dampers for wall-mounting of divorced industrial pumps, with suction tube \varnothing 100 mm, series 900 and 1200

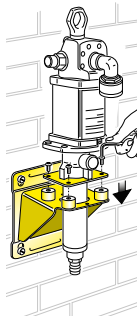

Art. 10/11
Wall bracket in painted steel with dampers for wall-mounting of integral and flanged industrial pumps, series 900 and 1200

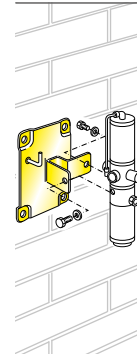

Art. 33115
Wall bracket in steel for wall-mounting of transfer pumps, series 600 and 650

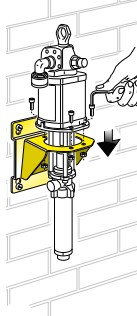

Art. 10/12
Wall bracket in painted steel for wall-mounting of divorced industrial pumps, series 900 and 1200

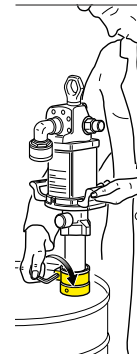
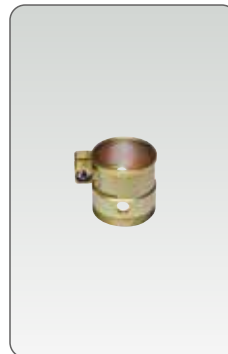

Art. 10/14
Bung adaptor, for industrial pumps with suction tube, \varnothing 45 mm series 900 and 1200

Art. 10/15
Bung adaptor, for industrial pumps with suction tube, \varnothing 53 mm series 900 and 1200

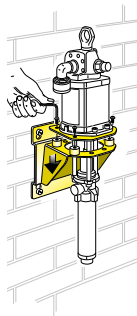

Art. 10/13
Wall bracket in painted steel with dampers for wall-mounting of divorced industrial pumps, series 900 and 1200

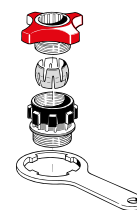
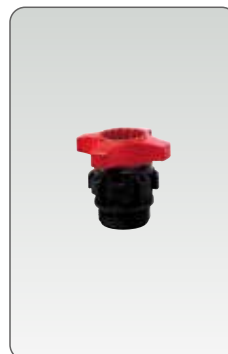

Art. 33434
Bung adaptor \varnothing 34 mm, with double body for pumps with suction tube, series 600

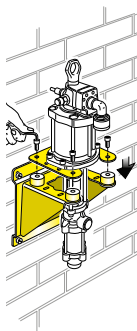

Art. 10/17
Wall bracket in painted steel with dampers for wall-mounting of flanged industrial pumps, series 1500 and 1800

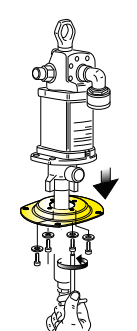
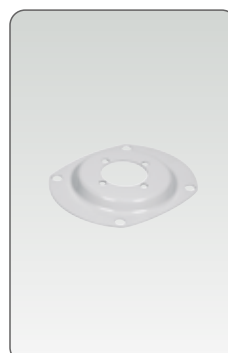

Art. 10/09
Adaptor for integral and flanged pumps series 900 e 1200, for application with other brackets



Accessories for industrial pumps

Union \varnothing 45 mm



Drum cover for pumps with suction tube \varnothing 45

Art. 10/50 Drum cover \varnothing 600 mm for drums 180 - 220 kg
(drums external \varnothing 550 - 600 mm)

Art. 10/51 Drum cover \varnothing 420 mm for drums 50 - 60 kg
(drums external \varnothing 370 - 420 mm)

Art. 10/52 Drum cover \varnothing 385 mm for drums 30 - 50 kg
(drums external \varnothing 340 - 385 mm)



Follower plate for pumps S. 900 - 1200 with suction tube \varnothing 45

Art. 10/60 Follower plate \varnothing 585 mm for drums 180 - 220 kg
(drums internal \varnothing 540 - 580 mm)

Art. 10/61 Follower plate \varnothing 400 mm for drums 50 - 60 kg
(drums internal \varnothing 360 - 400 mm)

Art. 10/62 Follower plate \varnothing 370 mm for drums 30 - 50 kg
(drums internal \varnothing 335 - 360 mm)



Union \varnothing 50,8 mm



Drum cover for pumps with suction tube \varnothing 50,8

Art. 10/55 Drum cover \varnothing 600 mm for drums 180 - 220 kg
(drums external \varnothing 550 - 600 mm)

Art. 10/56 Drum cover \varnothing 420 mm for drums 50 - 60 kg
(drums external \varnothing 370 - 420 mm)

Art. 10/57 Drum cover \varnothing 385 mm for drums 30 - 50 kg
(drums external \varnothing 340 - 385 mm)

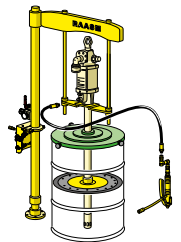

Follower plate for pumps S. 1200 - 1500 with suction tube \varnothing 50,8

Art. 10/65 Follower plate \varnothing 585 mm for drums 180 - 220 kg
(drums internal \varnothing 540 - 580 mm)

Art. 10/66 Follower plate \varnothing 400 mm for drums 50 - 60 kg
(drums internal \varnothing 360 - 400 mm)

Art. 10/67 Follower plate \varnothing 370 mm for drums 30 - 50 kg
(drums internal \varnothing 335 - 360 mm)



Union 2" F



Drum cover with threaded bushing 2" F

Art. 65160 Follower plate \varnothing 600 mm for drums 180 - 220 kg
(drums external \varnothing 550 - 600 mm)
suitable to fit pump bung adaptor

Art. 65142 Follower plate \varnothing 420 mm for drums 50 - 60 kg
(drums external \varnothing 370 - 420 mm)
suitable to fit pump bung adaptor

Art. 65138 Follower plate \varnothing 385 mm for drums 30 - 50 kg
(drums external \varnothing 340 - 385 mm)
suitable to fit pump bung adaptor

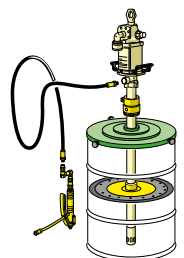



Air-operated pump elevator

1 column

The Pump elevators are available in single column (with or without basement) or twin column version. It is raised by compressed air, via the side mounted 3-way valve allowing to change the drum easily and quickly. A special version of the twin columns elevator is equipped with 2 rods which connected to a special follower plate (available on request) may push it downward making easier suction of the fluid and increasing the performance of the pump. They are available for 180-220 kg drums.

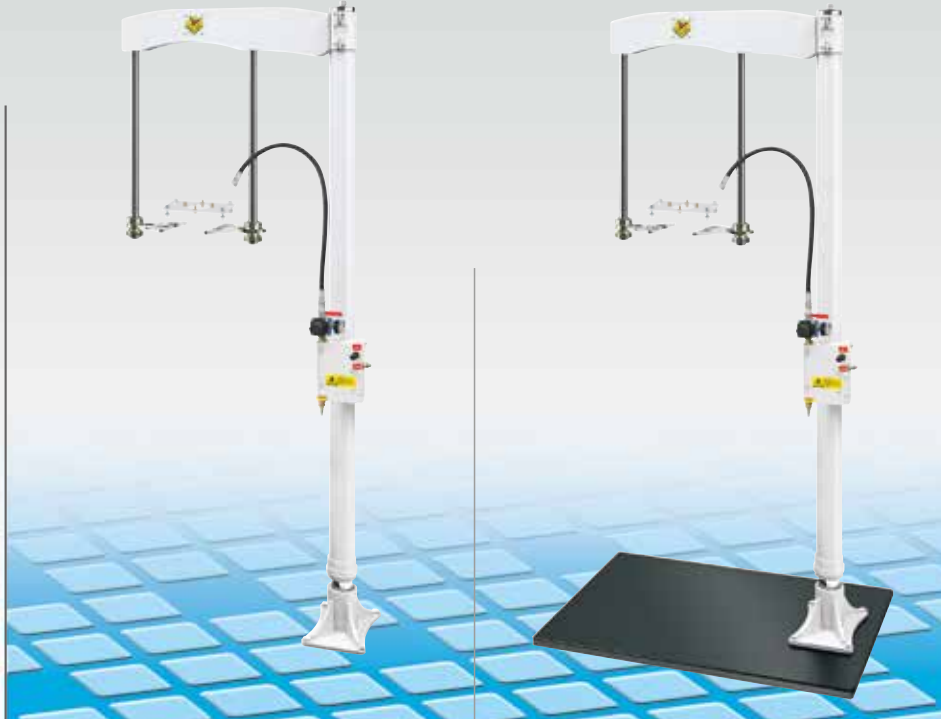

Article	10/81	10/80
Column	1	1
Suitable for drums	180 - 220	180 - 220
Working temperature	+ 2 °C + 40 °C	+ 2 °C + 40 °C
Pressione max	8	8
Usable pumps	S. 600 - 700 grease pump - 900 - 1200 - 1500 - 1800	
Noise level	negligible (< 70)	
Pushing force upwards at:	* 4 bar 113 kg - 6 bar 170 kg - 8 bar 226 kg	
Pushing force downwards at:	-	
Packing	1 - 0,679	1 - 1,165
Gross weight	75	97
Height max/min (A - B)	271,5 - 171,5	275 - 175
Dimensions (C - D)	14 - 25,5	86,6 - 63

Nota: *theoretical values, the coefficients of friction are not calculated.

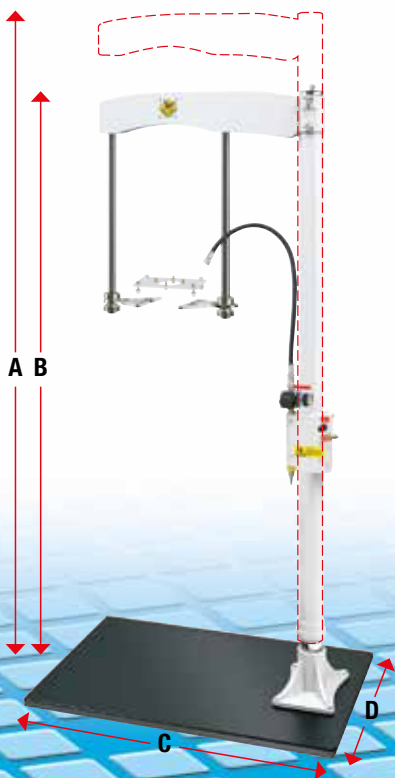

STANDARD BRACKETS

All the elevators are equipped with 2 standard brackets (A - B) suitable for mounting all our industrial pumps.

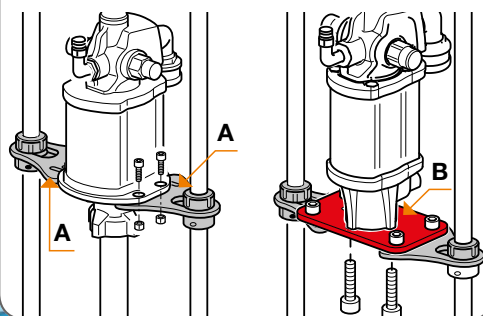

BRACKETS ON REQUEST

KR1102: Special support suitable to mount pump with ø 30 mm suction tube.

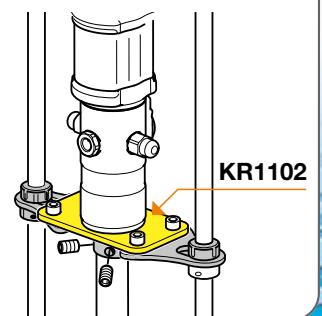

2 column



10/82

2

180 - 220
+ 2 °C + 40 °C

8

S. 600 - 700 grease pump - 900 - 1200 - 1500 - 1800
negligible (< 70)

*

4 bar 226 kg - 6 bar 339 kg - 8 bar 452 kg

-

1 - 1,406

128

275 - 175

108,6 - 63

2 column + fluid press



10/85

2

180 - 220
+ 2 °C + 40 °C

8

S. 600 - 700 grease pump - 900 - 1200 - 1500 - 1800
negligible (< 70)

*

4 bar 509 kg - 6 bar 763 kg - 8 bar 1017 kg

**

4 bar 432 kg - 6 bar 648 kg - 8 bar 864 kg

1 - 1,840

187

280 - 180

108,6 - 63

Nota: **theoretical figures: friction has not been considered. Furthermore depression's force created by the pump during suction (+2100 kg) must be added to the listed figures.

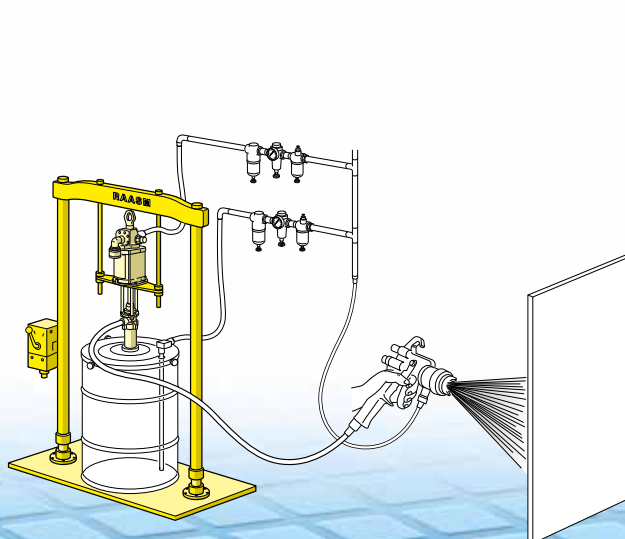

Fluid distribution system (for paints, lubricants, protective liquids, etc.) fed by pump mounted on drum in fixed station and delivery with spray gun.

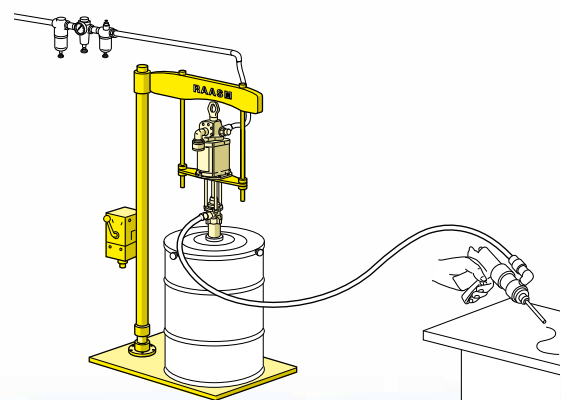

Automated system for the delivery of preselected quantities of fluids (inks, paints, greases, etc.), fed by pump mounted on drum, with twin column ram



Air-operated twin column ram hoist

low pressure/high flow rate

Air-operated twin column ram hoist with industrial pump. It is raised and lowered by compressed air, via the side mounted 3-way valve. Essential when pumping high viscosity and heavy fluids since ram pushes down the follower plate helping pump working. It is suitable for 180- 220 kg drums.

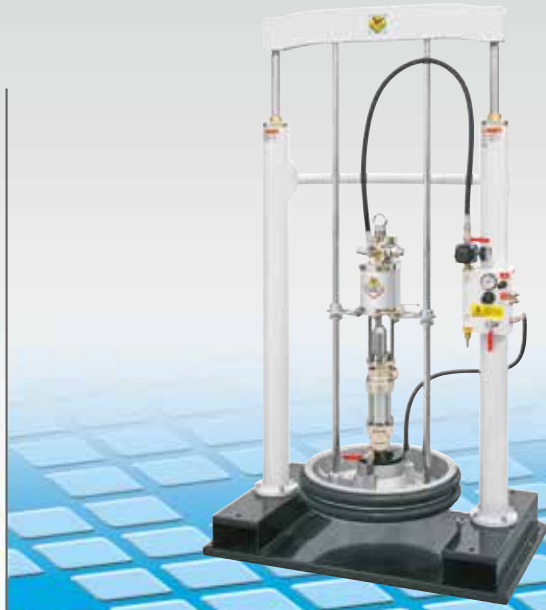

Article with follower plate with pump seals	NBR PU	10/1561P1N	10/1881P1N
Ratio		6:1	8:1
Flow rate		80 l/min	65 l/min
Pump	Art.	150D/61	180D/81
Suction tube		F 2" G	F 2" G
Twin column ram	Art.	10/85	10/85
Follower plate	Art.	11/60	11/60
Adaptors for follower plate	Art.	21/62	21/62
Pump connection hose	Art.	996.3015	996.3015
Follower plate connection hose	Art.	995.301	995.301
Suitable for drums	kg	200	200
Packing	N° - m ³	1 - 1,80	1 - 1,80
Weight	kg	263	266
Height max/min (A - B)	cm	280 - 180	280 - 180
Dimensions (C - D)	cm	108,6 - 63	108,6 - 63

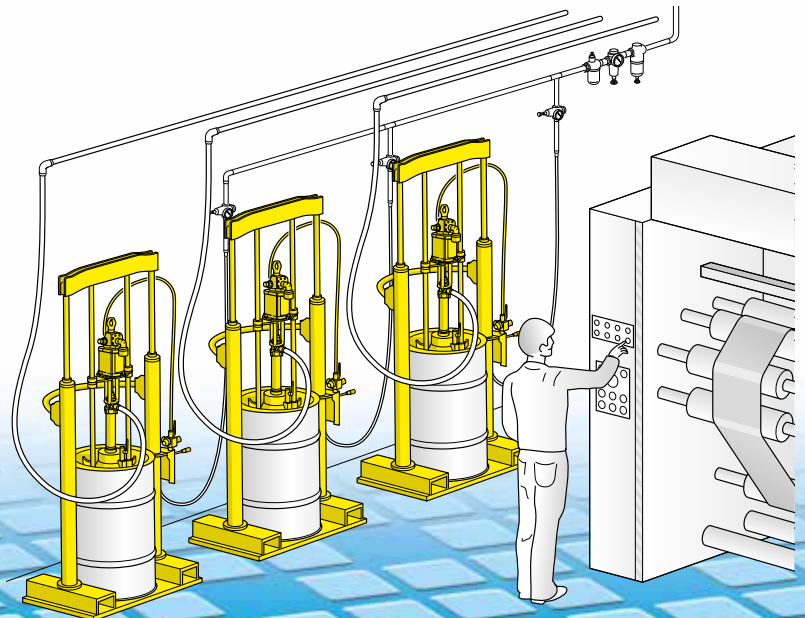
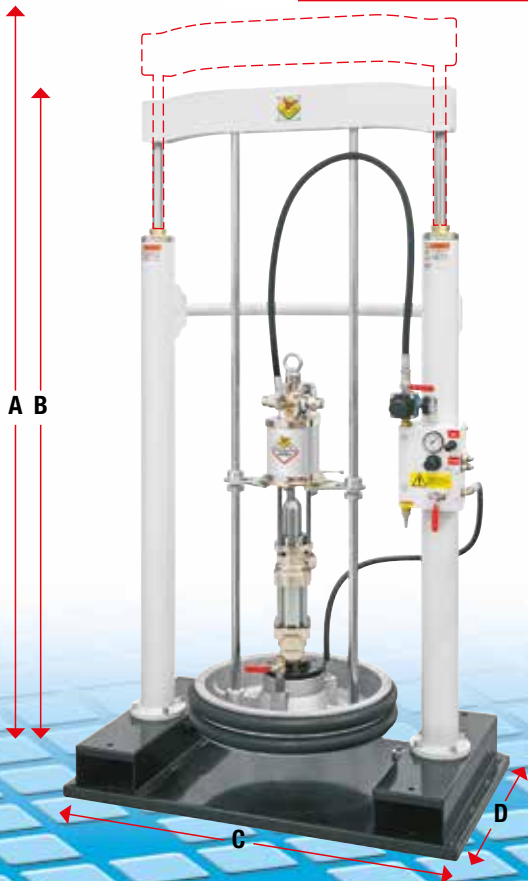

medium pressure/medium flow rate

high pressure/low flow rate



10/09111P1N	10/12181P1N	10/12401P1N	10/09451P1N	10/12751P1N	10/15701P1N
11:1	18:1	40:1	45:1	75:1	70:1
30 l/min	23 l/min	10 kg/min	4,4 kg/min	4,4 kg/min	7 kg/min
90F/111	115F/181	118FSP/401	90FSP/451	115FSP/751	153FSP/701
ø 45	ø 45	ø 50,8	ø 45	ø 45	ø 50,8
10/85	10/85	10/85	10/85	10/85	10/85
11/60	11/60	11/60	11/60	11/60	11/60
21/64	21/64	21/65	21/64	21/64	21/65
996.3015	996.3015	996.3015	996.3015	996.3015	996.3015
995.301	995.301	995.301	995.301	995.301	995.301
200	200	200	200	200	200
1 - 1,80	1 - 1,80	1 - 1,80	1 - 1,80	1 - 1,80	1 - 1,80
225	226	231	228	230	238
280 - 180	280 - 180	280 - 180	280 - 180	280 - 180	280 - 180
108,6 - 63	108,6 - 63	108,6 - 63	108,6 - 63	108,6 - 63	108,6 - 63

Technical features

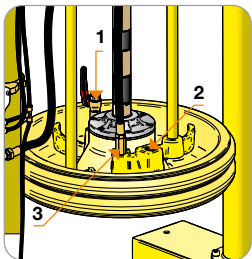

- 1 Ball cock for air bleeding during followerplate setting on new drum
- 2 Optional connection to pump outlet for pump starting and air bleeding when using a new drum
- 3 Air hose connection for follower plate lifting

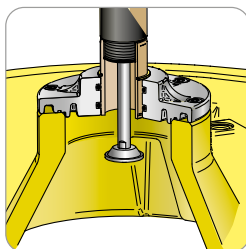

Conical follower plate and bottom pumping group

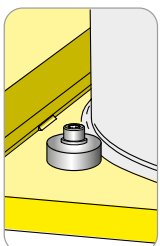

References to centre the drum

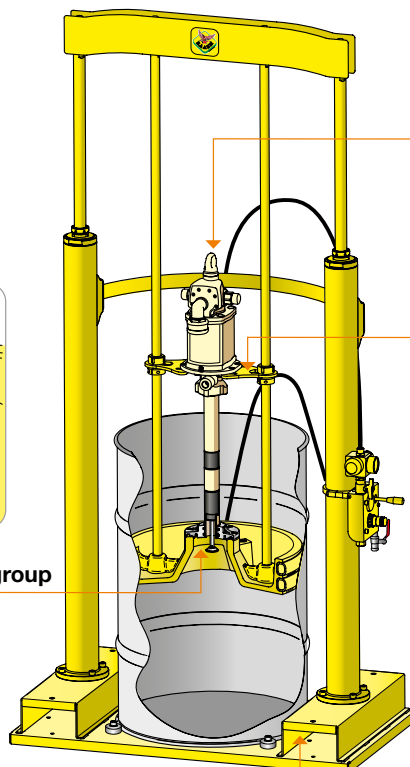

Pump feeding air inlet

Support with pump positioning clamps

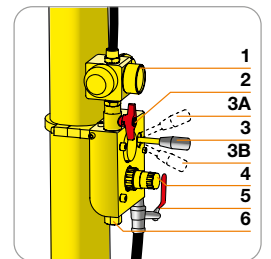

- 1 Pressure regulator with manometer for pump air feeding
- 2 Pump air feeding ball cock
- 3A Follower plate and pump lifting position
- 3 Off position
- 3B Follower plate descent position
- 4 Pressure regulator with manometer for twin column ram air feeding
- 5 Ball cock to put air under the follower plate for pump lifting
- 6 Air inlet connection





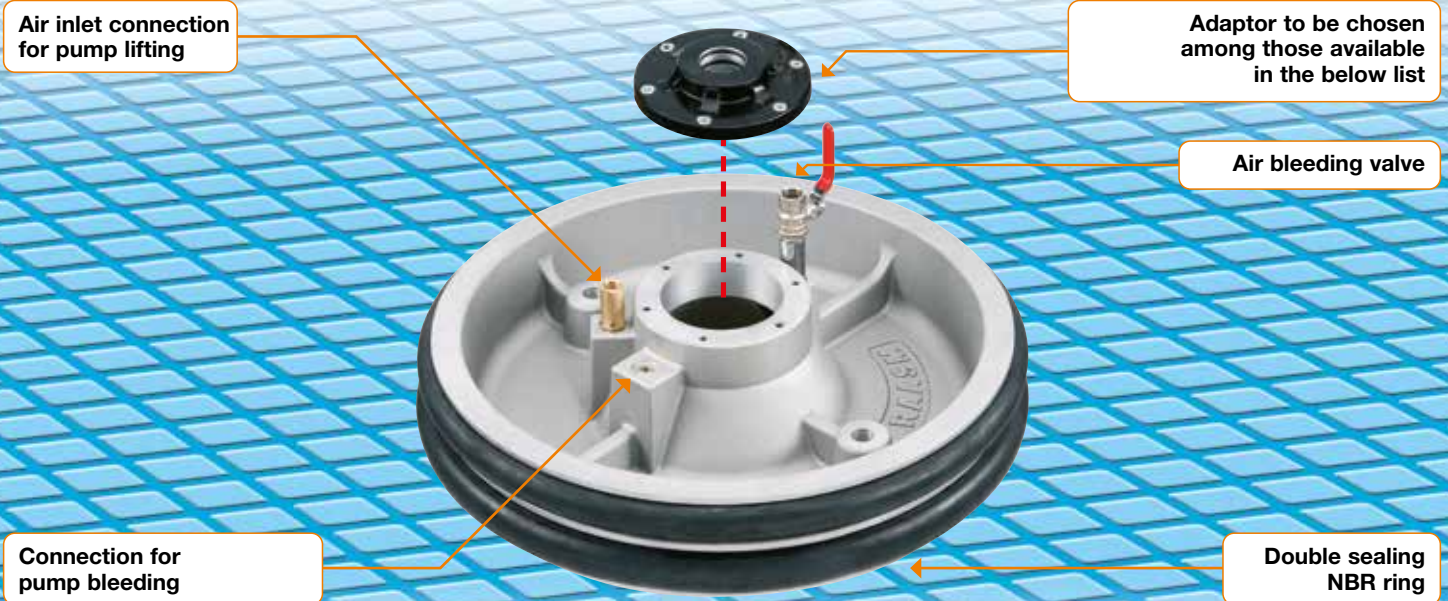

Technical characteristics

Follower plate ø 585 mm with double sealing NBR ring, to be used with air operated twin column ram for drums 180 - 220 kg, for grease or high viscosity fluid.

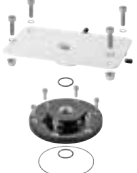

The follower plate can be used with different kind of pumps thanks to special adaptors shown in the below list and available on request.

Article		Description
Art. 11/60		Follower plate ø 585 mm with double o-ring in NBR
Art. 21/61		Adaptor suitable for pumps with F 1" G suction tube
Art. 21/62		Adaptor suitable for pumps with F 2" G suction tube
Art. 21/64		Adaptor suitable for pumps with ø 45 mm suction tube
Art. 21/65		Adaptor suitable for pumps with ø 50,8 mm suction tube
Art. 21/63		Adaptor + Support (KR1102) suitable for pumps with ø 30 mm suction tube Grease pumps Series 600 - 700



Twin column ram: PERSONALIZED KIT

In order to satisfy any particular need it is possible to create one's personalized kit choosing pump, follower plate, adaptors and support. We suggest you to look at the information explained in the following pattern.

1 Twin column ram



Art. 10/85

2 Pumps

Choose the industrial pump with technical features (pressure ratio, flow rate, etc.) suitable for one's needs.

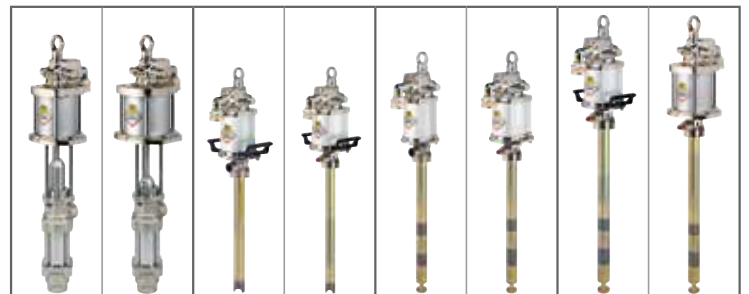

Article	150D/61	180D/81	90F/111	115F/181	90FSP/451	115FSP/751	118FSP/401	153FSP/701
Series	1500	1800	900	1200	900	1200	1200	1500
Ratio	6:1	8:1	11:1	18:1	45:1	75:1	40:1	70:1
Flow rate	80 l/min	65 l/min	30 l/min	23 l/min	4400 g/min	4400 g/min	10000 g/min	7000 g/min
Seals	polyurethane	polyurethane	polyurethane	polyurethane	polyurethane	polyurethane	polyurethane	polyurethane
Suct. tube	-	-	-	480 mm	500 mm	500 mm	600 mm	600 mm

3 Follower plate



Art. 11/60

4 Adaptors

Choose the adaptor to be mounted on follower plate Art. 11/60 which must fit pump's suction tube diameter.

Art.
21/61



Art.
21/62



Art.
21/63



Art.
21/64



Art.
21/65





Product customisation



RAASM offers its customers the opportunity of ordering the products included in its range in different colours **among the 6 made available**.

They can be requested by customers **without minimum quantity requirements, or extra costs, choosing from the 5 additional colours to the standard colour** (RAASM green).

Customisation is characterised exclusively by the colour and **does not include:** instruction handbooks, labels, brands, etc.

Delivery times can vary with respect to standard colour products (RAASM green).

The above-mentioned customisation does not include the brake bleeders, pit and floor drainers, air-operated pumps, trolleys, service columns and accessories.

Requests for different colours, in addition to those made available, or other types of customisation, must be appraised from time to time and will be tied to minimum quantities and additional costs.

STANDARD COLOURS

Products for which a customised colour is not specified, are understood to be supplied with the standard colour as per the catalogue.

STANDARD



RAL 7035



To order an article with a colour **different from standard**, among the six made available, it is necessary to add the following to the article number

the suffix: /**GREEN** for green
 /**C1** for neutral
 /**C2** for yellow
 /**C4** for red
 /**C5** for blue

RAASM
Ral 7035
Ral 1004
Ral 3020
Ral 5002

OPPORTUNITY

RAASM offers its customers the opportunity of ordering articles in 4 different colours besides the standard one.

STANDARD



RAL 7035



RAL 1004



RAL 3020



RAL 5002





Guide to reading the SPARE PARTS CATALOGUE

↓ Exploded view

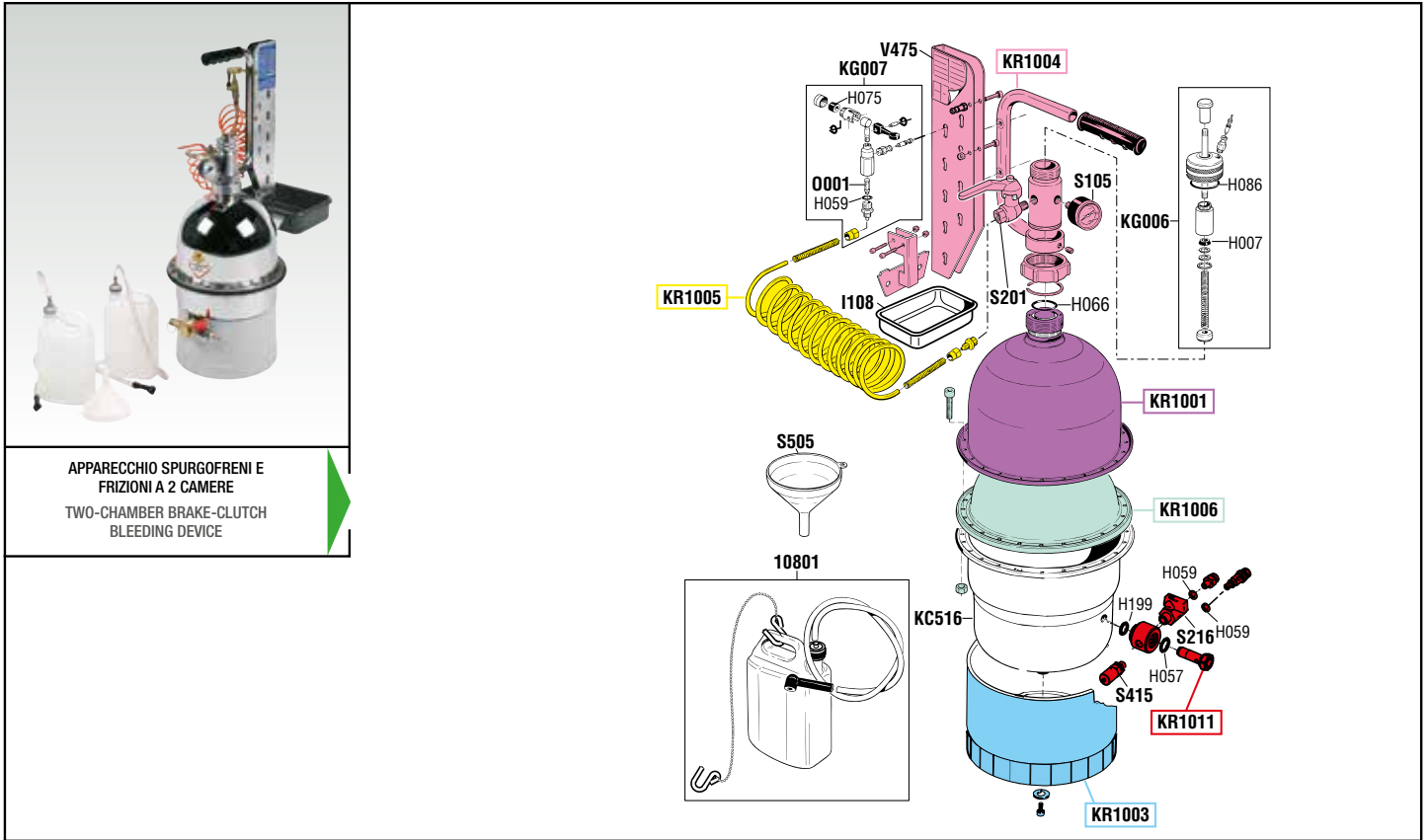

APPARECCHIO SPURGOFRENI E FRIZIONI A 2 CAMERE
TWO-CHAMBER BRAKE-CLUTCH BLEEDING DEVICE

↓ List of KR's (spare part kits) into which the article is divided. Every KR (e.g. KR1003) includes a distinct and homogeneous set of parts. A KR kit can be common to several articles.

↓ List of parts of the article supplyable individually

↓ The seal kit (e.g. KR1050) includes all the seals used in the article. This kit is not mentioned or shown in the exploded view.

KIT RICAMBI		
OGNI KIT SOTTO RIPORTATO COMPRENDE I RICAMBI EVIDENZIATI CON LO STESSO COLORE E LE RELATIVE GUARNIZIONI. QUESTI RICAMBI NON SONO FORNIBILI SEPARATAMENTE TRANNE QUELLI CODIFICATI.		
SPARE PARTS KITS		
EACH KIT SHOWN WITH THE SAME COLOR INCLUDES ALSO THE GASKETS. THE SPARE PARTS INCLUDED IN THE KIT CAN'T BE SUPPLIED SEPARATELY EXCEPT THOSE SHOWN WITH A PROPER CODE.		
CODICE CODE	DESCRIZIONE DESCRIPTION	Q.TÀ QTY
KR1001	CALOTTA SUPERIORE UPPER CAP	1
KR1003	PIEDISTALLO FOOT-STALL	1
KR1004	GRUPPO SUPERIORE COMPLETO COMPLETE UPPER GROUP	1
KR1005	TUBO COLLEGAMENTO CONNECTION HOSE	1
KR1006	MEMBRANA CON SET VITI MEMBRANE WITH SET OF SCREWS	1
KR1011	GRUPPO INFERIORE COMPLETO COMPLETE LOWER GROUP	1

ELENCO RICAMBI FORNIBILI SINGOLARMENTE		
LIST OF SPARE PARTS WHICH CAN BE SUPPLIED SEPARATELY		
CODICE CODE	DESCRIZIONE DESCRIPTION	Q.TÀ QTY
10801	TANICHETTA DI RECUPERO BRAKE FLUID COLLECTION CONTAINER	1
I108	VASCHETTA PORTA OGGETTI TOOL TRAY	1
KC516	SERBATOIO INFERIORE LOWER RESERVOIR	1
KG006	TAPPO CARICA OLIO OIL LEVEL INDICATOR	1
KG007	ATTACCO RAPIDO QUICK COUPLER	1
S105	MANOMETRO ø 50 mm GAUGE ø 50 mm	1
S201	RUBINETTO A SFERA 1/4" BALL VALVE 1/4"	1
S216	RUBINETTO A SFERA 1/4" BALL VALVE 1/4"	1
S415	VALVOLA DI SICUREZZA 3 bar SAFETY VALVE 3 bar	1
S505	IMBUTO RECUPERO OLIO FUNNEL	1
V475	ETICHETTA ELENCO TAPPI LABEL	1

Art. KR1050 KIT GUARNIZIONI COMPLETO		
COMPOSTO DALLE GUARNIZIONI SOTTO ELENCAE JOINTS GASKETS LIST INCLUDING ALL THE GASKETS SHOWN HERE UNDER		
CODICE CODE	DESCRIZIONE DESCRIPTION	Q.TÀ QTY
H007	GUARNIZIONE GASKET	1
H057	O-RING 2062 O-RING 2062	1
H059	O-RING 2037 O-RING 2037	1
H066	O-RING 3118 O-RING 3118	1
H068	O-RING 112 O-RING 112	1
H075	GUARNIZIONE ATTACCO RAPIDO QUICK CONNECTOR GASKET	1
H086	O-RING 4118 O-RING 4118	1
H199	O-RING 119 O-RING 119	1
0001	FILTRO ATTACCO RAPIDO QUICK CONNECTOR FILTER	1

A KS (e.g. KS1080) groups the spare parts (KR or single parts) given in the other tables. These are the spare parts recommended by the manufacturer, at the sales points and service centres, above all for first deliveries. Clearly, a KS cannot be shown in the exploded view

Art. KS1081 SET RICAMBI CONSIGLIATI		
AI PUNTI VENDITA E ASSISTENZA, COMPOSTO DAI RICAMBI SOTTO ELENCAE TO THE REPAIR CENTERS. THIS KIT INCLUDES ALL THE SPARE PARTS SHOWN HERE UNDER		
CODICE CODE	DESCRIZIONE DESCRIPTION	Q.TÀ QTY
KR1006	MEMBRANA CON SET DI VITI MEMBRANE WITH SET OF SCREWS	1
KR1050	KIT GUARNIZIONI COMPLETO COMPLETE GASKETS KIT	1
S105	MANOMETRO ø 50 mm GAUGE ø 50 mm	1



General sales terms



The following general sales conditions regulate the sale of goods and services by the company RAASM S.p.A. for customers residing outside the territory of the Italian State.

Art. 1 GOODS DELIVERY TERMS

The goods are delivered ex works RAASM S.p.A.. The subsequent transport / shipment must occur by, in the name and at the expense of the purchasing customer, even by means of carrier designated by the same. All risks arising from loading, subsequent custody and transport are borne entirely by the purchasing customer.

Art. 2 MINIMUM ORDERS

Each order cannot be for less than € 1.500,00, net of taxes, discounts and rebates. If, at the option of RAASM S.p.A., orders for lower amounts are accepted, an extra charge of € 155,00 shall be applied for order management administrative expenses.

Art. 3 ACCESSORIES

All the accessories given in the price list (plugs, oil bar taps, oil guns, grease guns, probes, protection caps, clutches, swivelling supports, etc.) are supplied exclusively for fitting to or combining with the items RAASM S.p.A. produces

Art. 4 COMPLAINTS

Any defects immediately noticed after a brief inspection of the goods (damage, shortages or different product from that ordered) must be notified in writing to our company within 8 (eight) days of receipt the goods. Any defects in the product noticeable only during its use must be notified in writing to RAASM S.p.A. within 8 (eight) days of being detected. Any returns of goods must be authorized in advance by RAASM S.p.A. and freight charges are at the customer's expenses.

Art. 5 DELIVERY TIMES/TERMS

Delivery times and dates are only approximate and are subject to change. Any delays in delivery do not entitle the customer to cancel the order or claim compensation for damages caused by delay of delivery. Delivery times for urgent orders must be agreed directly by RAASM S.p.A.. RAASM S.p.A. has the right not to carry out the order and/or totally or partially carry it out, without this giving rise to reimbursement or claims for compensation for damage.

Art. 6 PACKS AND PACKAGING

Packaging costs are included in the price, except for special packing, which shall be charged at cost.

Art. 7 PRICES

The current Price list cancels and replaces the previous price list. In the event of changes to our price list and/or individual items, the goods shall be forwarded at the price in force on the day of delivery. The price list and/or the prices of individual items can be changed even without notice, according to the changes in market conditions or technical innovations/modifications made to the product. The prices are understood to be ex works RAASM S.p.A.

Art. 8 PAYMENTS

Payments must be made exclusively to RAASM S.p.A. at the agreed conditions. Under no circumstances will deductions or roundings be accepted. In case of late payment with respect to the agreed conditions, RAASM S.p.A. reserves the right to charge interest at the current rate, effective from the day after that agreed for payment, plus any additional expenses. Discounts conditional on the payment term and already credited shall be recharged.

Art. 9 WARRANTY

RAASM S.p.A. provides each product with the communication of particular instructions for the installation, use and maintenance requirements and the need to carry out possible checks on the product. Incorrect installation, use or maintenance of the product shall void the warranty. The articles must be returned free to our Factory for checking and acceptance. All the technical information and data mentioned in the catalogue and in the price-list in force are not binding and can be changed without prior notice for the purpose of improving the quality of the products. All products manufactured by RAASM S.p.A. are guaranteed for a period of 5 (five) years. The 5 (five) year guarantee does not apply to components which are subject to normal wear and tear (such as gaskets, membranes, O-rings, hoses, etc), electronic components and items that are sold but not manufactured by RAASM S.p.A. (marked with a red asterisk in the current product catalogue) which are guaranteed for 1(one) year.

1 (one) year warranty is valid also for the following products:

- digital litre counters and FCS system;
- cable reels;
- electric, pneumatic or hydraulic motor supplied with our industrial hose reels S. 600 and 700.

Art. 10 RESPONSIBILITY

RAASM S.p.A. is exempt from any responsibility and liability for accidents that may occur to persons and property, as a result of or during the use of the equipment, due to or depending on the same whenever the products have been damaged during transport, tampered with or modified, or improperly used, or stored, installed, protected and preserved without complying with the instructions of RAASM S.p.A. as given in the installation, use and maintenance instruction manuals for each product. RAASM S.p.A. is liable for the value for the supplied product and cannot be held responsible in any way for other possible costs or additional costs that the customer may bear.

Art. 11 COMPETENT LAW COURT

Any disputes shall be settled by the Law Court of Vicenza, Italy.



How to reach RAASM



by plane

With regular flights, the nearest airports are those Venice Tessera, Verona Villafranca and Treviso.

- **FROM VENICE TESSERA**
Bassano can be reached by train:
Venice - Padova - Cittadella
Bassano del Grappa.
- **FROM VERONA VILAFRANCA**
Bassano can be reached by train:
Dossobuono - Verona - Vicenza
Cittadella - Bassano del Grappa.
- **FROM TREVISO**
Bassano can be reached by train:
Treviso - Castelfranco - Cassola.



by train

RAASM can be reached also by train, getting off at Bassano del Grappa station.

- **BOLZANO:** Bolzano - Verona
Vicenza - Cittadella - Bassano del
Grappa.
- **MILAN:** Milan - Verona - Vicenza
Cittadella - Bassano del Grappa.
- **BOLOGNA:** Bologna - Padova
Cittadella - Bassano del Grappa.
- **TRIESTE - UDINE:** Trieste - Udine
Codroipo - Treviso - Castelfranco
Bassano del Grappa.

**RAASM is approx. 3 km
from the Train Station.**



by own transport

Arriving by car from the north or west, with Verona as the reference point take the A4 Motorway towards Vicenza - Valdastico. At the Dueville exit head for Bassano del Grappa.

If arriving from the south, with Padova as the reference point take State Road 47 towards Cittadella Bassano del Grappa.



Notes

A spiral-bound notebook page with a black metal spiral binding on the right side. The page is white and features horizontal ruling lines spaced evenly down its length. The top of the page is slightly curved, following the spiral binding.

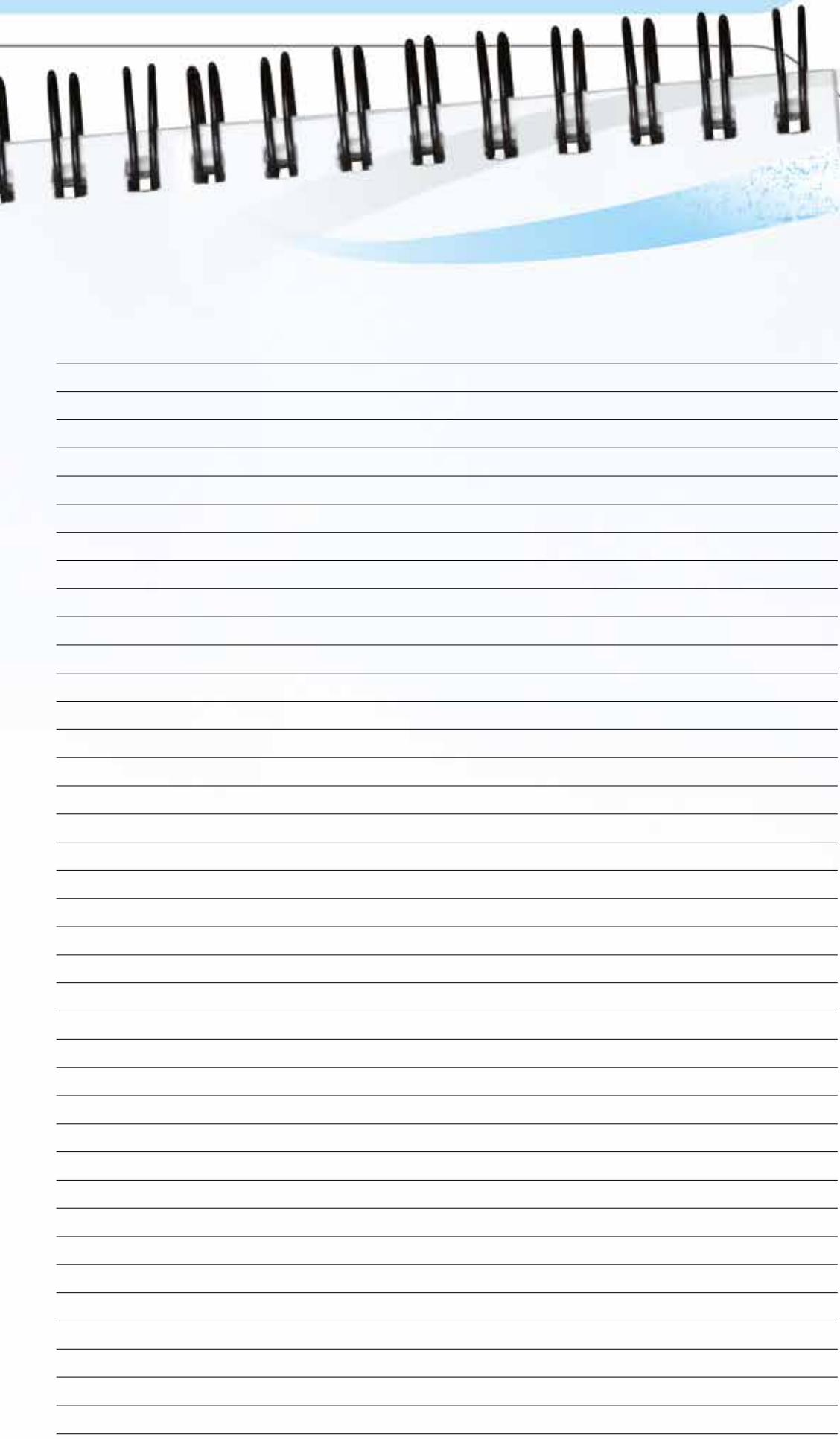

RAASIA

Index Articles

Article	219 Catalogue page No.	217 Catalogue page No.
10/09	204-210	323
10/10	107-210	225-322
10/11	107-210	225-322
10/12	210	225-322
10/13	210	225-322
10/14	107-210	323
10/15	107-210	224-323
10/17	210	323
10/18	210	225-323
10/20	112	234-325
10/21	112	
10/22	112	234-325
10/23	112	234-325
10/24	112	234-325
10/25	112	
10/50	126-211	260-324
10/51	126-211	260-324
10/52	126-211	260-324
10/55	211	324
10/56	211	324
10/57	211	324
10/60	126-211	258-325
10/61	126-211	258-325
10/62	126-211	258-325
10/65	211	325
10/66	211	325
10/67	211	325
10/80	212	327
10/81	212	327
10/82	213	261-328
10/85	213	329
10/09111P1N	215	
10/09451P1N	215	
10/12181P1N	215	
10/12401P1N	215	
10/12751P1N	215	
10/1561P1N	214	
10/15701P1N	215	
10/1881P1N	214	
10105	32	48
10205	32	48
10207	32	48
10705	32	49
10801	35	51
10802	35	51
10805	32	49
10807	32	49
11/60	216	329
11000/A	34	50
11000/B	34	50
11000/C	34	50
11000/D	34	50
11000/E	34	50
11000/F	34	50
11000/G	34	50
11000/H	34	50
11000/I	34	50
11000/K	34	50
11000/L	34	50
11000/M	34	50
11000/P	34	50

Article	219 Catalogue page No.	217 Catalogue page No.
11000/R	34	50
11000/T	34	50
11000/U	34	50
11000/W	34	50
11000/X	34	50
11000/Y	34	50
11000/Z	34	50
11001	34	50
11002	34	50
11003	35	51
11003/1	35	51
11003/2	35	51
11003/3	35	51
11003/4	35	51
11003/5	35	51
11003/6	35	51
11003/7	35	51
11003/8	35	51
11003/9	35	51
11004	35	51
115D/121	207	307
115D/181	207	308
115D/31	200	315
115D/91	207	306
115DV/31	200	315
115F/121	199	307
115F/181	199	308
115F/401	204	312
115F/751	203	311
115F/91	199	306
115FSP/751	203	
116F/121	199	307
116F/181	199	308
116F/401	205	312
116F/751	119-203	311
117F/401	205	312
117F/751	119-203	311
118F/401	204	
118FSP/401	204	
120D/91	209	321
150D/41	201	316
150D/61	201	317
150DV/61	201	317
150F/701	205	
151F/701	205	313
152F/701	205	313
153F/701	205	
153FSP/701	205	
180D/51	201	318
180D/81	201	319
180DV/81	201	319
21/61	216	
21/62	216	
21/63	216	
21/64	216	
21/65	216	
22017	36	54
22024	36	54
23024	36	55
23025	36	55
24891	36-60-62	55-116

Article	219 Catalogue page No.	217 Catalogue page No.
26090	70	160
26091	70	160
26093	70	
26094	70	160
2B3/16117NH52	79	
2B3/16117TT52	79	
2B8/16117NH52	79	
2B8/16117TT52	79	
30050	61	115
30200	60	115
31200	60	114
31201	60	114
32016	61	116
32024	61	116
32065	61	116
32713	60-62	
33/2011NHHV2	77	
33/2611NHHV2	78	
33/3011NHHV2	78	
33016	62	120
33024	62	120
33060	71	163
33061	71	163
33070	71	163
33071	71	163
33072	71	163
33073	71	163
33080	71	162
33081	71	162
33082	71	162
33083	71	162
33094	71	163
33096	71	163
33106	108	
33107	108	
33108	108	
33109	108	
33111	108	
33112	108	226
33113	108	226
33114	108-182	403
33115	107-210	224
33116	108-182	226-403
33117	108-182	226-403
33118	108	226
33119	108-182	226-403
33120	98	210
33121	99	212
33122	106	223
33125	50-90	186
33126	108	186-226
33127	108	186-226
33128	182	403
33129	182	403
33130	182	403
33131	182	
33132	182	
33133	182	
33134	50-90	
33140	100	216
33146	102	

Article	219 Catalogue page No.	217 Catalogue page No.
33147	102	
33148	102	
33150	102-105	218-222
33151	102	218
33152	102	218
33153	102	218-326
33160	71	165
33170	71	164
33172	71	164
33173	71	164
33194	71	165
33196	71	165
33270	182	403
33271	182	403
33272	182	403
33273	182	403
33274	182	403
33275	108	226
33276	108	226
33277	108	
33300	76	159
33360	76-208	158
33396	76-208	158
33424	111	
33425	111	
33426	110-111	228
33427	111	227
33428	111	
33434	107-111 210	224
33445	76-103 208	
33446	103	
33500	77	156
33501	92	201
33505	77	
33550	50-90	186
33581	111	227
33582	111	227
33583	111	
33585	111	
33590	107	225
33591	107	225
35060	72	161
35061	72	161
35063	72	
35076	73	
35094	73	161
35160	73	166
35161	73	166
35163	73	167
35173	73	167
35176	73	167
35194	73	167
35196	73	167
35198	83	
35199	83	
35200	82	172
35201	82	
35209	82	
35210	82	173

Index Articles

Article	219 Catalogue page No.	217 Catalogue page No.
---------	------------------------------	------------------------------

35219	83	
35220	83	174
35249	85	
35250	85	175
35254	85	
35259	85	
35260	85	
35264	85	
35265	84	176
35270	84	177
35275	86	180
35276	87	181
35280	87	182
35281	87	183
35284	91	
35285	91	185
35290	91	178
35293	91	178
35296	91	178
35330	88	190
35415	83	
35425	83	
36060	74	168
36061	74	168
36063	74	169
36073	75	169
36076	75	169
36094	75	169
36096	75	169
36330	88	190
36340	89	191
36350	89	191
36602	89	194
36603	89	
36604	89	
36610	89	196
36620	89	196
37095	83	
37099	83	
37100	82	172
37150	82	173
37200	83	174
37499	85	
37500	85	175
37504	85	
37650	84	176
37670	84	177
37675	86	180
37676	87	181
37679	87	183
37680	87	182
37683	93	200
37685	91	185
37686	92	198
37687	92	198
37688	92	198
37689	92	198
37690	92	198
37691	92	198
37692	93	202
37693	93	202

Article	219 Catalogue page No.	217 Catalogue page No.
---------	------------------------------	------------------------------

37695	92	201
37697	93	200
37698	93	200
37699	93	200
37701	106	204
37703	106	206
37704	106	
37728	98	
37729	98	
37730	98	
37740	99-104	214-220
37741	99	214
37742	99	214
37743	99	214
37750	100-104	216-221
37751	100	216
37752	100	216
37758	99	
37759	99	
37760	99	
37762	103	
37764	103	
37775	101-105	
37776	101	
37777	101	
37778	101	
37780	94	
37781	94	
37785	94-103	
37786	99	
37794	100	
37795	100	
37796	100	
37797	101	
37798	101	
37799	101	
37801	129	264
37810	129	264
37811	129	264
37812	110-129	229-264
37814	129	264
37815	129	264
37816	129	264
37817	110-129	229-264
37830	93	
38010	104	220
38011	104	220
38012	104	220
38013	104	220
38014	104	
38015	104	220
38016	104	220
38017	104	220
38018	104	220
38020	99-104	212-220
38021	99	212
38022	99	212
38023	98-104	210-220
38024	98	210
38025	98	210
38026	110	228

Article	219 Catalogue page No.	217 Catalogue page No.
---------	------------------------------	------------------------------

38027	111	227
38028	110	228
38029	104	221
38030	104	221
38031	104	221
38032	104	221
38034	104	221
38035	104	221
38037	105	222
38038	105	222
38039	105	222
38040	105	222
38042	107	224
38043	107	224
38044	107	
38046	107	224
38047	107	224
38051	107	224
38052	107	224
38055	111	227
38056	111	
38057	111	
38062	104	220
38063	104	221
38065	105	222
38066	105	
38069	108	
38070	108	226
38071	108-182	226-403
38072	108-182	226-403
38073	108-182	226
38075	108	226
38076	108	226
38077	108	226
38078	108	226
38079	108	
38080	110	
38081	110	
38082	110	
38083	110	
38084	113	232
38085	113	232
38086	113	232
38087	113	232
38088	113	232
38089	113	233
38090	112	234
38091	110	226
38092	112	234
38093	113	233
38095	110	229
38096	110	229
38097	109	229
38098	109	229
38099	110	229
38100	110	229
38102	93	202
38105	93	202
38120	182	403
38121	182	403
38124	182	

Article	219 Catalogue page No.	217 Catalogue page No.
---------	------------------------------	------------------------------

38130	109	
38131	109	
38132	109	
38210	110	228
38211	110	228
39304	139	277
39307	139	277
39314	139	273
39317	139	273
39320	135	99
39321	135	279
39322	135	279
39323	134	
39324	137	275
39328	137	275
39334	134	
39335	134	
39336	136	
39338	136	
39340	136	
39351	138	281
39352	138	281
39405	139	
39406	139	
39407	139	
39421	135	
39422	135	
39901	138	282
39902	138	282
42000	51	66
42004	51	
42050	51	66
42055	52	
42056	52	
42059	52	64
42060	52	64
42061	52	64
42062	52	64
42065	46	68
42066	46	72
42069	53	65
42070	53	65
42072	53	65
42073	53	65
42075	53	
42076	53	
42090	46	68
42091	46	72
42115	46	68
42116	46	72
43016	45	79
43024	45	79
43060	47	80
43065	47	82
43090	47	80
43091	47	82
43114	47	80
43115	47	82
44060	47	84
44065	47	86
44090	47	84

Index Articles

Article	219 Catalogue page No.	217 Catalogue page No.
---------	------------------------	------------------------

44091	47	86
44115	47	84
44116	47	86
45100	55	97
45110	55	97
45111	55	97
45150	54	96
45180	54	96
45200	56	104
45250	56	104
45280	56	104
45290	56	104
45291	56	104
45292	56	104
45300	55	98
45310	55	99
45311	55	99
45498	44	100
45499	44	100
45500	44	100
45501	44	100
45502	44	100
45504	44	100
45505	44	100
45506	44	100
45515	44	100
45516	44	100
45517	44	100
45518	44	100
45526	44	100
45527	44	100
45528	44	100
45538	44	100
45539	44	100
45540	44	100-106
45550	44	101-109
45551	44	101-109
45560	44	100
45570	44	101
46064	48	90
46065	48	90
46114	49	91
46115	49	91
46116	49	92
46215	49	94
52010	39	60
52013	38	58
52015	38	59
52020	38	58
52024	38	59
53016	38	59
53024	38	59
60280	64	124
60310	64	124
60311	64	124
60410	65	126
60411	65	126
60450	65-127	126-262
60451	65-127	126-262
62041	116	238
62048	116	238

Article	219 Catalogue page No.	217 Catalogue page No.
---------	------------------------	------------------------

62074	116	238
62095	116	238
63041	117	239
63048	117	239
63074	117	239
63095	117	239
64000	121	242
64000/65	121	242
64000/75	121	242
64001	121	
64001/65	121	
64001/75	121	
64021	125	251
64025	125	250
64031	125	251
64032	124	249
64033	124	249
64033/40	125	249
64034	124	248
64035	124	248
64036	125	248
64037	123	246
64038	123	246
64039	123	247
64039/65	123	247
64040	123	244
64041	123	244
64042	123	245
64042/65	123	245
64063	122	244
64064	122	244
64070	120	243
64070/65	120	243
64070/75	120	243
64071	121	
64071/65	121	
64071/75	121	
64145	122	256
64146	122	256
64195	120	257
64196	120	257
64197	120	257
64200	117	254
64210	117	255
65138	108-211	229-324
65142	108-211	229-324
65160	108-211	229-324
65280	126	260
65309	127	260
65310	126	260
65311	127	260
65312	127	
65350	126	260
65385	126	260
65420	126	260
65600	126	260
66265	126	258
66310	126	258
66340	126	258
66370	126	258
66400	126	258

Article	219 Catalogue page No.	217 Catalogue page No.
---------	------------------------	------------------------

66590	126	258
66599	127	263
66661	127	262
66663	127	262
66739	127	263
66740	127	263
66741	127	263
66742	127	263
66743	127	263
66855	128	266
66856	128	267
66857	128	267
66860	128	266
66880	128	267
66881	128	267
66882	128	267
66888	128	266
66889	128	266
66891	127-182	262
66892	127-182	262
66893	127-182	262-403
66895	127	262
66896	127	262
66897	127	262
68012	63	122
68113	63	122
68213	63	123
70365	37	56
70809	37	56
735000	177	
735111	177	
735131.60141	177	
735131.60152	177	
735131.60252	177	
735131.60261	177	
735141.60152	177	
735141.60252	177	
7522001.100	176	
7522001.150	176	
7522001.200	176	
7522001.250	176	
7522001.300	176	
7522001.400	176	
7522001.450	176	
7532001.100	176	
7532001.150	176	
7532001.200	176	
7532001.250	176	
7532001.300	176	
7532001.400	176	
7532001.450	176	
7552001.100	176	
7552001.150	176	
7552001.200	176	
7552001.250	176	
7552001.300	176	
7552001.400	176	
7552001.450	176	
7562001.100	176	
7562001.150	176	
7562001.200	176	

Article	219 Catalogue page No.	217 Catalogue page No.
---------	------------------------	------------------------

7562001.250	176	
7562001.300	176	
7562001.400	176	
7562001.450	176	
80035	130	270
80040	130	270
80050	130	270
80200	131	271
80201	131	271
80210	131	
80215	131	
8288.100	149	
8288.102	149	
8288.103	149	
8288.104	149	
8288.105	149	
8290.100	154	
8290.101	154	
8290.104	154	
8292.100	155	
8292.101	155	
8292.104	155	
8328.100	149	
8328.102	149	
8328.103	149	
8328.104	149	
8328.105	149	
8330.100	154	
8330.101	154	
8330.200	156	
8330.201	156	
8330.300	158	
8330.301	158	
8330.350	160	
8330.400	164	
8330.402	164	
8330.500	166	
8330.501	166	
8330.800	173	
8330.801	173	
8330.802	173	
8332.100	155	
8332.101	155	
8332.201	157	
8332.300	159	
8332.301	159	
8332.350	161	
8332.400	157	
8333.202	157	
8333.301	159	
8378.100	149	
8378.102	149	
8378.103	149	
8378.104	149	
8378.105	149	
8380.100	154	342
8380.102	154	342
8380.200	156	350
8380.202	156	350
8380.300	158	356
8380.302	158	356

Index Articles

Article	219 Catalogue page No.	217 Catalogue page No.
---------	------------------------	------------------------

8380.350	160	360
8380.352	160	360
8380.400	164	372
8380.401	164	372
8380.402	164	372
8380.500	166	380
8380.501	166	380
8380.502	166	380
8382.100	155	343
8382.102	155	343
8382.200	157-165	351-373
8382.202	157	351
8382.300	159	357
8382.302	159	357
8382.350	161	361
8382.352	161	361
8382.500	167	381
8383.201	157	351
8383.301	159	357
8390.100	154	340
8390.102	154	340
8390.200	156	348
8390.202	156	348
8390.300	158	354
8390.302	158	354
8390.350	160	358
8390.352	160	358
8390.400	164	370
8390.401	164	370
8390.402	164	370
8390.500	166	378
8390.501	166	378
8390.502	166	378
8390.800	173	
8390.801	173	
8390.802	173	
8392.100	155	341
8392.102	155	341
8392.200	157-165	349-371
8392.202	157	349
8392.300	159	355
8392.302	159	355
8392.350	161	359
8392.352	161	359
8392.500	167	379
8393.201	157	349
8393.301	159	355
8420.100	154	342
8420.101	154	342
8420.102	154	342
8420.103	154	342
8420.104	154	342
8420.200	156	350
8420.201	156	350
8420.202	156	350
8420.300	158	356
8420.301	158	356
8420.302	158	356
8420.350	160	360
8420.354	160	360
8420.400	164	372

Article	219 Catalogue page No.	217 Catalogue page No.
---------	------------------------	------------------------

8420.401	164	372
8420.402	164	372
8420.500	166	380
8420.501	166	380
8420.502	166	380
8420.505	166	380
8420.506	166	380
8422.100	155	343
8422.101	155	343
8422.102	155	343
8422.103	155	343
8422.104	155	343
8422.201	157	351
8422.202	157	351
8422.301	159	357
8422.302	159	357
8422.354	161	361
8422.500	167	381
8423.202	157	351
8423.302	159	357
8423.354	161	361
8424.200	157-162 165	351-363 365-373
8424.300	159-162	357-367
8424.350	161-162	361-369
8430.100	149-154	340
8430.1000	171	
8430.101	154	340
8430.102	154	340
8430.103	154	340
8430.104	154	340
8430.200	156	348
8430.201	156	348
8430.202	156	348
8430.300	158	354
8430.3000	171	
8430.301	158	354
8430.302	158	354
8430.350	160	358
8430.354	160	358
8430.400	164	370
8430.4000	171	
8430.401	164	370
8430.402	164	370
8430.500	166	378
8430.501	166	378
8430.502	166	378
8430.505	166	378
8430.506	166	378
8430.700	172	390
8430.701	172	390
8430.702	172	390
8430.800	173	392
8430.802	173	392
8430.804	173	392
843001	180	394
843002	180	394
843005	181	395
843006	181	395
8432.100	155	341

Article	219 Catalogue page No.	217 Catalogue page No.
---------	------------------------	------------------------

8432.101	155	341
8432.102	155	341
8432.103	155	341
8432.104	155	341
8432.201	157	349
8432.202	157	349
8432.301	159	355
8432.302	159	355
8432.354	161	359
8432.500	167	379
8433.202	157	349
8433.302	159	355
8433.354	161	359
8434.200	157-162 165	349-362 364-371
8434.300	159-162	355-366
8434.350	161-162	359-368
8436.200	170	
8436.204	170	
8436.205	170	
8438.101	149	
8438.102	149	
8440.100	150	344
8440.101	150	344
8440.102	150	344
8440.103	150	344
8440.104	150	344
8440.400	150	374
8440.401	150	374
8440.402	150	374
8440.500	150	382
8440.501	150	382
8440.502	150	382
8440.505	150	382
8440.506	150	382
8450.100	150	344
8450.101	150	344
8450.102	150	344
8450.103	150	344
8450.104	150	344
8450.400	150	374
8450.401	150	374
8450.402	150	374
8450.500	150	382
8450.501	150	382
8450.502	150	382
8450.505	150	382
8450.506	150	382
845001	180	394
845005	181	395
8520.100	154	342
8520.101	154	342
8520.102	154	342
8520.200	156	350
8520.201	156	350
8520.300	158	356
8520.301	158	356
8520.302	158	356
8520.350	160	360
8520.352	160	360
8520.400	164	372

Article	219 Catalogue page No.	217 Catalogue page No.
---------	------------------------	------------------------

8520.401	164	372
8520.402	164	372
8520.500	166	380
8520.501	166	380
8520.502	166	380
8522.100	155	343
8522.101	155	343
8522.102	155	343
8522.201	157	351
8522.301	159	357
8522.302	159	357
8522.352	161	361
8522.500	167	381
8523.202	157	351
8523.302	159	357
8523.352	161	361
8524.200	157-162 165	351-363 365-373
8524.300	159-162	357-367
8524.350	161-162	361-369
8530.100	154	340-386
8530.1000	171	
8530.101	154	340
8530.102	154	340
8530.200	156	348
8530.201	156	348
8530.300	158	354
8530.3000	171	
8530.301	158	354
8530.302	158	354
8530.350	160	358
8530.352	160	358
8530.400	164	370
8530.4000	171	
8530.401	164	370
8530.402	164	370
8530.500	166	378
8530.5000	171	
8530.501	166	378
8530.502	166	378
8530.600	168	
8530.603	168	
8530.604	168	
8530.700	172	390
8530.701	172	390
8530.702	172	390
8530.703	172	390
8530.704	172	390
8530.705	172	390
8530.800	173	392
8530.802	173	392
8530.804	173	392
853001	180	394
853002	180	394
853005	181	395
853006	181	395
8532.100	155	341-387
8532.101	155	341
8532.102	155	341
8532.201	157	349
8532.301	159	355

Index Articles

Article	219 Catalogue page No.	217 Catalogue page No.
---------	------------------------------	------------------------------

8532.302	159	355
8532.352	161	359
8532.500	167	379
8533.202	157	349
8533.302	159	355
8533.352	161	359
8534.200	157-162 165	349-362 364-371
8534.300	159-162	355-366
8534.350	161-162	359-368
8537.200	170	
8537.204	170	
8537.205	170	
8540.100	154-168	340-386
8540.101	154	340
8540.102	154	340
8540.103	154	340
8540.105	154	340
8540.106	154	340
8540.200	156	348
8540.202	156	348
8540.203	156	348
8540.300	158	354
8540.301	158	354
8540.350	160	358
8540.400	164	370
8540.411	164	
8540.412	164	
8540.413	164	
8540.405	164	370
8540.406	164	370
8540.500	166	378
8540.5000	171	
8540.501	166	378
8540.601	168	386
8540.602	168	386
8540.603	168	386
8540.700	172	390
8540.701	172	390
8540.702	172	390
8540.704	172	390
8540.705	172	390
8540.707	172	390
8540.709	172	390
8540.800	173	392
8540.802	173	392
854001	180	394
854002	180	394
854005	181	395
854006	181	395
8542.100	155-169	341-387
8542.101	155	341
8542.102	155	341
8542.103	155	341
8542.105	155	341
8542.106	155	341
8542.202	157	349
8542.203	157	349
8542.301	159	355
8542.601	169	387

Article	219 Catalogue page No.	217 Catalogue page No.
---------	------------------------------	------------------------------

8542.602	169	387
8542.603	169	387
8543.202	157	349
8543.301	159	355
8544.200	157-162 165	349-362 364-371
8544.205	162	349-362 364-371
8544.300	159-162	355-366
8544.350	161-162	359-368
8545.200	163	
8550.100	154	342
8550.101	154	342
8550.102	154	342
8550.103	154	342
8550.105	154	342
8550.106	154	342
8550.200	156	350
8550.202	156	350
8550.203	156	350
8550.300	158	356
8550.301	158	356
8550.350	160	360
8550.400	164	372
8550.411	164	
8550.412	164	
8550.413	164	372
8550.405	164	372
8550.406	164	372
8550.500	166	380
8550.501	166	380
8552.100	155	343
8552.101	155	343
8552.102	155	343
8552.103	155	343
8552.105	155	343
8552.106	155	343
8552.202	157	351
8552.203	157	351
8552.301	159	357
8553.202	157	351
8553.301	159	357
8554.200	157-162 165	351-363 365-373
8554.205	162	351-363 365-373
8554.300	159-162	357-367
8554.350	161-162	361-369
8560.100	154-168	340-386
8560.101	154	340
8560.103	154	340
8560.104	154	340
8560.105	154	340
8560.106	154	340
8560.200	156	348
8560.205	156	348
8560.300	158	354
8560.301	158	354
8560.302	158	354
8560.350	160	358
8560.400	164	370

Article	219 Catalogue page No.	217 Catalogue page No.
---------	------------------------------	------------------------------

8560.415	164	
8560.603	168	386
8560.604	168	386
8560.605	168	386
856001	180	394
856002	180	394
8562.100	155-169	341-387
8562.101	155	341
8562.103	155	341
8562.104	155	341
8562.105	155	341
8562.106	155	341
8562.205	157	349
8562.301	159	355
8562.302	159	355
8562.603	169	387
8562.604	169	387
8562.605	169	387
8564.200	157-162	349-362 364-371
8564.206	162	349-362 364-371
8564.300	159-162	355-366
8564.350	161-162	359-368
8617.100	174	346
8617.200	174	352
8617.400	174	376
8617.500	174	384
8617.600	174	388
8618.100	175	347-389
8618.200	175	353
8618.400	175	377
8618.500	175	385
8637.100	174	346
8637.200	174	352
8637.400	174	376
8637.500	174	384
8637.600	174	388
8638.100	175	347-389
8638.200	175	353
8638.400	175	377
8638.500	175	385
88630	86-108 134-137 147	203-265
88650	147	397
88651	147	397
89001	39-148	60-338
89010	148	338
89011	148	338
89109	148	339
89110	148	339
90C/111	81-198	304
90C/51	80-196	170-301
90C/71	81-197	171-302
90D/111	207	305
90D/21	200	314
90D/51	206	301
90D/71	206	303
90DV/21	200	314
90F/111	199	305

Article	219 Catalogue page No.	217 Catalogue page No.
---------	------------------------------	------------------------------

90F/451	118-202	240-309
90F/51	196	170-301
90F/71	197	171-303
90FSP/451	202	
91C/111	81-198	304
91C/701	119-203	241-310
91C/71	81-197	171-302
91F/111	199	305
91F/451	118-202	240-309
91F/71	197	171-303
92C/111	81-198	305
92C/701	203	
92C/71	81-197	303
92F/451	202	309
93C/71	197	
9430.100	152	
9430.101	152	
9430.102	152	
9430.103	152	
9430.104	152	
9430.200	152	
9430.201	152	
9430.202	152	
9430.300	152	
9430.301	152	
9430.302	152	
9430.400	152	
9430.401	152	
9430.402	152	
9430.500	152	
9430.501	152	
9430.502	152	
9430.505	152	
9430.506	152	
9431.202	152	
9431.302	152	
9432.100	153	
9432.101	153	
9432.102	153	
9432.103	153	
9432.104	153	
9432.201	153	
9432.202	153	
9432.301	153	
9432.302	153	
9432.401	153	
9432.402	153	
9432.500	153	
9432.501	153	
9432.502	153	
9432.505	153	
9432.506	153	
9433.202	153	
9433.302	153	
9434.200	153	
9434.300	153	
9450.100	151	
9450.101	151	
9450.102	151	
9450.103	151	
9450.104	151	

Index Articles

Article	219 Catalogue page No.	217 Catalogue page No.
9450.400	151	
9450.401	151	
9450.402	151	
9450.500	151	
9450.501	151	
9450.502	151	
9450.505	151	
9450.506	151	
94D/61	209	
95D/61	209	320
967.206	183	
967.210	186	
967.215	186	
971.010	184	
971.011	184	405
971.015	184	
971.102	183	404
971.111	184	405
971.115	184	
971.118	184	
971.120	184	
972.102	183	
972.113	184	
972.115	184	
972.120	184	
973.913	186	409
973.917	186	409
973.920	186	409
973.925	186	409
973.930	186	409
974.1008	186	
974.1015	186	409
974.1020	186	409
974.1028	186	409
974.912	186	409
974.915	186	409
974.920	186	409
974.925	186	409
974.930	186	409

Article	219 Catalogue page No.	217 Catalogue page No.
975.1002	183	404
975.1010	186	
975.1015	186	
975.1018	186	409
975.1027	186	409
975.1030	186	409
975.902	183	404
975.915	186	409
975.920	186	409
975.927	186	409
976.102	183	
976.108	184	
976.110	184	
976.111	184	
976.112	184	
976.114	184	
976.115	184	
993.201	110-127 183	404
993.202	110-127 183	404
993.215	184	
993.504	127-183	404
993.511	185	408
993.512	127-185	408
993.516	185	408
993.518	127-185	408
994.512	185	406
994.517	185	406
994.612	185	406
994.717	185	406
995.206	183	404
995.210	184	
995.211	184	405
995.212	184	405
995.217	184	405
995.218	184	405
995.312	185	408
995.313	184	405

Article	219 Catalogue page No.	217 Catalogue page No.
995.317	185	408
995.318	184	405
995.412	184	405
995.506	183	404
995.512	185	406
995.518	185	406
995.520	185	406
995.525	185	406
995.530	185	406
995.540	185	406
995.550	185	406
995.606	183	404
995.618	185	406
995.625	185	406
995.630	185	406
995.701	127-183	404
995.702	127-183	404
995.706	183	404
995.710	127-185	408
995.715	127-185	408
995.720	185	408
995.725	185	408
995.730	185	408
995.806	183	404
995.815	185	406
995.825	185	406
995.906	183	404
995.915	185	406
995.925	185	406
996.210	184	405
996.215	184	405
996.220	184	405
996.225	184	405
996.230	184	405
996.301	110-183	404
996.302	110-183	404
996.304	110-183	404
996.306	183	404
996.310	185	408

Article	219 Catalogue page No.	217 Catalogue page No.
996.311	184	405
996.315	185	408
996.316	184	405
996.320	185	408
996.321	184	405
996.325	185	408
996.330	185	408
996.406	183	404
996.415	184	405
996.425	184	405
997.215	184	405
997.220	184	405
997.230	184	405
997.240	184	405
997.320	184	405
997.420	184	405
997.505	110-183	404
997.3315	185	
997.3320	185	
997.812	186	
997.815	186	409
997.820	186	409
997.840	186	409
998.215	184	405
998.220	184	405
998.230	184	405
998.315	184	405
998.330	184	405
998.406	183	404
998.501	110-183	404
998.502	110-183	404
998.3306	183	
998.3315	185	
998.3330	185	
998.808	186	
998.815	186	409
998.820	186	409
998.830	186	409



The manufacturer declines all responsibility for possible imprecisions contained in this catalogue, due to misprints or clerical errors.

Moreover, the manufacturer reserves the right to bring about any technical-functional and design change or improvement, without any previous notice and with the utmost operational freedom.

FLUIDS AND LUBRICATION EQUIPMENT

RAASM



THREE WORDS TO DESCRIBE RAASM

■ Technology

The starting point for the entire production cycle is the research and development of cutting-edge new solutions which lead to the development of **high quality products, fully produced in Italy.**



■ Quality

The quality of our product manufacturing has always been our absolute priority. To reach this goal rigorous testing accompanies every phase of the manufacturing process.



■ Functionality

RAASM offers the most complete range of lubrication products suited to many sectors. Our aim is to always be available to provide solutions to our customers.



All rights reserved to Raasm S.p.A.

Authorized distributor



Company with quality and environment system according to ISO 9001:2015 and ISO 14001:2015 standards

RAASM S.p.A.
36022 S. ZENO DI CASSOLA (VI)
Via Marangoni, 33 - ITALY

Export department
Tel. +39 0424 571130 - Fax +39 0424 571135

Technical department
Tel. +39 0424 571150 - Fax +39 0424 571155
info@raasm.com - www.raasm.com

